

TOP DEAL

KSTOOLS

WWW.KSTOOLS.COM

No Limits!

NAŠA KLJUČNA KOMPETENTNOST:

KVALITET PO NAJBOLJOJ CENI!

EVOLUTION
SERIES



Kompletna
specifikacija

917.0255

1/4" + 3/8" + 1/2" + 5/16"

255 DELOVA
ZA SAMO

15830,-

i **397**
Ostale informacije

P₁₀

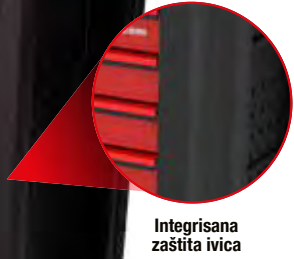
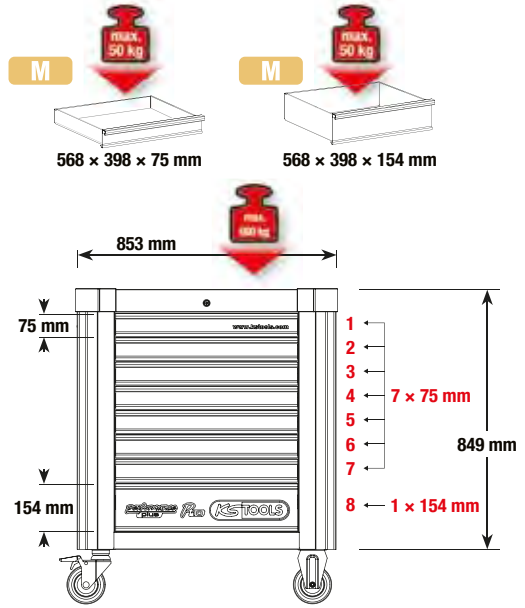

IZABERITE SVOJ POWER PAKET

810.7397

i **397**
Ostale informacije

med Držač papirnih rolni sa držač za doze Stabilni kuglični ležaj antistatički točkovi sa kočnicom

P₁₅

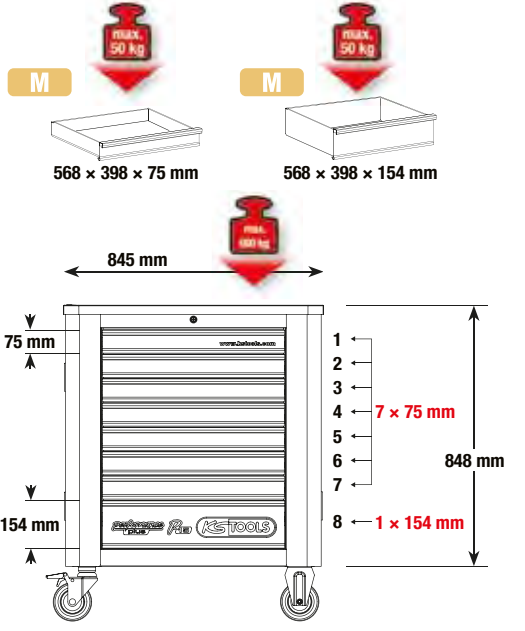

815.7397

SAVRŠENI PAKET SA 397 DELOVA

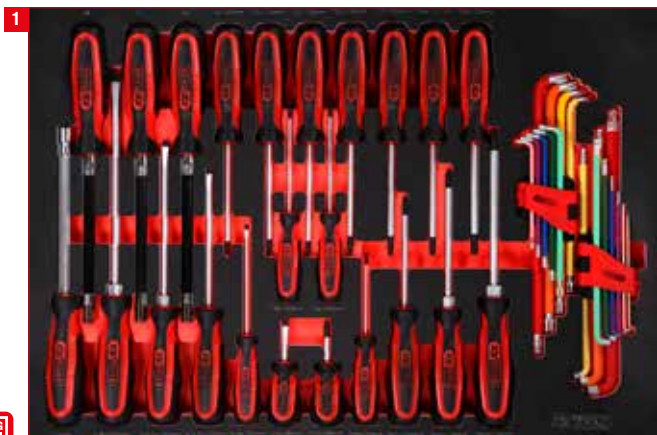

41
Odvijač-set



41
Set odvijača

356270,-

810.7397 P10 radionička kolica sa 397 alata



111
1/4" + 3/8" + 1/2" utični ključ-set

369470,-

815.7397 P15 radionička kolica sa 397 alata



111
1/2" set bit nasadnih ključeva



28
Set klešta i turpija



43
Set za servisiranje ulja i guma



22
Set čekića i dleta

DOBRODOŠLI U



Ostale informacije



501470,-

POSEBNO ŠIROKO

Ø 125 mm



Integrirana zaštitna ivica



sa držač za doze



Stabilni kuglični ležaj



antistatički točkovi sa kočnicom



brava može da se zaključa

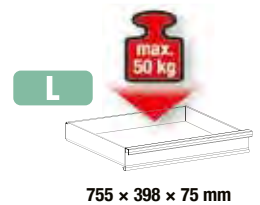
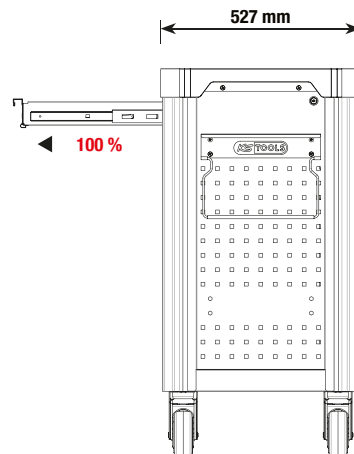
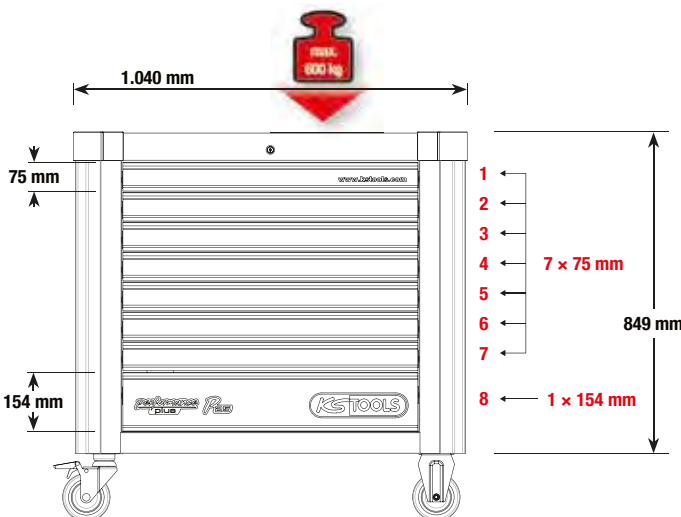

755 × 398 × 75 mm

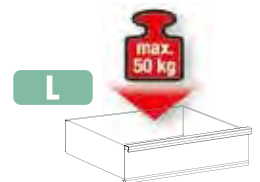

755 × 398 × 154 mm

825.8564

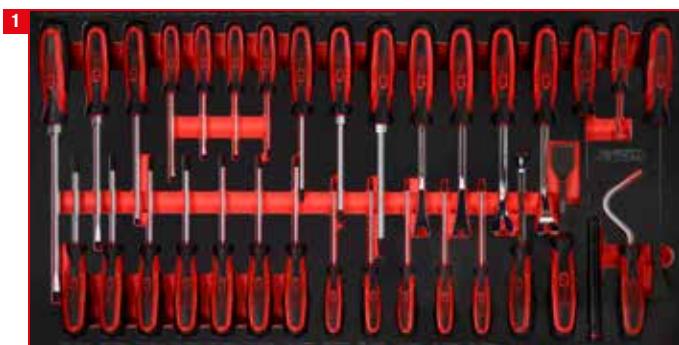

Odvijač-set

33



1/4" + 3/8" utični ključ-set

213



1/2" utični ključ-set

86



Set odvijača

57



Set odvijača

54

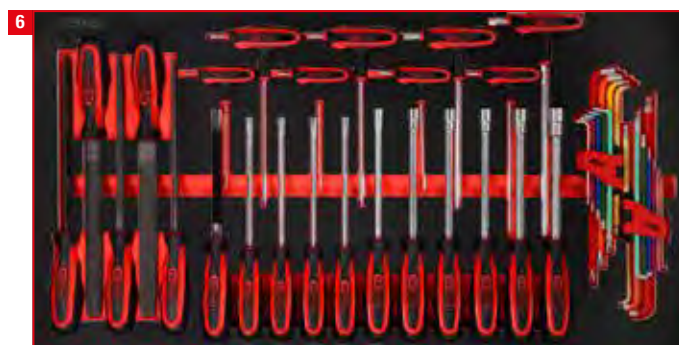

Set odvijača i turpija

42

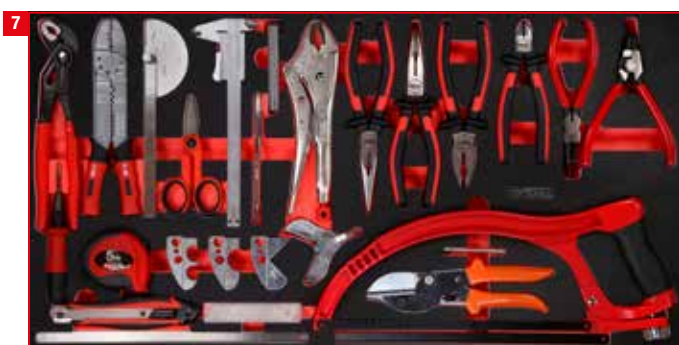

Set klešta i merača

39



Set čekića, dleta i Kraft nasadnih ključeva

40

KOLIKO AUTOMOBILA ŽELITE?



radna ploča sa penastom podlogom debljine 10 mm



može da se zaključa pomoću ugrađene cilindrične brave



sa samouvlačenjem i SOFT-CLOSE funkcijom



Kvadratne perforacije za delove pribora



2 x kočnice kotrljanja i okretanja
Ø točkova: 125 mm

ECO Line

59390,-

BEZ ALATA



Ostale informacije

Tehnički podaci:	Eco Line 897.0007	Racing Line 826.0007
Ukupna nosivost:	300,0 kg	350,0 kg
opteretivost po fioci:	25,0 kg	30,0 kg
samouvlačenjem i SOFT-CLOSE funkcijom:	✓	✗
prečnik točka:	125,0 mm	125,0 mm
Alat za fiksiranje točka:	✓	✓
Sa centralnim zaključavanjem:	✓	✓
pojedinačno zaključavanje:	✗	✓
Visina:	1014,0 mm	976,0 mm
Širina:	748 mm	788 mm
Dubina:	459,0 mm	496,0 mm
unutrašnje dimenzije fioke:	565 x 395 mm	565 x 395 mm
sa poliuretanskom zaštitom uglova i ivica:	✗	✓
Kvadratne perforacije za delove pribora:	✓	✓
Broj fioke:	7	7
debljina lima:	0,8 mm	0,9 mm
lajsne za hvatanje:	✓	✓
Izvlačenje fioke:	100 %	90 %
radna ploča sa policama za sitne delove:	✗	✓
Radna ploča sa ulošcima od pene:	✓	✗
vodice fioke na kugličnim ležajevima:	✓	✓
sa bočnom metalnom ručkom:	✓	✓

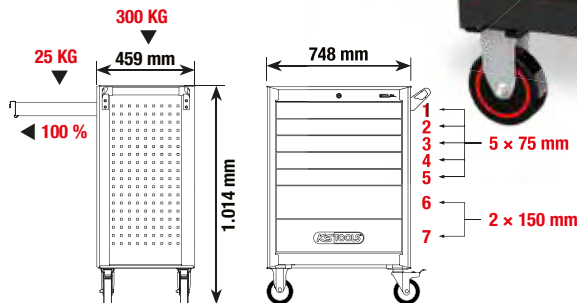

MUKE OKO IZBORA? IZBOR KVALITETA!

RACING Line



radna ploča od ABS-a sa pregradama za sitne delove



može da se zaključa pomoću ugrađene cilindrične brave



pojedinačno zaključavanje sprečava neželjeno otvaranje



Kvadratne perforacije za delove pribora



2 x kočnice kotrljanja i okretanja
Ø točkova: 125 mm

65990,-

BEZ ALATA



Ostale informacije

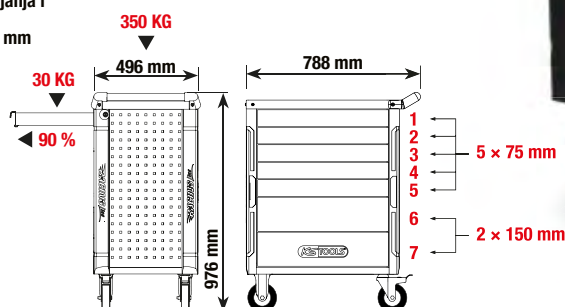

ECO *line*

Sa 7 fioka i 215 Premium alata

89750,-

897.7215



STARTNI PAKET - 215 DELOVA



Ostale informacije

RACING *line*

Sa 7 fioka i 215 Premium alata

92390,-

826.7215



ECO *line*

Sa 7 fioka i 515 Premium alata

116150,-

897.7515



UNIVERZALNI PAKET - 515 DELOVA

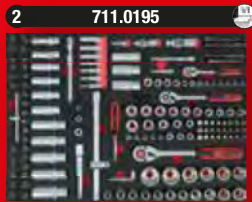
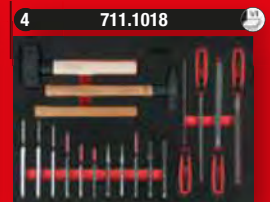
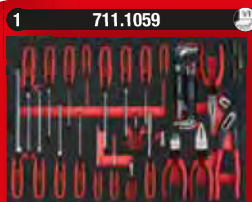

Ostale informacije

RACING *line*

Sa 7 fioka i 515 Premium alata

118790,-

826.7515



ECO *line*

Sa 7 fioka i 598 Premium alata

171470,-

897.7598



POWER PAKET - 598 DELOVA

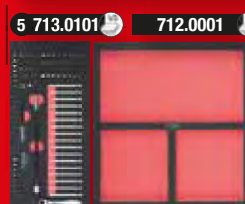
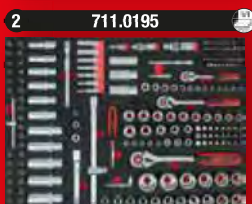
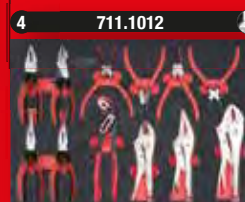
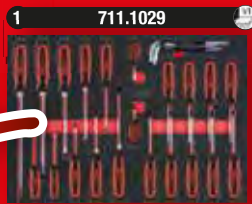

Ostale informacije

RACING *line*

Sa 7 fioka i 598 Premium alata

178070,-

826.7598



- DIN 3110 / ISO 1085 / ISO 10102 / ISO 3318
- pozicija čeljusti 15° povijena
- brušene glave
- mat satinirano
- hrom vanadijum

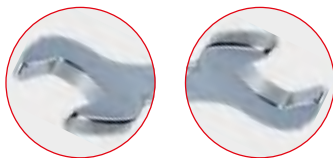

od 2630,-

A	517.0148			6x7 · 8x9 · 10x11 · 12x13 14x15 · 16x17 · 18x19 20x22 mm	2630,- RSD
B	517.0123			6x7 · 8x9 · 10x11 · 12x13 14x15 · 16x17 · 18x19 20x22 · 21x23 · 24x27 30x32 mm	5930,- RSD
C	517.0125			6x7 · 8x9 · 10x11 · 12x13 14x15 · 16x17 · 18x19 20x22 · 21x23 · 24x27 25x28 · 30x32 mm	6590,- RSD



- trakcioni profil
- pozicija čeljusti 15° povijena
- prsten 15° povijen
- polirane glave
- mat satinirano



od 3030,-

A	517.0048			8 · 9 · 10 · 11 · 13 · 14 17 · 19 mm	3030,- RSD
B	517.0052			8 · 9 · 10 · 11 · 12 · 13 · 14 15 · 16 · 17 · 18 · 19 mm	5670,- RSD
C	517.0043			6 · 7 · 8 · 9 · 10 · 11 · 12 13 · 14 · 15 · 16 · 17 · 18 19 · 20 · 21 · 22 · 24 · 27 30 · 32 mm	14460,- RSD



- 12-ivični
- DIN 838 / ISO 1085 / ISO 10104 / ISO 3318
- prstenovi 75° zglavkasti
- tanki zidovi
- polirane glave



od 3290,-

A	517.0248			6x7 · 8x9 · 10x11 · 12x13 14x15 · 16x17 · 18x19 20x22 mm	3290,- RSD
B	517.0222			6x7 · 8x9 · 10x11 · 12x13 14x15 · 16x17 · 18x19 20x22 · 21x23 · 24x27 30x32 mm	6590,- RSD



i **1**
Ostale informacije

1970,-

315 mm

19 mm 22 mm

522.1922

i **1**
Ostale informacije

REVERZIBILNI RAČNA 4 U 1

10 mm 13 mm 17 mm 19 mm

72° 5°

2630,-

503.4565 10 x 13 x 17 x 19 mm

i **1**
Ostale informacije

MULTITALENAT

Jednoručni multifunkcionalni ključ

260 mm

14-32 mm 8-17 mm

114.0055 8 · 9 · 10 · 11 · 12 · 13 · 14 · 15 · 16 · 17 · 18 · 19 · 20 · 21 · 22 · 23 · 24 · 25 · 26 · 27 · 28 · 29 · 30 · 31 · 32 mm

4480,-

i **12**
Ostale informacije

72° 5°

15830,-

503.4665 8 · 9 · 10 · 11 · 12 · 13 · 14 · 15 · 16 · 17 · 18 · 19 mm

i **30**
Ostale informacije

SVESTRANI

72° 5°

STOP

5/16" x 13 mm 1/2" 10 mm x 13 mm 3/8" 1/4" x 10 mm 1/4" 12 x 12 x

22300,-

503.4960 8 · 9 · 10 · 11 · 12 · 13 · 14 · 15 · 16 · 17 · 18 · 19 mm

i **2**
Ostale informacije

72° 5°

1/2" 305 - 445 mm

173 - 223 mm

1/4"

NOVO **4610,-**

PODESIVO:
1/4" U 4 STEPENA
1/2" U 6 STEPENOVA

914.1412

i **1**
Ostale informacije

NOVO **600 MM!**

72° 5°

1/2" 460 - 600 mm

stepen: 1 2 3 4 5 6

3290,-

PODESIVO U 6 STEPENI

914.1205

i **1**
Ostale informacije

6590,-

760 mm

**MAKSIMALNA FLEKSIBILNOST,
OPTIMALNA KONTROLA**

1/2"

918.1293

72° 5°

**POSTOJANA SNAGA -
INOVATIVNA FUNKCIJA**

A B C

1/4" 3/8" 1/2"

od 3290,-

			Nm		
A	920.1490		1/4"	102	140 mm 3290,- RSD
B	920.3890		3/8"	325	190 mm 3950,- RSD
C	920.1290		1/2"	710	245 mm 4820,- RSD

102 Nm

710 Nm

72° 5°

7250,-

920.0002 **i** **2**
Ostale informacije

NAJBOLJI KOJI SMO IMALI DO SADA!

Mi znamo šta možemo. I zato što tačno znamo koliko je dobar naš novi asortiman Monster račun, za nas se podrazumeva da vam obezbedimo garanciju za svaki model. Ne 2 ili 3 godine. Ne, odmah vam dajemo 10 godina! Na taj način je garancija podjednako Premium kao i naši Monster račun!



1 **80°** **4,5°**
1/4"

3950,- **i** **1**
Ostale informacije

935.1490 **1/4"** **106 g** **125 mm** **>110 Nm**



2 **80°** **4,5°**
1/4"

3950,- **i** **1**
Ostale informacije

935.1495 **1/4"** **106 g** **125 mm** **>100 Nm**

3 **96°** **3,75°**
3/8"

5270,- **i** **1**
Ostale informacije

935.3890 **3/8"** **227 g** **199 mm** **>365 Nm**



**GARANTOVANO:
6 MONSTER DO
KRAJA ŽIVOTA!**

4 **100°** **3,6°**
1/2"

6590,- **i** **1**
Ostale informacije

935.1290 **1/2"** **567 g** **275 mm** **>950 Nm**

5 **100°** **3,6°**
1/2"

9230,- **i** **1**
Ostale informacije

935.1295 **1/2"** **757 g** **425 mm** **>950 Nm**

6 **100°** **3,6°**
1/2"

13190,- **i** **1**
Ostale informacije

TELESKOPSKI

406 431 457 482 508 533 557 582 607 635 mm **>950 Nm**

935.1285 **1/2"** **1.280 g** **406 - 635 mm**

NOVO **-15%**

935.0002 **100°** **3,6°** **1/2"** **>950 Nm**

+ **80°** **4,5°** **1/4"** **>110 Nm**

9230,- **i** **2**
Ostale informacije



9

Set bit nasadnih ključeva za inbus zavrtnje, kratki

Ostale informacije

3/8"

4 mm 5 mm 6 mm 7 mm 8 mm 9 mm 10 mm 12 mm 14 mm



posebno kratka varijanta ✓

NOVO

4610,-

917.4000 4 - 5 - 6 - 7 - 8 - 9 - 10 - 12 - 14 mm

MOLIM JEDAN BIT! ALI KRATAKI!



10

Set bit nasadnih ključeva za Torx zavrtnje, kratki

Ostale informacije

3/8"

T10 T15 T20 T25 T27 T30 T40 T45 T50 T55

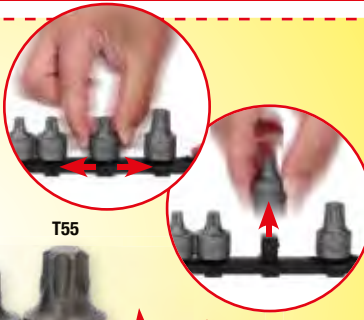

posebno kratka varijanta ✓

NOVO

5270,-

917.4015 T10 - T15 - T20 - T25 - T27 - T30 - T40 - T45 - T50 - T55

TORX TOTAL: SVE U JEDNOM KOFERU



77

Ostale informacije

5 x		1/4": E4 - E5 - E6 - E7 - E8
4 x		3/8": E10 - E12 - E14 - E16
4 x		1/2": E18 - E20 - E22 - E24
5 x		1/4": EPL4 - EPL5 - EPL6 - EPL7 - EPL8
4 x		3/8": EPL10 - EPL12 - EPL14 - EPL16
4 x		1/2": EPL18 - EPL20 - EPL22 - EPL24
8 x		1/4": T6 - T8 - T10 - T15 - T20 - T25 - T27 - T30
5 x		3/8": T40 - T45 - T47 - T50 - T55
2 x		1/2": T60 - T70
7 x		1/4": TB8 - TB10 - TB15 - TB20 - TB25 - TB27 - TB30
4 x		3/8": TB40 - TB45 - T50 - T55
1 x		1/2": TB60
7 x		1/4": IP8 - IP10 - IP15 - IP20 - IP25 - IP27 - IP30
3 x		3/8": IP40 - IP45 - IP50
2 x		1/2": IP55 - IP60
7 x		1/4": IPR8 - IPR10 - IPR15 - IPR20 - IPR25 - IPR27 - IPR30
3 x		3/8": IPR40 - IPR45 - IPR50
2 x		1/2": IPR55 - IPR60

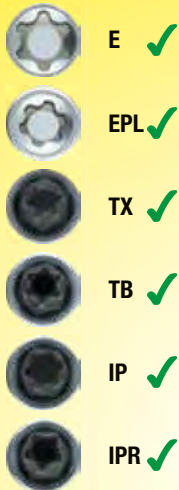

13190,-

NOVO



EVOLUTION SERIES

1/4" + 3/8" + 1/2"



i  **30**
Ostale informacije

EVOLUTION SERIES

NOVO

10550,-

STAINLESS STEEL

55 mm		5 - 6 - 7 - 8 - 10 - 12 - 14 - 17 - 19 mm
100 mm		5 - 6 - 7 - 8 - 10 - 11 - 12 - 13 mm
140 mm		5 - 6 - 7 - 8 - 10 - 12 - 14 mm
200 mm		5 - 6 - 7 - 8 - 10 - 12 mm

1/2" 

911.4510

i  **32**
Ostale informacije

EVOLUTION SERIES

NOVO

10550,-

STAINLESS STEEL

55 mm		M5 - M6 - M7 - M8 - M9 - M10 - M12 - M13 - M14
100 mm		M5 - M6 - M7 - M8 - M9 - M10 - M12 - M13 - M14
140 mm		M7 - M8 - M9 - M10 - M12 - M13 - M14
200 mm		M7 - M8 - M9 - M10 - M12 - M13 - M14

1/2" 

911.4520

i  **26**
Ostale informacije

EVOLUTION SERIES

NOVO

10550,-

STAINLESS STEEL

55 mm		M5 - M6 - M8 - M9 - M10 - M12 - M14 - M16
100 mm		M5 - M6 - M8 - M9 - M10 - M12 - M14
140 mm		M5 - M6 - M8 - M9 - M10 - M12 - M14
200 mm		M8 - M10 - M12 - M14

1/2" 

911.4540

i  **32**
Ostale informacije

EVOLUTION SERIES

NOVO

10550,-

STAINLESS STEEL

55 mm		T20 - T25 - T27 - T30 - T40 - T45 - T50 - T55 - T60 - T70
100 mm		T20 - T25 - T27 - T30 - T40 - T45 - T50 - T55 - T60 - T70
140 mm		T40 - T45 - T50 - T55 - T60 - T70
200 mm		T40 - T45 - T50 - T55 - T60 - T70

1/2" 

911.4550

A mat satiniran **B** hromirano, visokog sjaja

od 3690,-

mat satiniran hromirano, visokog sjaja

niklovano

A	917.0648		48	3690,- RSD	1/4"
B	918.0648		48	3950,- RSD	1/4"

4- 4,5 - 5 - 5,5 - 6 - 7 - 8 - 9
10 - 11 - 12 - 13 - 14 mm

20
Ostale informacije

7910,-

mat satiniran

1/2"

10 - 11 - 12 - 13 - 14 - 15
16 - 17 - 18 - 19 - 22 - 24
27 - 30 - 32 mm

911.0620

A mat satiniran **B** hromirano, visokog sjaja

od 10550,-

mat satiniran hromirano, visokog sjaja

niklovano

A	911.0694		94	10550,- RSD	1/4" + 1/2"
B	918.0694		94	11870,- RSD	1/4" + 1/2"

4- 4,5 - 5 - 5,5 - 6 - 7 - 8 - 9
10 - 11 - 12 - 13 - 14 - 15 - 16
17 - 18 - 19 - 20 - 21 - 22 - 23
24 - 27 - 30 - 32 mm

108
Ostale informacije

11870,-

mat satiniran

1/4" + 1/2"

4- 4,5 - 5 - 5,5 - 6 - 7 - 8 - 9
10 - 11 - 12 - 13 - 14 - 15 - 16
17 - 18 - 19 - 20 - 21 - 22 - 24
27 - 30 - 32 mm

911.0708

niklovano



Ostale informacije

1/4"	4 - 4,5 - 5 - 5,5 - 6 - 7 - 8 - 9 - 10 - 11 - 12 13 - 14 mm
1/4"	4 - 5 - 6 - 7 - 8 - 9 - 10 mm
	E4 - E5 - E6 - E7 - E8
	⊖ ⊕ ⊗ ⊙ ⊛ ⊜ ⊝
3/8"	10 - 11 - 12 - 13 - 14 - 15 - 16 - 17 - 18 19 mm
3/8"	10 - 11 - 12 - 13 - 14 - 15 mm
	E10 - E11 - E12 - E14 - E16 - E1
1/2"	10 - 11 - 12 - 13 - 14 - 15 - 16 - 17 - 18 19 - 20 - 21 - 22 - 24 - 27 - 30 - 32 mm
1/2"	16 - 17 - 18 - 19 - 22 mm
	E20 - E24
1/4" 5/16"	⊖ ⊕ ⊗ ⊙ ⊛ ⊜ ⊝
1/4" - 3/8" 1/2"	50 - 100 - 125 - 150 - 250 mm
	1,3 - 1,5 - 2 - 2,5 - 3 - 4 - 5 mm
1/4" - 3/8" 1/2"	
1/4" - 3/8" 1/2"	1/4" - 5/16"
1/4"	

1/4" + 3/8" + 1/2"

niklovano

mat satinirano

917.0779 ⊕ ⊗ ⊙ ⊛ ⊜ ⊝



12530,-

1/4"	4 - 4,5 - 5 - 5,5 - 6 - 7 - 8 - 9 - 10 - 11 12 - 13 - 14 mm
1/4"	6 - 7 - 8 - 9 - 10 - 11 - 12 - 13 - 14 15 mm
	⊖ ⊕ ⊗ ⊙ ⊛ ⊜ ⊝
3/8"	10 - 11 - 12 - 13 - 14 - 15 - 16 - 17 - 18 19 mm
3/8"	10 - 11 - 12 - 13 - 14 - 15 mm
1/2"	10 - 11 - 12 - 13 - 14 - 15 - 17 - 18 - 19 20 - 21 - 22 - 24 - 27 - 30 - 32 mm
1/2"	17 - 19 - 22 mm
	⊛
1/4" 5/16"	⊖ ⊕ ⊗ ⊙ ⊛ ⊜ ⊝
12 x	8 - 9 - 10 - 11 - 12 - 13 - 14 - 15 - 16 17 - 18 - 19 mm
	1,3 - 1,5 - 2 - 2,5 - 3 - 4 - 5 mm
1/4" - 3/8" 1/2"	
1/4"	



A mat satiniran



B hromirano, visokog sjaja



od

23090,-

A 917.0216



216

23090,- RSD

niklovano

B 918.0216



216

25070,- RSD

1/4" + 3/8" + 1/2"



A	911.0721			21		19 · 21 · 22 · 23 · 24 · 26 · 27 · 29 · 30 32 · 35 · 36 · 38 · 41 · 46 · 50 mm	29030,- RSD
B	911.0722			21		19 · 21 · 22 · 23 · 24 · 26 · 27 · 29 · 30 32 · 35 · 36 · 38 · 41 · 46 · 50 mm	32810,- RSD
C	911.0751			21		3/4" · 13/16" · 7/8" · 15/16" · 1" 1.1/16" · 1.1/8" · 1.3/16" · 1.1/4" 1.5/16 · 1.3/8" · 1.7/16" · 1.1/2" 1.5/8" · 1.3/4" · 2"	32810,- RSD

od
29030,-

			82
Ostale informacije			
1/4"			4 - 4,5 - 5 - 5,5 - 6 - 7 - 8 - 9 - 10 - 11 12 - 13 - 14 mm
1/2"			14 - 15 - 16 - 17 - 18 - 19 - 20 - 21 - 22 24 - 27 - 30 - 32 mm
1/4"			16 - 21 mm
1/4"			
5/16"			
1/4"			
1/2"			
1/4"			150 mm
1/4"			50 - 100 - 125 - 250 mm
1/2"			
1/4"			150 mm
12 x			8 - 10 - 11 - 12 - 13 - 14 - 17 - 19 - 22 mm



17150,-

911.0682

1/4" + 1/2"

i  **47**
Ostale informacije



1/2"		10 - 11 - 12 - 13 - 14 - 15 - 16 - 17 18 - 19 - 20 - 21 - 22 - 24 mm
3 x		16 - 18 - 21 mm
14 x		6 - 7 - 8 - 9 - 10 - 11 - 12 - 13 - 14 15 - 16 - 17 - 18 - 19 mm
1 x		250 mm
2 x		125 - 250 mm
1 x		1/2"
5 x		3 - 5,5 - 8 mm PH1 - PH2
1 x		T8 - T10 - T15 - T20 - T25 - T27 T30 - T40
1 x		2,5 - 3 - 4 - 5 - 6 - 7 - 8 - 10 mm
1 x		3 - 48 V
1 x		240 mm
1 x		180 mm
1 x		300 g













19790,-

mat satinirano

1/2"

940.0047



1/4"		4 - 4,5 - 5 - 5,5 - 6 - 7 - 8 - 9 - 10 11 - 12 - 13 mm
1/2"		10 - 11 - 12 - 13 - 14 - 15 - 16 - 17 19 - 20 - 21 - 22 - 24 - 27 - 30 - 32 mm
12 x		8 - 9 - 10 - 11 - 12 - 13 - 14 - 15 - 16 17 - 18 - 19 mm
2 x		1/4": 100 mm / 1/2": 125 mm
1 x		1/4" / 1/2"
7 x		3 - 4 - 5,5 - 6,5 mm PH0 - PH1 - PH2
1 x		T8 - T10 - T15 - T20 - T25 - T27 - T30 T40 - T45 - T50
1 x		1,5 - 2 - 2,5 - 3 - 4 - 5 - 6 - 8 - 10 mm
1 x		300 g
1 x		160 mm
1 x		200 mm



1/4" + 1/2"

A mat satiniran

B hromirano, visokog sjaja

A 917.0797



23090,- RSD

B 918.0797



25070,- RSD

niklovano



od
23090,-

i **88**
Ostale informacije

150-250 V

1/4"		4 - 4,5 - 5 - 5,5 - 6 - 7 - 8 - 9 - 10 - 11 12 - 13 mm
1/2"		14 - 15 - 16 - 17 - 18 - 19 - 20 - 21 - 22 23 - 24 - 25 - 26 - 27 - 28 30 - 32 mm
12 x		6 - 7 - 8 - 9 - 10 - 11 - 12 - 13 - 14 17 - 19 - 22 mm
3 x		1/4": 50 - 100 mm / 1/2": 125 mm
1 x		1/4"
4 x		6,5 - 8 mm + PH1 - PH2
1 x		1/4"
1 x		1/4"
1 x		150 - 250 V
1 x		250 mm
1 x		180 mm
1 x		300 g

5°

R

L

25070,-

mat
satinirano

911.0688

1/4"
+ 1/2"

i **127**
Ostale informacije

SVESTRANI

1

4 x

2

8 x 8 - 9 - 10 - 11 - 13
14 - 17 - 19 mm

3

4

48830,-

911.0727

1/4"
+ 1/2"

400 mm

490 mm



Ostale informacije



6 x



1/4" 4 - 4,5 - 5 - 5,5 - 6 - 7
8 - 9 - 10 - 11 - 12
13 mm

1/2" 10 - 13 - 14 - 15 - 16
17 - 18 - 19 - 21 - 22
24 - 27 - 30 - 32 mm

10 x 8 - 10 - 11 - 12 - 13
14 - 15 - 17 - 19 - 22 mm



51470,-

911.0649

1/4" + 1/2"

PUNA OPREMA? U TOM SE SLUČAJU POSLUŽITE OVDE!



Ostale informacije



6 x

3 x



9 x 1,5 - 2 - 2,5 - 3 - 4 - 5 - 6
8 - 10 mm

9 x TS10 - TS15 - TS20 - TS25
TS27 - TS30 - TS40 - TS45
TS50



1/4" 4 - 4,5 - 5 - 5,5 - 6 - 7
8 - 9 - 10 - 11 - 12
13 mm

1/2" 10 - 11 - 12 - 13 - 14
15 - 16 - 17 - 18 - 19
21 - 22 - 24 - 27 - 30
32 mm

11 x 8 - 9 - 10 - 11 - 12
13 - 14 - 16 - 17 - 19
22 mm



59390,-

911.0630

1/4" + 1/2"



Ostale informacije

ZA ELEKTRIČARE 1

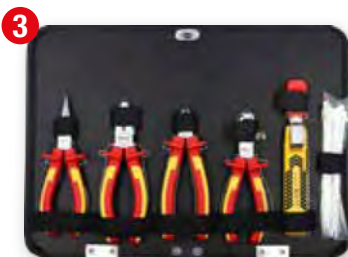

4 x

1/4" 4 - 4,5 - 5 - 5,5 - 6 - 7 - 8
9 - 10 - 11 - 12 - 13 mm

1/2" 10 - 11 - 12 - 13 - 14 - 15
16 - 17 - 18 - 19 - 21 - 22 mm

10 x 8 - 10 - 11 - 12 - 13 - 14
15 - 17 - 19 - 22 mm

911.0628

1/4" + 1/2"

51470,-



Ostale informacije

ZA SVE PRIMENE

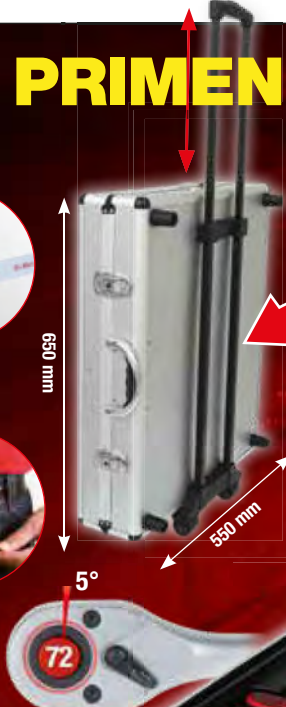

1/4" 4 - 5 - 6 - 7 - 8 - 9 - 11
12 - 13 mm

1/2" 10 - 11 - 12 - 13 - 14 - 15 - 16
17 - 18 - 19 - 21 - 22 - 24 mm

10 x 8 - 9 - 10 - 11 - 12 - 13
14 - 16 - 17 - 18 - 19 mm

911.0735

1/4" + 1/2"

68630,-



99



Ostale informacije

KOVČEG S BLAGOM!



99



Ostale informacije



1/4"	4 - 5 - 6 - 7 - 8 - 9 - 10 - 11 - 12 13 - 14 mm
1/2"	13 - 15 - 17 - 18 - 19 - 20 - 21 - 22 24 - 27 - 30 - 32 mm

**USTAVLJAJČKI OKASTI-VILJUŠKASTI KLJUČ****IZBOR JE NA VAMA!****OKASTI-VILJUŠKASTI KLJUČ**

8 - 9 - 10 - 11 - 12 - 13 - 14 - 15 - 16 - 17 - 18 - 19 mm

8 - 9 - 10 - 11 - 12 - 13 - 14 - 15 - 16 - 17 - 18 - 19 mm

**79190,-**

1/4" 1/2"

**68630,-**

1/4" 1/2"

918.0100



918.0200



40



Ostale informacije



1/2"

9 - 10 - 11 - 12 - 13 - 14 - 15 - 16 - 17 - 18
19 - 20 - 21 - 22 - 23 - 24 - 26 - 27 - 30 mm9 - 10 - 11 - 12 - 13 - 14 - 15 - 16 - 17 - 18
19 - 20 - 21 - 22 - 23 - 24 - 26 - 27 - 30 mm**15170,-**

1/2"

515.0065





Ostale informacije







od
13190,-

Top proizvodni put
SERTIFIKOVANOSTI OBLASTI
DIN EN ISO 9109
Potvrda
Preciznost
±0,5%

Skala sa lupom



Skala u mikrometrima



		Nm	Podela Nm	Lbf-ft		
516.1402		1/4"	1-5	0,10	0,8 - 3,6	13190,- RSD
516.1412		1/4"	5-25	0,10	0,8 - 18	13190,- RSD
516.1422		3/8"	10-50	0,25	4 - 37	13190,- RSD
516.1432		1/2"	20-100	0,50	8 - 75	14640,- RSD
516.1442		1/2"	40-200	1,00	15 - 150	14640,- RSD
516.1472		1/2"	60-320	1,00	45 - 236	16490,- RSD
516.1482		1/2"	80-420	1,00	60 - 310	17940,- RSD
516.1493		3/4"	150-750	10,00	150 - 550	77740,- RSD
516.1495		1"	200-1000	20,00	220 - 730	88960,- RSD





Ostale informacije

3 U 1



1310,-

A	151.2100		8		2 - 2,5 - 3 - 4 - 5 - 6 8 - 10 mm	1310,- RSD
B	151.2300		8		T10 - T15 - T20 - T25 T30 - T40 - T45 - T50	1310,- RSD





Ostale informacije

22



1710,-

A	151.2100		8		2 - 2,5 - 3 - 4 - 5 - 6 8 - 10 mm	1310,- RSD
B	151.2300		8		T10 - T15 - T20 - T25 T30 - T40 - T45 - T50	1310,- RSD

22 NAJVAŽNIJIH
U JEDNOM SETU

32
Ostale informacije



niklovano

1 x		1/4"
1 x		1/4"
3 x		PH1 - PH2 - PH3
6 x		2 x PZ1 - 2 x PZ2 - 2 x PZ3
3 x		5,5 - 6,5 - 8 mm
3 x		4 - 5 - 6 mm
15 x		2 x TB10 - 3 x TB15 - 2 x TB20 3 x TB25 - 3 x TB30 - 2 x TB40

911.2060



25 mm



50 mm

32
Ostale informacije

TORION power

+30%

1 x		1/4"
1 x		1/4"
4 x		3 - 4 - 5 - 6 mm
4 x		PH1 - 2 x PH2 - PH3
4 x		PZ1 - 2 x PZ2 - PZ3
4 x		3 - 4 - 5 - 6 mm
7 x		T10 - T15 - T20 - T25 - T27 - T30 - T40
7 x		TB10 - TB15 - TB20 - TB25 - TB27 - TB30 - TB40

911.3030

1180,- 1310,-

108
Ostale informacije

TORION power

3950,-

NOVO



+30%

6x		4 - 5 - 6 mm
6x		4 - 5 - 6 mm
6x		PH1 - PH2 - PH3
6x		PZ1 - PZ2 - PZ3
6x		T10 - T15 - T20 - T25 - T30 - T40

108 BITOVA KOJI ČINE RAZLIKU

918.3108 1/4"

32
Ostale informacije



68 mm

100 mm



-22,1%

-49%

4 x		3 - 4 - 5 - 6 mm
4 x		PH1 - 2 x PH2 - PH3
4 x		PZ1 - 2 x PZ2 - PZ3
4 x		3 - 4 - 5 - 6 mm
7 x		T10 - T15 - T20 - T25 T27 - T30 - T40
7 x		TB10 - TB15 - TB20 - TB25 TB27 - TB30 - TB40

5930,-

918.3010 1/4"

31
Ostale informacije

TORION power



2 x		4 - 5 mm
3 x		PH1 - PH2 - PH3
3 x		PZ1 - PZ2 - PZ3
9 x		1,5 - 2 - 2,5 - 3 - 4 - 5 - 6 7 - 8 mm
11 x		T6 - T7 - T8 - T9 - T10 - T15 T20 - T25 - T27 - T30 - T40

7650,-

918.3015 1/4"

i **24**
Ostale informacije

MALI & FINI



25 mm
niklovano

2630,-

1 x		1/4": 92 mm
1 x		1/4": 50 mm
1 x		1/4"
6 x		6 - 7 - 8 - 10 - 11 - 13 mm
2 x		PH1 - PH2
2 x		PZ1 - PZ2
2 x		4,5 - 5,5 mm
4 x		3 - 4 - 5 - 6 mm
5 x		TB10 - TB15 - TB20 - TB25 - TB30

911.2010 **1/4"**

i **208**
Ostale informacije

5270,-

ODVIJAČ ZA SVE!



1/4"		1/4": 205 mm
138 x		25 mm
29 x		50 mm
18 x		75 mm
20 x		4 - 5 - 6 - 7 - 8 - 9 - 10 - 11 - 12 - 13 mm 5/32" - 3/16" - 7/32" - 1/4" - 9/32" 5/16" - 11/32" - 3/8" - 7/16" - 1/2"
1 x		1/4": 50 mm
1 x		1/4"

911.2008 **1/4"**

i **7**
Ostale informacije

MALO ČUDO TEHNIKE!

1310,-

6 IN ONE



110 mm

NOVO

- 4 - 5 mm
- PH1 - PH2
- PZ1 - PZ2

911.2025 **1/4"**

6 u 1 Mini ustavljački odvijač

i **13**
Ostale informacije

1970,-

12 IN ONE



240 mm

- 4 - 5 - 6 mm
- PH1 - PH2 - PH3
- 3 - 4 - 5 mm
- T15 - T20 - T25

911.2035 **1/4"**

12 u 1 račna odvijači za bitove

1
Ostale informacije

2 U 1

1/4"

ILI

85 mm

1180,-

514.1126

1
Ostale informacije

1/4"

1440,-

SA ZGLOBOM

90 mm

20°

514.1136

21
Ostale informacije

30 mm

165 mm

4 mm

Ø 16 mm

1 - 1,3 - 1,5 - 2 - 2,5 - 3 mm

PH00 - PH0 - PH1 - PH2

1,5 - 2 - 2,5 - 3 - 3,5 mm

T3 - T4 - T5 - T6 - T7

5270,-

500.7195

27
Ostale informacije

LED

1/4"

eMONSTER

JEDNOM DODIRNUT, ZAUVEK ZAVEDEN.

4610,-

515.3600

4x		3,0 - 4,0 - 5,0 - 6,0 mm
4x		3,0 - 4,0 - 5,0 - 6,0 mm
5x		PH0 - PH1 - PH2 - PH3
4x		PZ0 - PZ1 - PZ2 - PZ3
4x		T10 - T15 - T20 - T25
4x		#0 - #1 - #2 - #3
1x		PH1
1x		50 mm
1x		Max. 6 Nm

max 6 Nm

max 4 Nm

max 2 Nm

USB-C

3,6 V

1.500 mAh

300 rpm

USB-C

2+ LED



51



Ostale informacije

ZA SVE PRIMENE



1 bušenje



2 čišćenje



3 brušenje



23x



4 graviranje

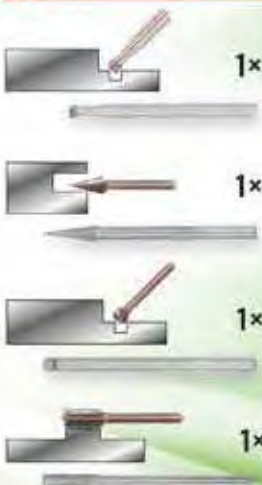

5 razdvajanje



6 poliranje



eMONSTER Set aku multifunkcionalnih alata sa 50 delova pribora



eMONSTER



6590,-

515.3990



50



Ostale informacije

ZA PONOVRNU KUPOVINU



Set pribora, 50-delni

1310,-

515.3992

TRANSFORMER MEĐU ODVIJAČIMA



eMONSTER

visokih
210 obrtaja u
minutu i time
5 x brže od ručnog
postupka
zatezanja

praktični indikator
napunjenosti baterije s
3 LED lampice

pojačan
prenosnik

magnetni prihvat
za bitove

1/4"

predizbor obrtnog
momenta podesev u
10 stepena

poboljšana udobnost
zahvatanja

1,3 Ah
akumulatorska
baterija koja traje za
1000+
zavrtnja

Li-ION veoma efikasna
akumulatorska baterija
se, zahvaljujući USB-C
priključku, brzo puni
i spremna je za rad.

Preterano zatezanje zavrtnja
sprečava se automatskim
zaključavanjem motora kada
se obrtni moment prekorači.

integrisana lampa



Ostale informacije

sa 25
bitova



1/4" (max.)

5270,-

515.6500

ERGOTORQUE^{plus}



hromiran i ojačan vrh



sa oznakom profila na drški

i **5** **159.0005**

Ostale informacije

1310,-

PH1 PH2 6,5 mm 5,5 mm 4 mm

i **6** **159.0030**

Ostale informacije

2630,-

T10 T15 T20 T25 T30 T40

i **6** **159.0040**

Ostale informacije

2630,-

TB10 TB15 TB20 TB25 TB30 TB40

i **39**

Ostale informacije

6720,-

6 x		3 - 4 - 5,5 - 6,5 - 8 - 10 mm	7 x		2 - 2,5 - 3 - 4 - 5 6 - 8 mm
5 x		PH0 - PH1 - PH2 PH3 - PH4	7 x		TB10 - TB15 - TB20 TB25 - TB27 - TB30 TB40
4 x		P20 - PZ1 - PZ2 PZ3	7 x		T10 - T15 - T20 T25 - T27 - T30 T40
1 x		6 mm	1 x		1/4"
1 x		PH2	1 x		205 mm

159.0100 **1/4"**

i **13**

Ostale informacije

TAJ MOŽE DA ISTRPI UDARCE!

8970,-

sečivo celom dužinom

5 x		3,5 - 5,5 - 7 - 8 - 10 mm
5 x		PH0 - PH1 - PH2 - PH3 - PH4
1 x		6 mm
1 x		PH2
1 x		1/4"

151.1150 **1/4"**

i  **15**
Ostale informacije

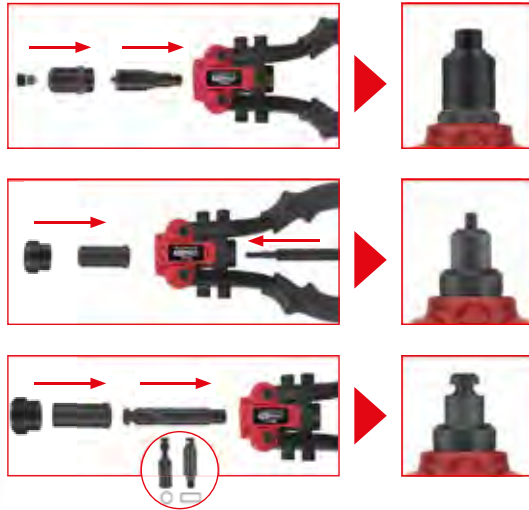

8970,-





















150.9805

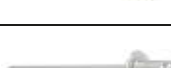

Zakivka (aluminijum)

Zakivka (čelik)

Navrtka

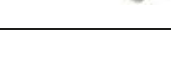
		A	B
		150.9805	150.9630
	u koferu	✓	✓
	dužina mm	260	510
	grickalica za lim	✓	✗
	operacija jednom ili dve ruke		
	M10	✓	✓
	M8	✓	✓
	M6	✓	✓
	M5	✓	✓
	M4	✓	✓
	M3	✓	✓
	Čelika 4,8 mm	✓	✓
	Čelika 4,0 mm	✓	✓
	Čelika 3,2 mm	✓	✓
	Čelika 2,4 mm	✓	✓
	Aluminijuma 6,4 mm	✓	✓
	Aluminijuma 4,8 mm	✓	✓
	Aluminijuma 4,0 mm	✓	✓
	Aluminijuma 3,2 mm	✓	✓
	Aluminijuma 2,4 mm	✓	✓

i  **17**
Ostale informacije

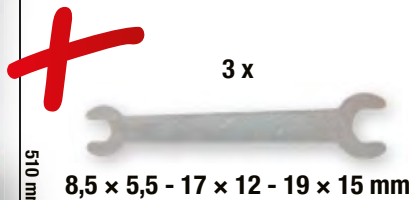

23090,-

150.9630

i  **1**
Ostale informacije



od 1440,-

	↔	↔	
115.2011	175 mm	7"	1440,- RSD
115.2010	240 mm	10"	1710,- RSD
115.2012	300 mm	12"	2100,- RSD
115.2016	415 mm	16"	4220,- RSD

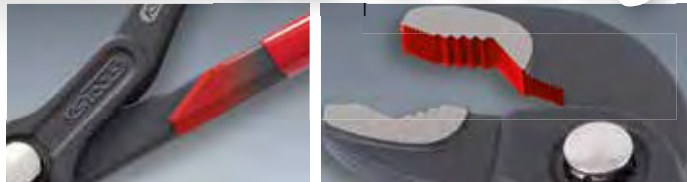

i  **4**
Ostale informacije

CrV DIN 5254 A DIN 5254 B DIN 5256 C DIN 5256 D

PREMIUM KVALITET!

i  **4**
Ostale informacije



A 19 - 60 mm



90°



0°



90°



B 40 - 100 mm

od 14640,-

	↔	↔	
A 119.2055	19 - 60 mm	160 mm	14640,- RSD
B 119.2060	40 - 100 mm	230 mm	16490,- RSD

i  **20**
Ostale informacije

SIGURNOST NA PRVOM MESTU



60 - 100 mm

40 - 85 mm

6590,-

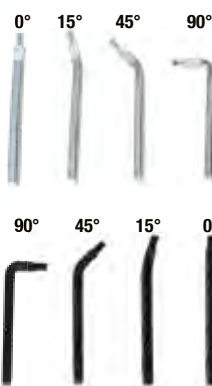

500.1350 Sigurnosna klešta-set sa ustavljačkom funkcijom

ODLIČNI PRECIZNI ALATI!

i **10**
Ostale informacije



1 x		120 mm	1 x		160 mm
1 x		120 mm	3 x		PH00 - PH0 - PH1
1 x		120 mm	3 x		2,0 - 2,4 - 3,0 mm

500.7220



i **21**
Ostale informacije



2 x		125 - 130 mm	3 x		PH00 - PH0 - PH1
1 x		100 mm	4 x		1,4 - 2,0 - 2,4 - 3,0 mm
1 x		100 mm	7 x		T6 - T7 - T8 - T9 T10 - T15 - T20
1 x		125 mm			
1 x		150 mm			
1 x		145 mm			

500.7190

i **1**
Ostale informacije

sa stabilnim podešivim vrhom sličnom rajsnadli

500.1001

780,-

2u1 teleskopski magnetni držač sa alatom za čišćenje i podešavanje mlaznica za pranje

150 - 675 mm

Ø 8,0 mm

sa krutom magnetnom glavom

i **1**
Ostale informacije

500.1136

1310,-

Fleksibilno kontrolno ogledalo sa osvetljenjem

260 - 760 mm

max. 60 h

1 x CR 2032

LED

i **1**
Ostale informacije

2,5 kg

500.1023

1050,-

2u1 teleskopski magnetni držač sa alatom za čišćenje i podešavanje mlaznica za pranje

150 - 590 mm

Ø 11,0 mm

sa fleksibilnom magnetnom glavom

s tankom šipkom za čišćenje

i **5**
Ostale informacije

500.1145

1970,-

5 U 1

NOVO

sa brzim zaključavanjem

3 x LR44

Ø 52,0 mm

Ø 31,0 mm

90,0 x 50,0 mm

172 - 640 mm

i **4**
Ostale informacije

1310,-

45° 135° 0° 90°

550.1045

i **9**
Ostale informacije

2630,-

45° 135° 0° 90° 45° 90° 0°

550.1070

i **1**
Ostale informacije

Piezo

115 mm

1180,-

960.1110

i **1**
Ostale informacije

300 mm

2630,-

550.1060

i **8**
Ostale informacije

95 mm

Ø 40 mm

49 mm

5 mm

Ø 1,6 mm

Ø 3,5 mm

Ø 4,5 mm

2630,-

960.1265

i **11**
Ostale informacije

Piezo

200 mm

20 mm

33 mm

Ø 1,6 mm

Ø 3,5 mm

Ø 4,5 mm

Ø 5 mm

30 mm

95 mm

95 mm

Ø 40 mm

ISO BUTAN

3950,-

960.1160 Mikro lemljenje-set

i **283**
Ostale informacije

22430,-

Ø 0,5 - 6 mm Ø 0,5 - 6 mm
Ø 0,5 - 10 mm Ø 6,50 / 5,41 / 1,72 mm Ø 0,5 - 4 mm

115.1400 Ø 1,0 - 3,2 mm

220 mm

i **1**
Ostale informacije

520,-

143 mm

118.0013

i **1**
Ostale informacije

od 390,-

	300.0113	300.0114	300.0115	300.0116
A	3 m	5 m	5 m	8 m
	16 mm	19 mm	25 mm	25 mm
	390,- RSD	520,- RSD	650,- RSD	780,- RSD

EG II

3 m 5 m 5 m 8 m

A 16 mm B 19 mm C 25 mm D 25 mm

i **5**
Ostale informacije

3950,-

960.1190

regulacija temperature:
1≈50°C / 2≈100°C / 3≈200°C /
4≈350°C / 5≈550°C / 6≈650°C

260 mm

1 2 3 4 5 6

1 max. 450°C
2 max. 650°C

Oblasti primene: skidanje boje, skupljanje PVCa, zavarivanje i savijanje plastike, sušenja, otapanja itd.

i **1**
Ostale informacije

17810,-

150.4217

IP 34

15+1 m

3x 1,5 mm²

230 V 50 Hz

1000/3000 W

10 A

180°

i **12**
Ostale informacije

1310,-

140.3050

145 mm

5,0 x 1,0 mm
5,0 x 1,0 mm
3,0 mm
3,0 mm
5,0 mm
5,0 mm
3,0 mm
2,0 mm
2,0 mm
5,0 mm
5,0 mm
5,0 mm

Heb 2

i **5**
Ostale informacije

3950,-

140.3000

200 mm

Heb 2

i **1**

Ostale informacije

2630,-

69 mm

138 mm

138 x 69 x 31 mm

342

9 V

Data Hold

150.1495

i **1**

Ostale informacije

3 - 48 V

140 mm

1580,-

Ispitivač polariteta i napona 3 - 48 V

550.1503

i **1**

Ostale informacije

125 mm

6 - 24 V

650,-

Ispitna lampa 6 - 24 V

550.1504

i **1**

Ostale informacije

AUTOMATIC
DIGITAL MULTIMETER

143 x 70 x 16 mm

119

AAA

Data Hold

16 mm

143 mm

70 mm

6590,-

NCV

USB-A

USB-C

150.1765

1 Dugme za uključivanje
2 Funkcijski prekidač
3 Kapacitivni prekidač
4 Prekidač za osvetljenje
5 LCD displej
6 Područje NCV senzora
7 Test kablovi

Simbol	Opis
	DC napon
	AC napon
	Indikator automatskog isključivanja
	Indikator niske baterije
	Diodni režim
	Prolaz
	Kapacitet
	Odnos merača snage
HOLD	Funkcija zadržavanja podataka
V, mV	Jedinica napona: volt, milivolt
mF, μF, nF	Jedinica kapaciteta
MΩ, KΩ, Ω	Jedinica otpora
NCV	Beskontaktna indukcija napona
Live	Testiranje živih linija
KHz, Hz	Jedinica frekvencije
°C/°F	Celzijus/Fahrenheit

3 COLOUR ANALOG BAR

BUZZER ALARM

i **3**
Ostale informacije

210 x 88 x 44 mm
655
9 V
Data Hold

4610,-

27,0 mm

maksimalno merljiv prečnik provodnika 29,0 mm

150.0925

i **1**
Ostale informacije

za istosmernu i naizmeničnu struju

AC	6 - 50 - 120 - 230 - 400 V
DC	6 - 50 - 120 - 230 - 400 V

3160,-

550.1501

UNIVERZALNI KLJUČ ZA RAZVODNI ORMAR

i **1**
Ostale informacije

MINI

42 mm

- 6 - 7 - 8 mm
- 9 mm
- 3 - 5 mm
- PH 2
- 7 mm

2240,-

130.1010

i **1**
Ostale informacije

71 mm

- 6 - 7 - 8 mm
- 9 mm
- 3 - 5 mm
- PH 2
- 7 mm

2370,-

130.1015

i **1**
Ostale informacije

61 mm

- 5 - 7 - 8 mm
- 9 - 10 mm
- 4 - 10 mm
- PH 2
- 7 mm

2370,-

130.1020

Žica za uvlačenje kabla

10 metara 20 metara

od 650,-

A	150.0960		1	Ø 3,0 mm 10 m	650,- RSD
B	150.0970		1	Ø 4,0 mm 20 m	1310,- RSD

i **1**
Ostale informacije

4610,-

Ø 3,0 mm

30 metara

Pomoćni alat za uvlačenje kablova

115.1113

i  **1**
Ostale informacije

3030,-



- sa utvrđivanjem momenta
- merne šine u mm i colnim podeocima
- s tabelom navoja

300.0510

i  **1**
Ostale informacije

3290,-



+/- 0.03 mm

- sa fiksirnim zavrtnjem i finim podešavanjem valjaka
- za spoljna, unutrašnja, postepena i dubinska merenja

300.0532

i  **1**
Ostale informacije

INFRACRVENI TERMOMETAR, -38° DO 520°



6590,-



150.3040

i  **4**
Ostale informacije

7520,-



Refraktometar - optički ispitni uređaj za tečnosti baterija u sredstvo protiv smrzavanja

550.1290

i  **4**
Ostale informacije

8970,-



Refraktometar - optički kontrolni uređaj za tečnost u akumulatoru, sredstvo za zaštitu od mraza i AdBlue® aditivi

550.1285

i  **4**
Ostale informacije

2630,-

11 x 115 mm
15 x 185 mm
18 x 320 mm
18 x 470 mm

911.8100 Metalna poluga-set

i  **4**
Ostale informacije

XL

900 mm
600 mm

0°
45°
75°
90°

23750,-

911.8410 Set metalnih poluga

i  **22**
Ostale informacije

Hidraulički univerzalni set skidača 2+3-kraki

- neznatna opasnost od isklizavanja usled automatskog zatvaranja kraka za skidanje
- moguće 8 varijanti skidanja
- ekstremno izdržljivo vreteno sa induktivno ojačanim navojem
- potrebna neznatna snaga
- specijalan čelik za alate

40250,-

700.1200

20 - 35 - 85 mm
235 mm
185 mm
10 t, AG 1.1/2" x 16G
225 mm
170 mm
120 mm
Ø max. 100 mm

i  **13**
Ostale informacije

NOVO ZA HITNE SLUČAJEVE

10550,-

0% ✓ 85% ✓

za odvijanje i vađenje zapekljih navrtki i zavrtnja sa oštećenim ili do 85% „oblaznutim“ glavama

11870,-

prstenovi 45° zglavkasti

Uključujući 3/8" 1/2"

913.3930 8 - 9 - 10 11 - 12 - 13 - 14 - 15 - 16 - 17 - 18 - 19 mm **3/8"**

517.1555 6x7 - 8x9 - 10x11 - 12x13 - 14x15 - 16x17 - 18x19 mm

JA SAM ZAVRTANJ, IZVADITE ME ODAVDE!

i  **6**
 Ostale informacije

2240,-

- za zavrtnje M3 - M18
- omogućava odvrtanje pokidanih zavrtnja i tipli
- konusna spirala
- u stabilnom plastičnom boksu

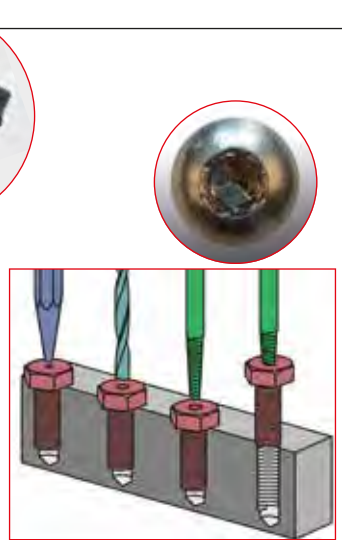





150.1330 Odvijač za zavrtnje-set

i  **34**
 Ostale informacije

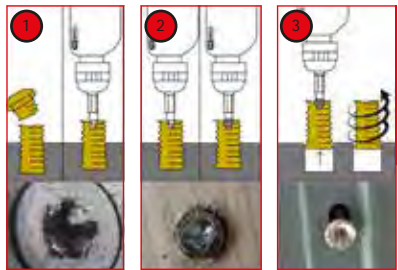
TORION power

5930,-



9 x		TE10 - TE15 - TE20 - TE25 - TE27 - TE30 - TE40 - TE50 - TE55
9 x		1,5 - 2 - 2,5 - 3 - 4 - 5 - 6 - 8 - 10 mm
7 x		1,5 - 2 - 2,5 - 3 - 4 - 5 - 6 mm
7 x		T10 - T15 - T20 - T25 - T27 - T30 - T40

150.7060  1/4" + 10 mm Set odvijača za torx i šestougla zavrtnje

i  **25**
 Ostale informacije

Odvijač navoja-set

- obiman sastav seta
- za uklanjanje slomljenih navojnih tipli i zavrtnja
- bez oštećenja navoja
- samo nezatno proširenje navojnih tipli preko specijalno profilisanih klinova za odvrtanje



Führungshülse drill guide	Hülse Innen- Ø mm guide	vorböhren Ø mm pre-drilling	aufbohren re-drilling	Stift pin	Art.Nr. Stift No. Pin	Mutter D nut D	Art.Nr. Mutter nut D	Stift + Mutter pin + nut
150.0501	4,0 / 3,2	3,2	-	3,2	150.0521	SW 10	150.0511	150.0511S
150.0502	4,8 / 3,2	3,2	-	3,2	150.0521	SW 10	150.0511	150.0511S
150.0503	4,8 / 3,2	3,2	4,8	4,8	150.0522	SW 11	150.0512	150.0512S
150.0504	4,8 / 3,2	3,2	4,8	4,8	150.0522	SW 11	150.0512	150.0512S
150.0505	6,0 / 4,8	4,8	6,4	6,4	150.0523	SW 13	150.0513	150.0513S
150.0506	7,0 / 4,8	4,8	6,4	6,4	150.0523	SW 13	150.0513	150.0513S
150.0507	7,0 / 4,8	4,8	8,0	8,0	150.0524	SW 14	150.0514	150.0514S
150.0508	7,0 / 4,8	4,8	8,7	8,7	150.0525	SW 17	150.0515	150.0515S
150.0509	9,0 / 6,5	6,4	8,7	8,7	150.0525	SW 17	150.0515	150.0515S
150.0510	9,5 / 6,5	6,4	8,7	8,7	150.0525	SW 17	150.0515	150.0515S

5270,-

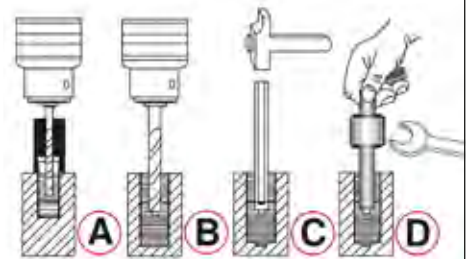

150.1305 M5 - M6 - M8 - M10 - M12 - M14 - M16



Ostale informacije

Alat za odvijanje i vađenje klinova-set

6590,-

- spoljni šestougaoni pogon 21,0 mm
- sa funkcijom desnog i levog zatezanja
- sigurno držanje pomoću 3 pokretna valjka
- zavrtnje i odvrtanje bez komplikovane primene kontriranja navrtki na tiplu
- odgovara i za dugačke tiplove - zato što se radi o prolaznom bušenju



152.1101 M5 - M6 - M7 - M8 - M10 - M12 - M14



Ostale informacije

HSS Co alat za urezivanje navoja-set u industrijskoj kaseti



- univerzalan set
- ravno užlebljena ručna burgija za navoje
- s podesivim ključem i metalnim držačem sečiva
- s meračem navoja i odvijačem
- kobaltom legiran čelik visokog kvaliteta

NJEMU NIŠTA NE NEDOSTAJE



33 x		M3 - M4 - M5 - M6 - M8 - M10 - M12 M14 - M15 - M18 - M20
11 x		M3 - M4 - M5 - M6 - M8 - M10 - M12 M14 - M15 - M18 - M20
6 x		M3-M4 - M4,5-M6 - M7-M9 - M10-M11 - M12-M14 - M16-M20
2 x		M1-M10 - M5-M20

65990,-

331.0754



Ostale informacije

SVI VOLE DA GA NOSE!

3290,-



EN388



4131X

Fino mikro pletivo

	veličina	sadržaj
310.0490	7	12 pari
310.0491	8	12 pari
310.0470	9	12 pari
310.0475	10	12 pari
310.0480	11	12 pari



Ostale informacije

520,-



310.0120

FLAME DESIGN

Ostale informacije





6590,-

310.0155

STEEL DESIGN

Ostale informacije





6590,-

310.0195



Tehnički podaci:

Izbor boje:	bestepeno podešivo od DIN 9-13 Standardno podešavanje svetlosti: DIN 4
Vreme reakcije prebacivanja:	1/25.000 s 0,2 - 0,8 s odlaganje (podešivo)
UV/IR zaštita:	prema EN169 / do DIN 16
Radna temperatura:	-5°C do +55°C
Temperatura skladištenja:	-20°C do +70°C
Snabdevanje struje:	preko solarnih ćelija
Visina:	220 mm
Širina:	200 mm
dužina:	295 mm
Težina:	480 g
Dimenzije kasete:	110 x 90 x 9 mm
Kontrolni prozor:	92 x 42 mm

Univerzalni raspršivač s pumpom za pritisak

Ostale informacije

- od kvalitetnog polietilena
- za različite hemikalije kao npr. sredstva za pranje, rastvaranje i čišćenje itd.
- ne odgovara za sredstvo za čišćenje kočnica
- glava raspršivača od mesinga, može da se podešava i zatvara
- zaptivke od vitona
- odgovara za radove iznad visine glave







od 1970,-

150.8251	1 L	1970,- RSD
150.8252	2 L	2630,- RSD

Aluminium

Ostale informacije

0,25 L

max. 8 bar (116 psi)

60°C / 140°F

115 mm

250 mm

NOVO

specijalno za čišćenje kočnica





6590,-

150.8272

i  **16**
Ostale informacije

EVOLUTION SERIES

Preklopni grebač-set

- idealno za skidanje plaketa, ostataka zaptivki i lepka
- jednostavna zamena sečiva odvijanjem zavrtnja na zateznoj glavi
- praktičan sistem čuvanja pomoću promenljivih oblika sečiva
- odgovara za različite oblasti primene zahvaljujući različitim sečivima
- grebač s 2-komponentnom drškom

Rezervna sečiva: 907.2202, 907.2203, 907.2204, 907.2205, 907.2206

NOVO

5x  12 mm
5x  16 mm
5x  20 mm

145 mm

1710,-

907.2255

i  **27**
Ostale informacije

Nož-grebač-set

5x  19 mm

145 mm

5x  12 mm
5x  16 mm
5x  16 mm
5x  20 mm

145 mm

2630,-



907.2200

Skidač nalepnica

A  **B** 

110 mm 145 mm

od 520,-

A	907.2240			1	110 x 39 mm	520,- RSD
B	907.2242			1	145 x 40 mm	650,- RSD

Preklopni nož sa aretirnim elementom

A  **B** 

190 mm 220 mm

A	907.2105			1	190 x 25 mm	1440,- RSD
B	907.2190			1	220 x 28 mm	1580,- RSD

od 1440,-

i  **2**
Ostale informacije

155 mm 97 mm

1970,-

Sklopiv nož-set

907.2172

i  **3**
Ostale informacije

5270,-

250 mm

Makaze za lim s polugom-set

118.0050

Set Wi-Fi videoskopa sa Ø 5,5 mm 0° HD sondom sa prednjom kamerom

5 Ostale informacije

HD

WiFi

Ø 5,5 mm

Ø 5,5 mm

3500 mm

IP68

5270,-

550.7560

EXTEND YOUR EYE

od 31670,-

Čaura od oplemenjenog čelika
Navojni priključak za прибор

Krunski dizajn (zaštita + optimalno čišćenje)

kamera
sočivo
LED
Čaura od oplemenjenog čelika sa spolnim navojem
Safirmo staklo

Ø 6,0 mm

Ø 4,5 mm

1500 mAh Li-polymer

PUSH 0 / 90°

1000 mm

Priključak sonde

3,5"

USB 2.0

microSD

HD

6 bele mini LED lampe s prigušivačem

0° 90°

Ø

A 550.7500 **5** 6,0 mm 0° + 90° 31670,- RSD

B 550.7530 **7** 4,5 mm 0° + 90° 39590,- RSD

1000 mm

50 mm

IP 67

AVI 1280 x 720

JPG

150 mm

-10°/+60°C

magnet

Kuke





Ostale informacije



Ø
3,9 mm

6 bele mini
LED lampe s
prigušivačem

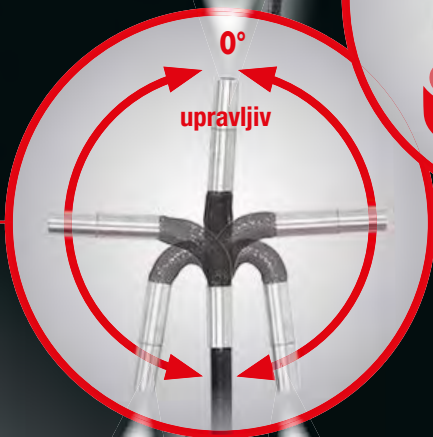

Priključak sonde



USB 2.0



microSD



3000 mAh
Li-polymer

IP
67

AVI
1280 x 720

JPG

150 mm

-10°/+60°C

NOVO

59390,-

+ 32 GB

550.7550

Set HD videoskopa sa Ø 3,9 mm 180° i 0° HD sondom
s prednjom kamerom, fleksibilna PVC navlaka





Ø 12 - 35 MM

104.5060 **Inox Steel**

Cevasti sekač sa ustavljačkim točkom

5270,-



Ø 28 - 67 MM

104.5050 **Inox Steel**

Cevasti sekač sa ustavljačkim točkom

17150,-



116.1050



FUGENFIX™

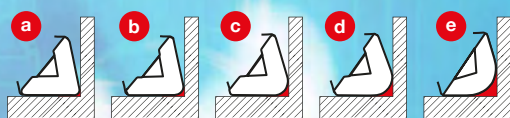

1050,-

FUGENFIX set grebača i skidača silikona



903.3300

Alat za popravku navoja-set
3/8" - 1.1/4"

10550,-

3/8"
1/2"
3/4"
1"
1.1/4"



116.2000



Alat za fiksiranje ventila

7650,-

130.3000

1/2"

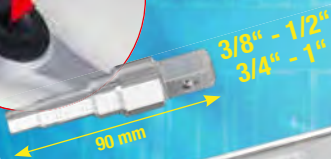

Univerzalni stepenasti ključ-set 3/8" - 1"

2630,-

903.5902

- temperatura oko 1700°C
- radna temperatura oko 650°C
- meko letovanje do maks. Ø 22 mm
- isporučuje se bez patrone za plin
- primena samo sa standardnim gorionicima visoke efikasnosti
- osnovno telo od plastike



Univerzalna lemilica s patronama s Piezo upaljačem

3290,-

907.2113

Japanska testera, dvostruko nazubljenje



17x pro 2,5cm

8x pro 2,5cm

325 mm

2370,-



850.0300

SMARTBAG univerzalna servisna torba

9760,-

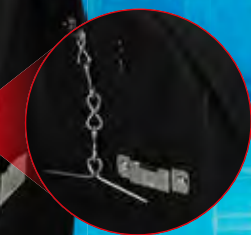

NOVO



Kompaktna i izdržljiva varijanta:

Zahvaljujući kvalitetnim vrstama plastike i jakim navojnim spojevima, akumulator nudi posebno dobru zaštitu od mehaničkih uticaja.



18V eMONSTER aku sistem

Snažan 18V eMONSTER aku sistem objedinjuje niz profesionalnih akumulatorskih električnih alata. Svi uređaji mogu da se koriste sa akumulatorskim sistemom. Asortiman je veoma širok i neprekidno se proširuje. Svaki novi uređaj može se takođe koristiti sa tim akumulatorskim sistemom. Tako možete godinama da koristite ovaj akumulatorski sistem i proširite je sa eMONSTER 18V uređaja - ostaćete u istoj akumulatorskoj porodici.



Odvođenje toplote

Zahvaljujući rebrastoj strukturi, toplota se vodi u vazduh okruženja isto kao u slučaju hladnjaka.



Dodatna zaštita za dug vek trajanja akumulatora:

Zaštita od prenapona:

- Zaštita od nedozvoljeno visokih izvora napona

Zaštita od niskog napona:

- Zaštita od dubokog praznjenja tokom rada

Upravljanje temperaturom:

- interakcija uređaja i baterije radi sprečavanja preopterećenja baterije



Aktivno hlađenje vazduha:

(samo u slučaju 8.0 Ah brzih punjača) Integrisani ventilator brzog punjača 8.0 Ah neprekidno tokom postupka punjenja obezbeđuje svež vazduh kako bi se najbolje moguće smanjila nastala toplota. Zahvaljujući ovom posebnom postupku punjenja povećava se vek trajanja akumulatora.



Optimizovan raspored ćelija:

Struktura cevi pojedinačne ćelije gura u plastiku koja odvodi toplotu. Tako nastaje jak kontakt između ćelije i plastike koja odvodi toplotu. Više nema izolacionog sloja vazduha koji smanjuje odvođenje toplote.





4 eMONSTER Brushless set akumulatorske bušilice/odvijača



4 eMONSTER Brushless set akumulatorske udarne bušilice/odvijača

MINI

2 - brzine

150 mm

190 mm

LED

21110,-

UKLJUČUJUĆI

napon baterije: 18,0 V
maks. struja punjenja: 3 A

napon baterije: 18,0 V
Aku tehnologija: Litijum jonski
Kapacitet baterije: 2,0 Ah

isporučuje se sa dve 2,0h aku baterije i 3A brzim punjačem

2 - brzine

195 mm

195 mm

LED

25070,-

Obrtni momenat maks.: 40 Nm
Pogon: 10 mm stezna glava za brzo otpuštanje

UKLJUČUJUĆI

+

Obrtni momenat maks.: 60 Nm
Pogon: 13 mm Röhm metalna brzopotezna stezna glava



9 eMONSTER 1/2" Brushless set akumulatorskog udarnog odvijača



eMONSTER Brushless set ugaone brusilice

215 mm

190 mm

predizbor obrtnog momenta podesiv u 3 stepena

Zaustavljanje okretanja

15 mm, 17 mm, 19 mm, 21 mm, 22 mm

35630,-

UKLJUČUJUĆI

napon baterije: 18,0 V
maks. struja punjenja: 8 A

napon baterije: 18,0 V
Aku tehnologija: Litijum jonski
Kapacitet baterije: 4,0 Ah

isporučuje se sa dve 4,0h aku baterije i 8A brzim punjačem

230 mm

Ø 125 mm

320 mm

Zatezni ključ u bočnoj drški

6 brzina

1, 2, 3, 4, 5, 6

broj obrtaja: 9000 o/min
Ubrzavanje vibracija: < 4,831 m/s²
3,371 m/s²

39590,-

32 Ostale informacije

NOVO

1/4" TORSIONpower set bitova u eMONSTER aku dizajnu, 32-delni

1310,-

- 1 x 1/4"
- 1 x 1/4"
- 4 x 3 - 4 - 5 - 6 mm
- 4 x PH1 - 2 x PH2 - PH3
- 4 x PZ1 - 2 x PZ2 - PZ3
- 4 x 3 - 4 - 5 - 6 mm
- 7 x T10 - T15 - T20 - T25 - T27 - T30 - T40
- 7 x TB10 - TB15 - TB20 - TB25 - TB27 - TB30 - TB40

+30%

može da se priključi i aretiri na 18V eMONSTER uređaje kao aku imitacija

515.6100

515.6300

515.6200

515.6932

UDARAC ZA UDARCEM!

1.390 N·m

1/2"

90 mm

165 mm

515.1150

1  **26390,-**

1.390 N·m

1/2"

95 mm

190 mm

515.1270

2  **19790,-**

1.084 N·m

1/2"

115 mm

180 mm

515.1315

3  **9230,-**

1.600 N·m

1/2"

170 mm

188 mm

515.1200

4  **9230,-**

2.000 N·m

3/4"

170 mm

185 mm

515.3400

5  **16490,-**

1.690 N·m

1/2" 3/4"

175 mm

200 mm

515.1210

6  **19790,-**

515.3785

7  **25070,-**

3.405 N·m

3/4" 1"

40 mm

350 mm

515.3250

9  **112190,-**

515.3270

11  **112190,-**

3.405 N·m

3/4" 1"

195 mm

350 mm

515.3260

10  **119450,-**

515.3280

12  **119450,-**

													
		Nm	U/min	m/s ²	dB(A)	dB(A)	U/min	PT					Kg
1	515.1150	1/2"	1390	10.000	<9,18	102,0	113,0	135	1/4"	-	✓	-	1,08
2	515.1270	1/2"	1390	10.000	<9,18	102,0	113,0	135	1/4"	-	✓	✓	1,3
3	515.1315	1/2"	1084	9000	<10,36	106,0	115,0	169	1/4"	-	✓	-	1,2
4	515.1200	1/2"	1600	8500	<17,5	89,9	100,9	169	1/4"	✓	-	-	2,1
5	515.3400	3/4"	2000	8500	<17,25	91,0	100,9	196	1/4"	✓	-	-	2,2
6	515.1210	1/2"	1690	7930	<17,9	87,0	98,0	178	1/4"	✓	✓	-	2,1
7	515.3785	3/4"	1690	7930	<13,56	88,0	104,0	178	1/4"	✓	✓	-	2,2
8	512.0002	1/2"	2300	8500	<8,69	99,7	110,9	244	1/4"	✓	-	✓	1,6
9	515.3250	3/4"	3405	6200	<12,57	115,5	104,5	283	1/2"	✓	✓	-	6,7
10	515.3260	3/4"	3405	6200	<12,88	115,5	104,5	283	1/2"	✓	✓	-	7,7
11	515.3270	1"	3405	6200	<12,57	115,5	104,5	283	1/2"	✓	✓	-	6,7
12	515.3280	1"	3405	6200	<12,88	115,5	104,5	283	1/2"	✓	✓	-	7,8

 udarni mehanizam s dva čekića visokih performansi

 Jumbo udarni mehanizam velike snage

 BITURBO tehnologija

Sve cene u RSD, bez PDV-a, važe do 30.9.2024.

i **1**
Ostale informacije

i transport maziva: po jedan izbačaj po aktivaciji okidača

8780,-

515.3900 Pneumatska presa za mazivo za transport maziva pumpanjem

i **1**
Ostale informacije

od 3290,-

PU ✓

515.3330	6,0 mm	G1/4" AG	8,0 m	3290,- RSD
515.3335	8,0 mm	G1/4" AG	15,0 m	4610,- RSD
515.3340	10,0 mm	G3/8" AG	15,0 m	5270,- RSD

i **1**
Ostale informacije

1310,-

može da se reguliše

100 mm

515.1901 Pištolj za ispuštanje komprimovanog vazduha s regulacijom protoka

i **3**
Ostale informacije

2630,-

510 mm

330 mm

95 mm

515.1921 Pneumatski pištolj za izduvavanje-set

Automatski namotač za pneumatsko crevo

15 m

1,5 m

180°

STOP

i **1**
Ostale informacije

15830,-

➔ **Ø 10 MM X 15 M**

515.3440

A

Tehnički podaci:

Unutrašnji prečnik creva: 10,0 mm
maks. pritisak: 20,0 bar
Priključni navoj: 1/4"

i **1**
Ostale informacije

23750,-

➔ **Ø 13 MM X 15 M**

515.3445

B

Tehnički podaci:

Unutrašnji prečnik creva: 13,0 mm
maks. pritisak: 20,0 bar
Priključni navoj: 3/8"

i **1**
Ostale informacije

od
1580,-

	↔	↕	
A	500.8040	480 mm	1580,- RSD
B	500.8045	1.150 mm	5270,- RSD

i **1**
Ostale informacije

1
6590,-

500.8020

i **1**
Ostale informacije

2
7910,-

500.8030

i **1**
Ostale informacije

VISOKO OPTERETIVO DO 135 KG

3
9230,-

500.8004

i **1**
Ostale informacije

4
9230,-

500.8011

i **1**
Ostale informacije

6
13190,-

500.8000

	1	2	3	4	5	6
Tehnički podaci:	500.8020	500.8030	500.8004	500.8011	500.8090	500.8000
Boja	crveno	crveno	crveno	crveno	crveno	crveno
Materijal	čelična cev	metal	metal	metal	plastika	metal
broj upravljačkih točkova	4	5	5	6	6	6
može da se kreće na točkovima	✓	✓	✓	✓	✓	✓
vrsta guma	plastika	plastika	guma	plastika	plastika	plastika
postavljeno	✓	✓	✓	✓	✗	✓
podesivo po visini	✗	✓	✓	✓	✗	✓
sadržaj pakovanja	1	1	1	1	1	1
ukupna dužina D u mm	365,0 mm	370,0 mm	360,0 mm	1040,0 mm	1030,0 mm	1200,0 mm
širina B	360,0 mm	370,0 mm	360,0 mm	490,0 mm	480,0 mm	420,0 mm
visina H	360,0 mm	420,0 - 540,0 mm	463,0 - 580,0 mm	85,0 - 400,0 mm	115,0 mm	145,0 - 510,0 mm
ukupna nosivost kg	90 kg	90 kg	135 kg	90 kg	120 kg	90 kg

i **1**
Ostale informacije

NAJLAKŠI

5
8970,-

500.8090

i **3**

Ostale informacije

Genijalno fleksibilno

1 53 x 29,5 x 3,2 cm

2 25,5 x 23,3 x 2,4 cm

3 27,5 x 14,5 x 2,4 cm

NOVO

5930,-

500.3077 **Set za odlaganje alata, od silikona**

i **1**

Ostale informacije

- sa neklizajućim profilom na pokretnoj platformi
- sa velikom platformom za sigurnu stabilnost
- plastične ivice na stopama štite pokretnu platformu i pod

13190,-

800.0960 **Aluminijumska sigurnosna platforma**



TESTIRAN ZA VAŠU BEZBEDNOST!

i **1**

Ostale informacije

- sa rebrastim limenim profilom na stepeniku
- bez naginjanja usled ukrivo postavljenih nogara
- preklopiva te stoga mogu da se skladište uz uštedu prostora

7250,-

800.0965 **Aluminijumske merdevine**

i

Ostale informacije

max. 8 bar (116 PSI)	60° C 140° F

2630,-

1 Water **2** Detergent **3**

Max. 40° C Max.

4 **5** Switch Lock

150.8271 **Pneumatski crpni raspršivač pene (penilica)**

i

Ostale informacije

11210,-

350 mm

650 mm

500.8013 **Pokretna hoklica**

i

Ostale informacije

6,3 bar	96 L/min
92 dbA	1/4" PT

5270,-

145 mm 3/8" - Ø 10 mm

usisavanje duvanje

515.5090 **Pneumatski usisno-izduvni pištolj**

780,-

515.1243 Brisač folije

2100,-

515.1247 Brisač za foliju sa lamelama

3950,-

515.1285

11870,-

515.1366

CENA PO SETU = 6x

18740,-

515.1980 Pneumatski pištolj za čišćenje

može da se reguliše

1/4" NPT	8000	160 Litara
6,3 bar (90psi)	3/8" 10 mm	<3,90 m/s²
106 dBA	95 dBA	1000 ml

Industrijski kuglični ležajevi

OPCIJE

780,-

515.1983 Dodatak za četke

780,-

515.1986 Četka-četkica

i **6**
Ostale informacije

3950,-

510 mm

4 mm
8 mm
10 mm

4 mm
8 mm
10 mm

245 mm

140.2370 **Alat za otvaranje stezaljki-set**

i **11**
Ostale informacije

2630,-

180 mm 200 mm 200 mm 200 mm 210 mm

160 mm 200 mm 200 mm 180 mm 200 mm 200 mm

911.8205 **MASTER plastični klin-set**

i **1**

Ostale informacije

- otklanja mirise i dezinfikuje unutrašnjost vozila
- automatsko isključivanje u modusu za uklanjanje mirisa posle 60 minuta
- radi bez hemijskih dodatak, stoga garantuje čišćenje bez ostataka
- ne ostavlja tragove ni na osetljivim površinama
- otklanja buđ, bakterije, gljivice i mikrobe

173 mm

49 mm

122 mm

10550,-

550.1183 **Plazma prečistač vazduha sa tehnologijom jonizatora**

i **1**
Ostale informacije

- idealno za čišćenje uzanih cevi, creva ili odvoda
- dvostrano primenljivo
- fleksibilna osovina od nerđajućeg čelika
- najlonske četke

520,- **NOVO**

Ø 16 mm

Ø 22 mm

150.1762 **Fleksibilna četka za čišćenje**

i **7**
Ostale informacije

Ø 0 - 38 mm

Ø 0 - 48,5 mm

Ø 0 - 65 mm

Ø 0 - 30 mm

Ø 0 - 45 mm

Ø 0 - 45 mm

Ø 0 - 60 mm

10550,-

115.1055 **Klešta za objimce za creva za teretna vozila-set**

i **3**
Ostale informacije

1310,-

Ø 15 mm Ø 30 mm Ø 60 mm

150 mm 180 mm 250 mm

115.5050

i **3**
Ostale informacije

1710,-

Ø 15 mm Ø 35 mm Ø 23 mm

155 mm 255 mm 165 mm

115.5055

i **1**
Ostale informacije

1970,-

Ručna pumpa za izvlačenje i punjenje

150.9221

i **1**
Ostale informacije

2630,-

100 mm

3/8" specijalni nasadni ključ za navojne spojeve usisne cevi

150.2519

i **1**
Ostale informacije

2630,-

12V 5A 60W
Richtung Direction
150.2620

Električna pumpa za usisavanje i transfer ulja

150.2620

PETROL DIESEL OIL

i **1**
Ostale informacije

650,-

Zamenski nasadni ključ za crevne obujmice 30-45 mm i 60-80 mm

NOVO

30 mm

2 u 1 specijalnih utičnih ključeva za crevne obujmice sa profilom s 3 tačke

115.0915

i **1**
Ostale informacije

1710,-

NOVO

1/2"

108 mm

Alat za skidanje poklopca hladnjaka za VAG

150.1919





25

Ostale informacije











0 - 2,5 bar

max. 76 cm

0 - 200 °C
0 - 400 °F

1600 mm



R123
R124



R123
R125



#1



#2



#3



M50 x 2,5



M42 x 3



M58 x 3



M62 x 3



M48 x 4



M45 x 3



M50 x 2,5



M60 x 4



M52 x 3



M48 x 2,5



M42 x 2,5



M50 x 3



M46 x 3



M34 x 2,5



75 mm

23750,-

150.1930

MASTER
rashladni sistemi-dijagnostika-servis-set







1

Ostale informacije

Spojnica 7,2 mm na 4,4 mm



7,2 mm



4,4 mm

NOVO

80 mm

2630,-



150.1936





1

Ostale informacije

Spojnica 4,4 mm na 7,2 mm



4,4 mm



7,2 mm

NOVO

74 mm

3290,-



150.1937

i  **8**
Ostale informacije

250 ml

13190,-

150.1910 CO2-tester za curenje glave cilindra-set

OPCIONALNO

1970,-

150.1914

i  **3**
Ostale informacije

GENIJALNO FLEKSIBILNO

53 x 29,5 x 3,2 cm

1

2

25,5 x 23,3 x 2,4 cm

3

27,5 x 14,5 x 2,4 cm

NOVO

5930,-

500.8077 Set za odlaganje alata, od silikona

i 2
Ostale informacije

EcoBoost

NOVO

180 mm + 215 mm

14 mm + 16 mm

3290,-

ZA FORD ECOBOOST MOTORE 1,0 LITARA

ZA FORD ECOBOOST MOTORE 1,5 LITARA

517.1135 **Set nasadnih ključeva za svećice za EcoBoost motore**

i 2
Ostale informacije

M20 x 1.5 + M22 x 1.5

27 mm

13 mm

sa 6 sečiva za idealno centriranje

sa žlebovima za čišćenje u vodicama

23750,-

150.2540 **Set urezivača navoja sa vodicom za senzorom**

- za naknadno urezivanje zardalih i oštećenih navoja sonde
- idealno za NOX senzore i senzore filtera za čestice na izduvnim sistemima
- sa 6 sečiva za idealno centriranje
- posebno kratka varijanta
- sa žlebovima za čišćenje u vodicama

GENIJALNO REŠENJE PROBLEMA

NOVO

i 1
Ostale informacije

Sekač navoja sa vodicom

• za naknadno urezivanje zardalih i oštećenih navoja sonde

13 mm

sa 6 sečiva za idealno centriranje

sa žlebovima za čišćenje u vodicama

13190,-

			L1	L2			
A	150.2541	za senzore temperature	M12 x 1,25	55 mm	33 mm	13 mm	13190,- RSD
B	150.2542	za senzore temperature	M14 x 1,5	45 mm	30 mm	13 mm	13190,- RSD
C	150.2543	za lambda sonde	M18 x 1,5	42 mm	27 mm	13 mm	13190,- RSD
D	150.2544	za NOX senzore	M20 x 1,5	50 mm	27 mm	13 mm	13190,- RSD
E	150.2546	za senzore filtera za čestice	M22 x 1,5	50 mm	27 mm	13 mm	13190,- RSD

i  **1**
Ostale informacije **2630,-**



1 **2**

500.7505 Skidač kalema za paljenje za štapne kaleme za paljenje



i  **7**
Ostale informacije **ZA VAG I OPEL MOTORE**

9230,-



1 **2** **3** **4** **5** **6** **7**

500.7570 Set skidača kalema za paljenje s T-ručkom-set za VAG i Opel motore



i  **7**
Ostale informacije

120 ml 120 ml



6x10
6x6
6x8
6x4
600 mm
Ø 6x9 mm

22430,-

150.1900 Pumpe za pritisak i potpritisak, set



i  **24**
Ostale informacije



6590,-

700.1280 Univerzalni montažni alat za zaptivni prsten osovine i zaštitni prsten-set



i  **1**
Ostale informacije



max. 165 mm

5270,-

M 12 x 75 mm

3/8" 17 mm

30 mm

40-165 mm

150.3170 Univerzalni skidač remenice Ø 40-165 mm

i  **1**
Ostale informacije

NOVO

1/4" 13 mm

- za zatezanje i otpuštanje remenice
- zupčastog kaiša
- podesivo, univerzalno primenljivo
- unutrašnji četvorougao ni pogon prema DIN 3120 / ISO 1174
- sa spoljnim šestougaonim pogonom 13,0 mm
- fosfatizovano

Ø 3,0 mm

8 - 25 mm

2630,-

150.3046 Univerzalni čep ključ za remenice zupčanika, podesiv

i  **1**
Ostale informacije

Oblasti primene: Citroën, Peugeot, Opel i Toyota sa 1,0 i 1,2 benzin motorima (šifra motora: ZMZ (EB0F / EBO) / HM01 (1PP) / HMV, HMZ (EB2) / HMZ (EB2 / EB2F) / HMT (EB2D) / HMU (EB2D) / HNZ (EB2DT) / HNY (EB2DTS) / HMV (EB2M) / HMY (EB2M) / B12XE (EB2F) / D12XE (EB2FA) / B12XHL (EB2DT) / D12XHL, F12XHL (EB2ADT) / B12XHT (EB2DTS) / D12XHT, F12XHT (EB2ADTS))



1310,-

400.2118 Alat za ispitivanje zupčastog kaiša za PSA

i  **1**
Ostale informacije

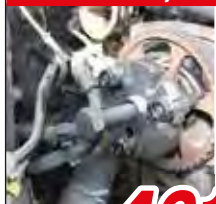

M 15 x 1,5 x 71 mm

17 mm

27 mm

70 mm

4610,-

150.3130 Univerzalni skidač remenice 3-kraki

i  **22**
Ostale informacije



- za montažu i demontažu CLIC opružnih zatvarača-spojnika provodnika koji se teško otvaraju, na provodnicima za gorivo, provodnicima za klima uređaje, pneumatskim i hidrauličnim provodnicima
- bez oštećenja utičnih spojnica, provodnika goriva i creva za gorivo
- brzo i jednostavno razdvajanje provodnika goriva
- za skoro sve spojnice provodnika na evropskim, azijskim i američkim vozilima



115.1260 Set alata za otključavanje spojnica provodnika



6590,-



5/16" 1/4" 5/16" 3/8" 3/8" 1/2" 5/8" 7/8"

3/8" 1/2" 5/8" 3/4" 5/16"

3/8" 1/2" 5/8"

3/4" 7/8" 5/16" x 3/8"

5/16"



Ostale informacije

SA 3.873 UDARACA U MINUTU IZVLAČI SVE!

- sa 7 adaptera za skoro sve ubrizgivače
- izuzetno visok udarni efekat za skoro sve ubrizgivače (3365 (6,3 bara) / 3873 (8 bara) udaraca u minutu)
- za demontažu zapekljih ubrizgivača u glavi cilindra
- sa odgovarajućim adapterom izvlačać se uvrće na zapeklu mlaznicu za ubrizgavanje
- neznatna potreba prostora usled kompaktne građe

NOVO



A

B

C



D



E

F

G

H



3.873 x / min



1/4"

može da se reguliše

223 L/min	3/4"-19 mm	108,4 dbA
6,3 bar (90 psi)	71,9 m/s ²	6 mm
12 bar	119,4 dbA	M18 x 1,5

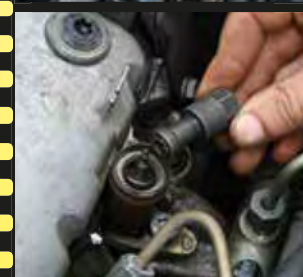
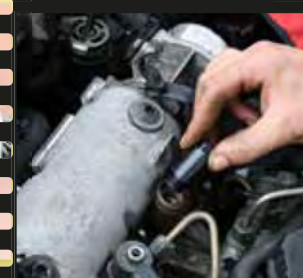
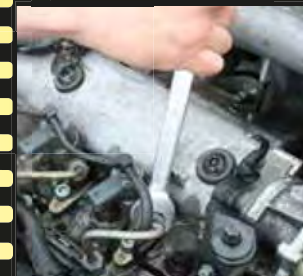

A	M25 x 1,0	Siemens
B	M20 x 1,0	Denso
C	M27 x 1,0	Siemens
D	M27/M17/10 mm	Bosch/Fiat/BMW/PSA/ Mercedes/Renault
E	M18 x 1,5	Adapter
F	M17 x 1,0	Bosch/Mercedes
G	M16 x 1,0	Toyota
H	M14 x 1,5	Bosch/Delphi/BMW



230 mm

**BOSCH
DENSO
DELPHI
SIEMENS**



...

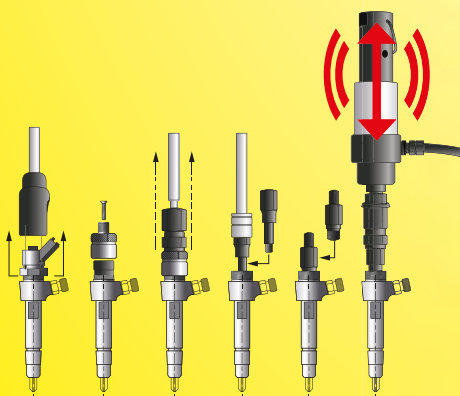

35630,-

152.1130 Set pneumatskih alata za izvlačenje ubrizgivača

6
Ostale informacije

285 - 875 mm

TELESKOPSKI

150 - 675 mm

500g

200g

1000g

2000g

3000g

Ø 4 mm

Ø 13 mm

Ø 16 mm

Ø 19 mm

400 mm

510 mm

NOVO

3560,-

550.1090 **Set fleksibilnih i teleskopskih magnetnih držača i kontrolnih ogledala**

1
Ostale informacije

125 mm

6 - 24 V

650,-

550.1504 **Ispitna lampa 6 - 24 V**

1
Ostale informacije

1580,-

3 - 48 V

Ispitivač polariteta i napona

550.1503

3 - 48 V

2
Ostale informacije

17150,-

25 m

6 - 24 V

Lampa za kontrolu funkcionalnosti

150.1655

2
Ostale informacije

7910,-

1 Prijemnik

2 Odašiljač s krokodil klemama

150.3075 **Detektor kratkog spoja**





Ostale informacije







 **Punjenje baterije**
 **Punjenje za održavanje**
 **Popravka baterije**
 **Jednosmerno napajanje**

12V
24V

prebacivo između 12 i 24 V

48830,-

Senzor temperature



Tehnički podaci:

Kapacitet baterije:	12V: 75-500Ah - 24V: 45-250Ah
Oblast napona:	220-240V AC, 50/60HZ
Napon punjenja:	14,4V - 25A (12V), 28,8V - 12,5A (24V)
Oblast frekvencije:	50 Hz
Provodnik:	H05RN-F 2x1,0 mm ²

550.1745 12V + 24V SMARTcharger visokofrekventni punjač baterija 25A/12,5A







Ostale informacije









48570,-



MF

WET

AGM

VRLA

GEL

✓

12 V / 24 V digitalni tester za sisteme baterija i punjača sa integrisanim štampačem

550.1649

Za skoro sve baterije

Sa štampačem i 3 rolne papira



Tehnički podaci:

Indikator:	digitalno
Radna oblast CA / MICA:	40-2.000 CCA
Radna oblast CCA:	40-2.000 CCA
Radna oblast DIN:	40-2.000 CCA
Radna oblast EN:	40-2.000 CCA
Radna oblast IEC:	40-2.000 CCA
Radna oblast JIS#:	40-2.000 CCA
Radna oblast SAE:	40-2.000 CCA
Radna temperatura:	0°C do +55°C
Oblast frekvencije:	100 Hz
Merna oblast:	9-36 V
Preciznost merenja:	+/- 0,5 Megaohm
Oblast napona:	9-36 V





Ostale informacije

















Inteligentan sigurnosni koncept sprečava korisničke greške:

sigurnosni prekidač šalje struju na stezaljke tek:

- kada je korektno priključena (polovi)
- kada je priključak osiguran od kratkog spoja
- kada postoji ispravan napon
- kada je baterija vozila ispravna

79190,-

12 V pojačivač za baterije - mobilan pomoćni startni uređaj 1400 A

550.1720

1.400 A



Ostale informacije



3/8"

43550,-

Set alata sa izolovanim alatima za hibridna i električna vozila

117.1895

2 x		4 mm - 5,5 mm
2 x		PH1 - PH2
6 x		6 - 8 - 10 - 12 - 13 - 17 mm
1 x		185 mm
1 x		165 mm
1 x		3/8"
1 x		3/8": 200 mm
1 x		3/8": 125 mm
10 x		3/8": 8 - 10 - 11 - 12 - 13 - 14 - 16 - 17 - 19 - 22 mm
1 x		200 mm



Ostale informacije



3/8"

74570,-

Set alata sa izolovanim alatima za hibridna i električna vozila

117.1890

4 x		2,5 - 3 - 3,5 - 4 mm
3 x		PH1 - PH2 - PH3
3 x		T20 - T25 - T30
1 x		210 mm
1 x		185 mm
1 x		165 mm
1 x		215 mm
1 x		165 mm
1 x		240 mm
2 x		10 - 25 mm
1 x		180 mm
1 x		3/8"
15 x		3/8": 6 - 7 - 8 - 9 - 10 - 11 - 12 - 13 - 14 - 16 - 17 - 18 - 19 - 20 - 22 mm
2 x		3/8": 150 - 250 mm
3 x		3/8": M8 - M10 - M12
1 x		Ø 200 mm
1 x		200 mm
1 x		500 m



Ostale informacije



43550,-

Set viljuškastih ključeva sa zaštitnom izolacijom

118.1500

18 x		7 - 8 - 9 - 10 - 11 - 12 - 13 - 14 - 15 - 16 - 17 - 18 - 19 - 20 - 21 - 22 - 23 - 24 mm
------	--	---



Ostale informacije

<44.500 V



1.680 mm

23750,-

Izolovana šipka za spasavanje

150.0913





Ostale informacije

POČETNI SET ZA ELEKTROMOBILNOST

ecoLine



1

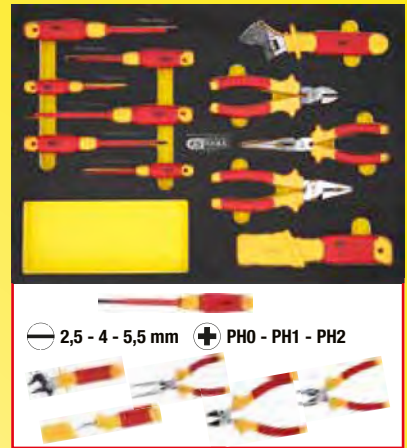

2,5 - 4 - 5,5 mm PH0 - PH1 - PH2

2

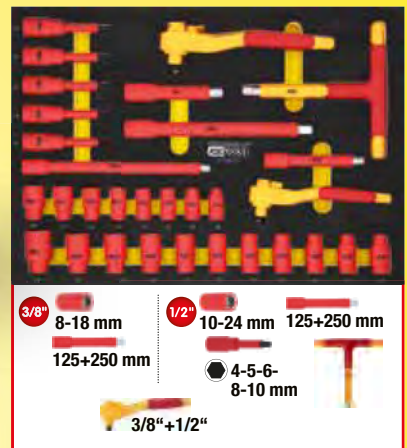

3/8" 8-18 mm 125+250 mm
1/2" 10-24 mm 125+250 mm
4-5-6-8-10 mm
3/8"+1/2"



Kvadratne perforacije za delove pribora

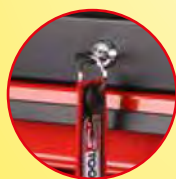

može da se zaključa pomoću ugrađene cilindrične brave



radna ploča sa penastom podlogom debljine 10 mm



sa samouvlačenjem i SOFT-CLOSE funkcijom



2 x kočnice kotrljanja i okretanja
Ø točkova: 125 mm

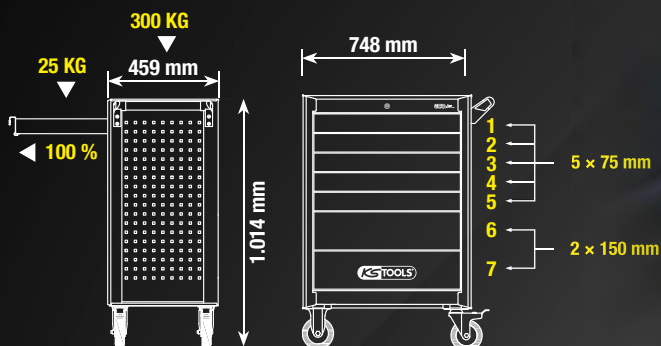

ECOline radionička kolica sa 42 izolovana alata za hibridna i električna vozila

117.6144

171470,-

SA 42 ALATA

567470,-



117.6172 3/8" +1/2" set izolovanih utičnih ključeva sa moment ključem u ulošku od pene, 72-delni



117.6133 Set izolovanih ključeva u ulošku od pene, 33-delni

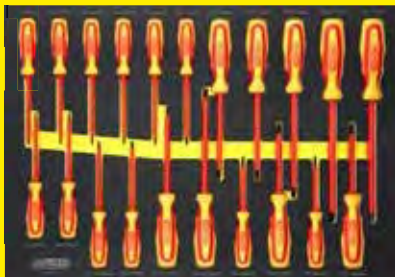

117.6121 ERGOTORQUE VDE set odvijača u ulošku od pene, 21-delni



117.6117 ERGOTORQUE VDE set klešta u ulošku od pene, 17-delni

Hibrid blic tabla sa upozorenjem

200 mm

917.3898

Hibrid prekidač tabla sa upozorenjem

Ø 200 mm

917.3897

Izolaciona prostirka, 1000 mm, debljina 3,0 mm

117.3819

Donja rukavica

117.1660

Električarske zaštitne rukavice sa zaštitnom izolacijom, veličina 10, debljina 1, bele

300 mm

117.1664

Zaštita za lice za električare, klasa 2

117.1796

117.6155 PERFORMANCEplus radionička kolica e10 sa 164 izolovana alata za hibridna i električna vozila

NAJOBIMNIJI U SVOJOJ KLASI

1310,-



117.0223 Krovni stalak sa simbolom munje i magnetom



1310,-

117.0222

Krovni stalak sa simbolom munje i vakuumskim držačem



1970,-

117.0226

Stalak sa simbolom munje

9230,-

117.1550

Set stubova za ograđivanje s lancem

2x

18470,-

117.1545

2 x Ograda od plastike



Katalog za elektromobilnost sa 188 strana možete videti na www.kstools.com

i  **4**
Ostale informacije

Ø 22,0 - 28,0 mm

Ø 15,0 - 21,0 mm

Ø 17,0 - 25,0 mm

Alat za centriranje spojnice-set

1180,-

150.2180 Ø 15,0 - 28,0 mm



i  **11**
Ostale informacije

150 kg

310 mm

450 mm

300 mm

52130,-

160.0910 **Set univerzalnih nosača prenosnika**



i  **3**
Ostale informacije

- Alat za punjenje A montaža i demontaža
- ispuštanje ulja, mali protok
- provera nivoa napunjenosti
- ispuštanje ulja, pun protok

3290,-

9G-TRONIC

56 mm

74,5 mm

20 mm

26,5 mm

9 mm

39,5 mm

9 mm

152 mm

48 mm

150.9695



i  **24**
Ostale informacije

NAJOBIMNIJI!

150.9261		1/8-27 NPT Ford
150.9262		BMW, Honda, Nissan etc.
150.9263		VAG
150.9264		VAG, Porsche
150.9265		M10 x 1.0 VAG, Mini Cooper
150.9267		M12 x 1.5 Mercedes
150.9268		M24 x 1.5 VAG DSG
150.9269		M22 x 1.5 VAG CVT
150.9271		M18 x 1.5 Skoda
150.9272		M30 x 1.5 VAG, Skoda
150.9273		Universal Flexible 300 mm, Honda, Hyundai, Kia, etc.
150.9274		5/16-24 (UNF) Volvo
150.9276		M18 x 1,5 Toyota / Lexus
150.9277		M8 x 1,0 Nissan / Infinity
150.9278		ATF-Adapter V.W, Passat
150.9562		Nissan Juke M12 x 1,25
150.9563		Mini Cooper M14 x 1,5
150.9564		issan M10 x 1,5
150.9566		GM M12 x 1,75
150.9567		Mercedes 725-9G
150.9102		VAG 7 DSG
150.9103		VAG 7 DSG
150.9104		VAG 7 DSG

26390,-

SA SETOM ADAPTERA OD 23 DELA

NOVO!

150.9105 **Univerzalni sistem za punjenje ulja u prenosnik sa 23-delnim setom adaptera**



i  **4**
Ostale informacije



14780,-

Ø 30 mm

McPherson držači amortizera za dizalicu prenosnika

160.0195

i  **7**
Ostale informacije



6 mm

13190,-

Specijalni pomoćni montažni alat za amortizere-set za amortizere sa vučnom oprugom sa graničnikom





1

2

3

4

150.9545

TÜV SÜD **TESTIRAN ZA VAŠU BEZBEDNOST!**

i  **6**
Ostale informacije

univerzalan za 90% svih uobičajenih opruga za vozila u putničkoj i transportnoj oblasti



Ø 140 - 195 mm

Ø 80 - 160 mm

OPTERE ENJE maks 26000 N

59660,-

Univerzalni zatezač opruga-set

500.8400

Tehnički podaci:

kapacitet opruge:	2600 kg
Zatezna širina maks.:	355,0
pritisak opruge maks.:	80,0 - 195,0 mm

- idealan za sigurnu montažu i demontažu Mc Pherson držača opruge
- potrebno za zamenu amortizera ili opružnih zavrtanja
- univerzalan za 90% svih uobičajenih opruga za vozila u putničkoj i transportnoj oblasti
- povoljna i solidna alternativa uobičajenim zatezačima opruga
- odgovara i za konusne i kuglaste opruge
- sa TÜV dozvolom



TESTIRAN ZA VAŠU BEZBEDNOST!

i **11**
Ostale informacije

1/2" x 1/2", 100 Nm
Ø 30 mm

Ø 90 - 140 mm

49230,-

500.8765 Audi i Seat set teleskopskih centrirnih zatezača za unutrašnje opruge

ZA PROŠIRENJE

i **2**
Ostale informacije

Ø 95-110 mm

**ZA ZATEZAČ OPRUGA
500.8755 + 500.8765**

Oblasti primene:
MercedesE klasa (W211 / W212), C klasa (W204), GLA (X156), GLK (X204),
FordFocus II (MK2),BMW1 (E81),VolkswagenPassat (B8 / 3G)

13190,-

500.8770 Par držača opruga, Ø 95-110 mm

ZA PROŠIRENJE

i **9**
Ostale informacije

Ø 30 mm

Ø 90 - 140 mm

Ø 75 - 115 mm

44740,-

500.8755 Univerzalni teleskopski centrirni zatezač-set za unutrašnje opruge

WARNING - ACHTUNG - ADVARSEL
ADVERTENCIA - AVERTISSEMENT

ZA 95% SVIH VOZILA



Ostale informacije

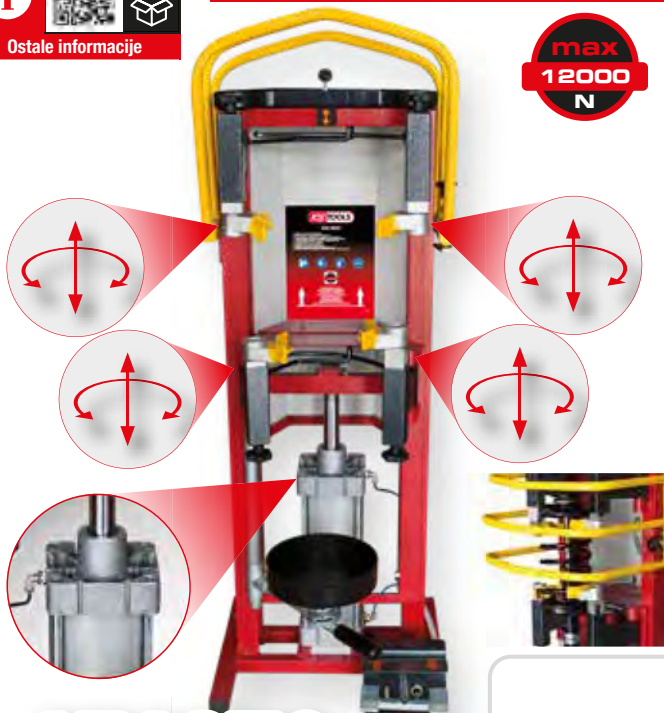

max
12000
N

151670,-

Pneumatski zatezač opruga,
maks. 10 bara

500.8800



Ostale informacije



max
24000
N

211070,-

Nivo komprimovanog vazduha u
zatezaču opruge s duplim cilindrom

500.8810



Ostale informacije

- jednostavno rukovanje
- specijalan čelik za alate
- idealno za prihvat opruga
- optimalno za sigurno stajanje prilikom montaže i demontaže
- sa 4 fiksirna klina i 4 navojna klina
- isporučuje se sa 2 uskočnika za montažu

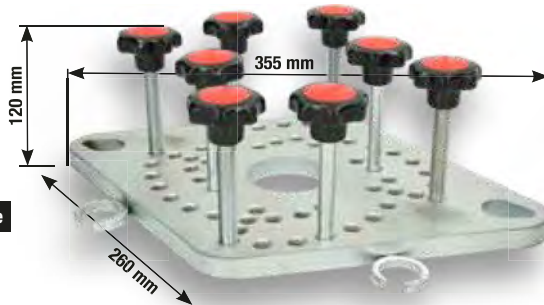

37220,-



500.8801 Adapter ploča za pneumatski zatezač opruge

SET OPRUŽNIH ZATEZAČA SA PLOČOM ADAPTERA



Ostale informacije

Opružni zatezač za
merenja
komprimovanog
vazduha sa
adapter-pločom

178070,-

500.8805



Ostale informacije

Zatezač opruge nivoa
komprimovanog
vazduha sa duplim
cilindrom i pločom
adaptera

237470,-

500.8815

MODULO 2 UREDNOST JE

KONFIGURIŠITE PO SVOJOJ ŽELJI

440.9051



158390,-



VEĆI
NEGO
ŠTO
IZGLEDA

KOČNICA



440.9087



329990,-

SILEN-LEŽAJ



440.9025

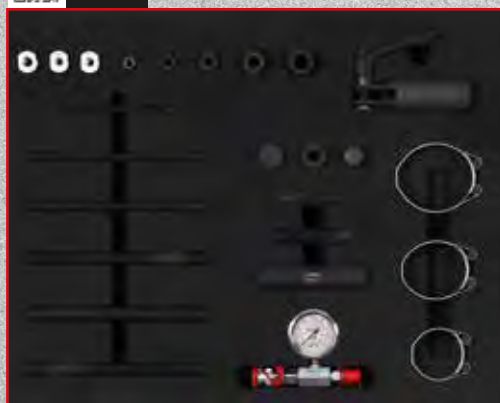

HIDRAULIČNI CILINDAR
BEZ AKTIVACIONIH ALATA

440.9161



448790,-

KOMPAKTNI LEŽAJ TOČKA



440.9026

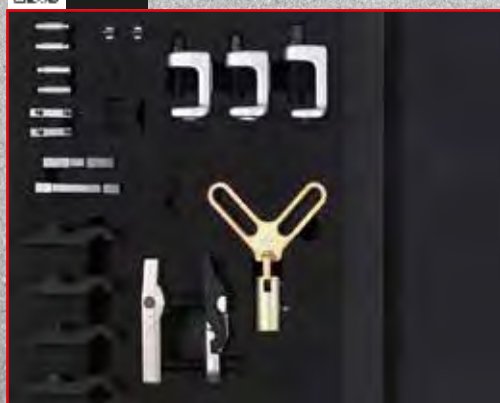

OSOVINA



POLA ŽIVOTA

MODULO 2



P40

EDELSTAHL
ROSTFREI

www.kstools.com

KS TOOLS

Ø 155 mm

1.701 mm



873.6008

PERFORMANCEplus P40 CRNO/CRVENA
radionička kolica sa 4 fioka

364390,-

BEZ ALATA



Ostale informacije

118790,-

Set hidrauličnih pumpi
sa policom za P40

440.9004

131990,-



440.9076



25

LEŽAJ TOČKA



76

105590,-



440.9061

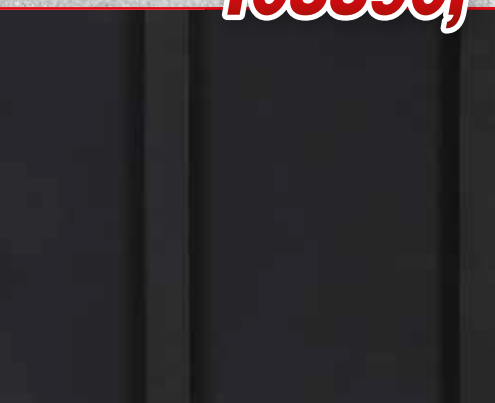

26

AMORTIZER



61

250790,-

i   **1**
Ostale informacije

13190,-

max. 8 bar

450 mm

1/4" PT

za univerzalne manžetne osovine

515.3100 Pneumatski montažni uređaj za manžetne osovine



i   **1**
Ostale informacije

100 mm

Ø 30 mm

255 mm

6590,-

150.1850 Univerzalni skidač zglobnog vratila



i   **1**
Ostale informacije

0 - 45 mm

270 mm

5270,-

115.1056 Klešta za creva za zatezanje obrtnim momentom



i   **1**
Ostale informacije

max. 12 mm

6590,-

115.1590 Zatezna klešta za čelične vezice za kablove s kuglastim zatvaračem

od 3420,-

Čelična vezica za creva za objumice za creva bez ušica
200 - 350 mm

115.1591		 100	4,6 × 200 mm	3420,- RSD
115.1592		 100	4,6 × 250 mm	3420,- RSD
115.1593		 100	4,6 × 350 mm	3820,- RSD
115.1594		 100	4,6 × 500 mm	5010,- RSD



i   **1**
Ostale informacije

UNIVERSAL

10 mm

5270,-

700.5662 Raširni alat za rupe stezaljki



i **1**
Ostale informacije

3290,-

Specijalni nasadni ključ sa nosećim zglobom Mercedes

150.1721 Mercedes W167, W205, W213, W238, W253, W25

i **6**
Ostale informacije

48830,-

Vibro-Impact pneumatsko čekić dleto-set

515.3880

VIPRO

152880316

110 mm

10 mm

110 mm

10 mm

130 mm

10 mm

100 x 25 x 12 mm

31 x / sec.

i **3**
Ostale informacije

4220,-

Istiskivač zateznih zavrtneja-set

700.5635

10 mm

i **1**
Ostale informacije

21110,-

Vibro-Impact alat skidanje spona

150.1608

- odvijanje spona, kontranavojnica ili navojnica zaštićeno od vibracija u oblasti osovine itd.
- specijalni vibrirajući trn šalje udarni impuls na navojni spoj koji treba olabaviti, odvajajući pritom rdu i podržavajući proces otpuštanja
- pneumatski dleto adapter (10 mm) za primenu sa uobičajenim pneumatskim dleto udarnim čekićem

27 mm

290 mm

10 mm

65 mm



Ostale informacije



22300,-

700.1495 Univerzalna poluga osovine sa lancem



- fleksibilan lanac omogućava sigurno potiskivanje poprečnih upravljača različitih modela bez velikog napora



Ostale informacije

16100,-

- stabilno trapezno navojno vreteno
- nožna pedala za fino podešavanje (20mm)
- idealan pomoćnik u radionici u brojnim situacijama



160.0342 Teleskopski podložni potpornik



Ostale informacije



11870,-

911.6187 Teleskopska metalna poluga sa obrtnom glavom



Ostale informacije

13190,-



700.1465 Ispitivač okretanja osovine



Ostale informacije

SA BRZIM ZAKLJUČAVANJEM



59660,-

1000 W

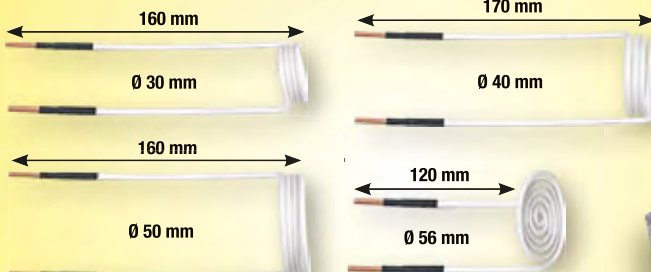

500.8605 Induktivni grejni pištolj-set



OPCIONALNO

17150,-

500.8440

2. GENERACIJA - 2. GENERACIJA - 2. GENERACIJA - 2. GENERACIJA



Ostale informacije

**ZAKAČI
GA!**

NOVO

1970,-

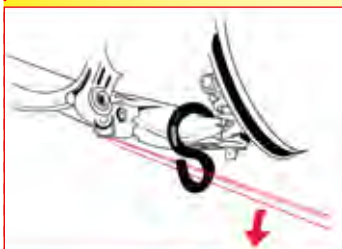

Univerzalna kuka
za podizanje
osovina

700.1499

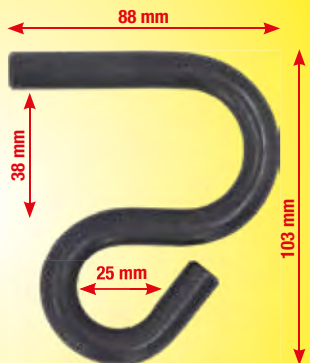

specijalan oblik omogućava postavljanje veoma blizu nosećeg zgloba

specijalna poluga za profesionalnu i pažljivu montažu i demontažu osovinskih delova



Ostale informacije

- 1 x
- 2 x
- 9 x Ø 38 - 40 - 42 - 50 - 52 - 54 - 62 - 64 - 66 mm
- 13 x Ø 34 - 36 - 44 - 46 - 48 - 56 - 58 - 60 - 68 - 70 - 72 - 75 - 80 mm
- 4 x

M10x1,5
M12x2,0
M14x2,0
M16x2,5



700.1550 Potisne i vučne čaure-set

39590,-



i **22**
Ostale informacije

42 40 38 36 34
32 30 28 26 24
#1
#2
#3
#4
M12
M10
M12 M10 TR20

700.2355 Potisne čaure raznih veličina-set **65990,-**

i **4**
Ostale informacije

10550,-

30-35 mm 35-40 mm 40-45 mm
360 mm
1/2" / 32 mm

150.1125 Specijalni ključ za aksijalni zglob-set

i **2**
Ostale informacije

M12

NOVO

115 mm 72 mm

2630,-

Specijalan teretni bit-nasadni ključ-set za zupčaste (XZN®) zavrtnje

515.0595 1/2"

i **30**
Ostale informacije

4,3 Kg

1 x Ø 90 - 130 mm
1 x
4 x M 14
4 x M12 x 1,25
M12 x 1,5
M12 x 1,25
M12 x 1,5
M14 x 1,5
1 x M18 x 2,5 x 230 mm M57 x 2

29690,-

700.1530 Set univerzalnih skidača glavčina točka i zglobnih osovina

MANJE RADNE SNAGE, VIŠE PROFITA.

ODVAJANJE VETROBRANA BEZ POMOĆNIKA!

140.2630

Univerzalni rastavni uređaj za diskove za samostalan rad

- idealno za profesionalno i pažljivo vadenje zalepljenih vetrobrana, kao i većine bočnih i zadnjih stakala
- sa velikom skretnicom čime se smanjuje potrebna snaga i minimizuje opasnost od kidanja žice
- vođenje neposredno ispred ploče, na taj način u većini slučajeva nije potrebna komplikovana demontaža tapaciranih mesta
- lako rukovanje za koje je dovoljna jedna osoba
- posebno kvalitetna vakuum jedinica za sigurno držanje na staklu



13

Ostale informacije



ONE MAN CUT

NOVO

Set profesionalnih zaštitnih tabli,
4-delni
2x 270x200 mm + 2x 450x300 mm

najlon, 50 m

Povratni valjak

Vakuumski tanjir Ø 50 mm

Vakuumski tanjir Ø 50 mm

Fiksator žice za sečenje

4-ivična žica, 50 m

Usisna snaga: 110 kg

Vakuumski tanjir Ø 150 mm

Otpusna poluga

Fiksator žice za sečenje

Visokokvalitetan
pumpni usisivač

6-ivični pogon, 30 mm

Usisna snaga:
110 kg

Sonda za uvođenje žice
za sečenje, 290mm

Povratni valjak

Usisna snaga:
110 kg

Zaštitna tabla, pod uglom

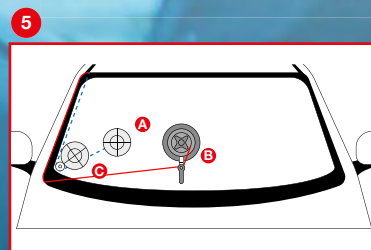
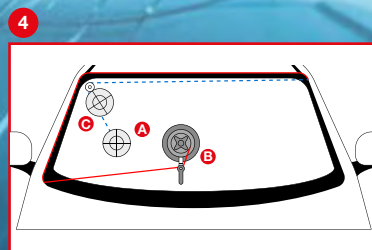
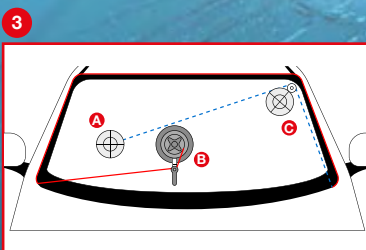
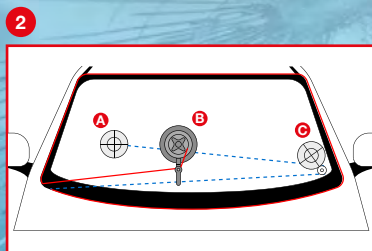
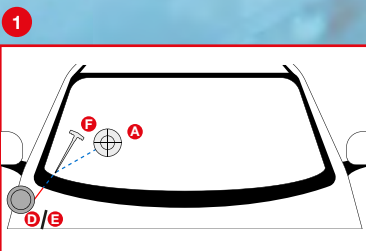

79190,-

Uključujući

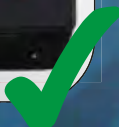
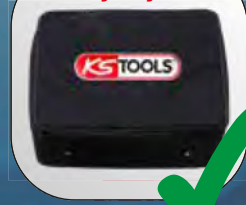

NOVO

1
Ostale informacije

I ZA DOT5.1, ENV4 I ENV6

- Dot3 ✓
- Dot4 ✓

0 20 mm

155 mm **1970,-**

150.1969 **Tester kočione tečnosti za DOT i ENV**

1
Ostale informacije

VITON®
EKM

3690,-

150.8258 **Boca sa raspršivačem za sredstvo za čišćenje kočnica**

specijalno za čišćenje kočnica

2
Ostale informacije

1440,-

150.1935 **Set univerzalnih kuka, mogu da se oblikuju**

2
Ostale informacije

1970,-

150.2235 **Set univerzalnih kuka, krute**

12
Ostale informacije

6590,-

150.2400 **Specijalan nasadni ključ za telo kočnice-set**

1/2" 11,5 mm 14 mm 15 mm 20 mm AS 22 mm

1/4" 9 x 20 mm

3/8" 7 x 72 mm
7 x 92 mm
9 x 50 mm
11 x 100 mm

3/8" 7 x 25 - 8 x 25 mm

41
Ostale informacije

13190,-

150.1970 **Alat za vraćanje kočionih klipova-set**



Ostale informacije

UNIVERZALNI GENIJE



UNIVERSAL
Za 95% svih vozila

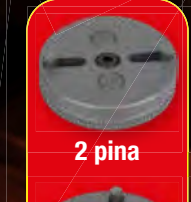

2 pina

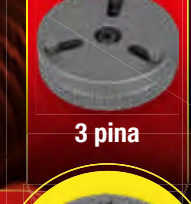

3 pina



3/8"



4 pina



17150,-



150.2440 Univerzalni alat za vraćanje kočinskih klipova-set



Ostale informacije

92390,-



5L



160.0700 Uređaj za održavanje kočnica KS5

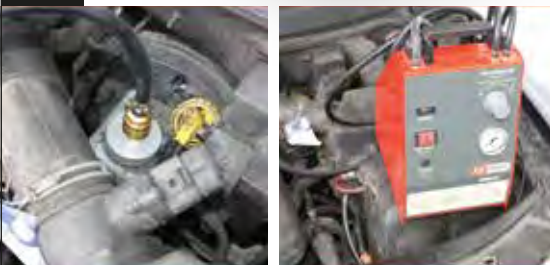

Ostale informacije

6590,-



univerzalno podesivo



Max. 70 mm

Min. 28 mm

160.0718 Univerzalni adapter za otvore za odzračivanje, podesivo



Ostale informacije

TOYOTA & LEXUS

NOVO



7,2 mm

1+2

2240,-

160.0719 Set univerzalnih odzračnih otvora za Toyotu i Lexus

i  **6**
Ostale informacije

STOP

1.200 mm

9230,-

11 mm
10 mm
9 mm
8 mm
7 mm

160.0725 Set ključeva za odzračivanje kočnica

i  **11**
Ostale informacije

KOMPLETNI

STOP

1.200 mm

9x12 mm

180 mm

11 mm
10 mm
11 mm
7 mm
11 mm
60 mm
70 mm
75 mm
85 mm

NOVO

9890,-

518.0320 Set alata za odzračivanje kočnica za VAG

i  **1**
Ostale informacije

4,75 mm (3/16")

21 mm
31 mm
41 mm
61 mm
76 mm

5270,-

120.1006 Alat za savijanje kočionih provodnika

i  **1**
Ostale informacije

4,75 mm (3/16")
6,35 mm (1/4")

3950,-

120.1004 Alat za savijanje kočionih provodnika / - alat za savijanje

① savijanje
② dupliciranje
③ nameštanje

OUT IN



Ostale informacije



3/8"



3290,-

3/8" set specijalnih profila za servisiranje ulja, za plastične zavrtnje za ispuštanje ulja, 9-delni

150.1040



Ostale informacije



9230,-

- alat za ravnanje sedišta zaptivke zavrtnja za ispuštanje ulja
- ravnanje sedišta zaptivke obezbeđuje savršenu zaptivost u oblasti zavrtnja za ispuštanje ulja
- precizno centriranje i nameštanje zaptivne površine
- set sa adapterom za originalne zavrtnje za ispuštanje ulja i zavrtnje za popravku predimenzioniranih navoja
- u stabilnom plastičnom koferu

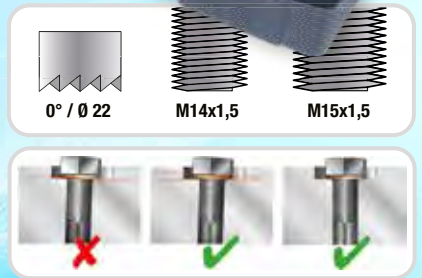

150.1485

Glodalica za ravnanje sedišta zaptivke za zavrtnj za ispuštanje ulja-set



Ostale informacije



7,5 litara

Ø 385 mm

1710,-



150.9359

Kadica za ulje 7,5 litara

i  **30**
 Ostale informacije

1/2" 21 mm
 Ø 63 - 102 mm

13190,-

3/8" set ključeva za filter za ulje

65-14, 65/67-14, 66-6, 68-14, 73-14, 74-15, 74/76-15, 75/77-15, 76-8, 76-12, 76-14, 76-30, 78-15, 80-15, 80/82-15, 86-18, 86-16, 90-15, 92-10, 93-15, 93-36, 93-45, 95-15, 96-18, 100-15, 106-15, 108-15, 108-18



i  **24**
 Ostale informacije

2,0 L

13190,-

MASTER Levak za punjenje ulja-set sa obrtnim ugonim krakom

VW Lexus Lotus Ford Nissan
 Subaru Mitsubishi Land Rover Hyundai Audi
 Chrysler Toyota Citroën Volvo Cadillac
 Citroën Buick Volvo Buick univerzalno



i  **4**
 Ostale informacije

ZA VAG

okretni ugaoni krak za teško pristupačna mesta

2,0 L

1970,-

Set levaka za punjenje ulja sa obrtnim ugonim krakom za VAG



NA PLATFORMU, POSTAVI, KRENI!

od pune gume

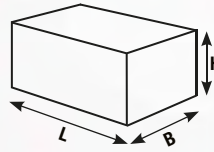

Ostale informacije

Delovi	L mm	B mm	H mm		
160.0476	1	160	120	20	650,- RSD
160.0477	1	160	120	30	920,- RSD
160.0478	1	160	120	40	1180,- RSD
160.0479	1	160	120	60	1710,- RSD
160.0480	1	160	120	80	2240,- RSD
160.0481	1	160	120	100	2760,- RSD
160.0482	1	160	120	115	3160,- RSD
160.0483	1	116.5	116,5	36,5	780,- RSD
160.0499	1	160	120	85	2370,- RSD

PE (polietilen)

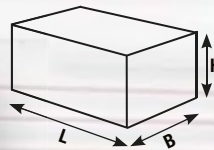

Ostale informacije

Delovi	L mm	B mm	H mm		
160.0437	1	250	150	55	1970,- RSD
160.0438	1	250	150	100	3560,- RSD
160.0486	1	340	150	55	2630,- RSD
160.0489	1	340	130	100	4220,- RSD



od pune gume sa ojačanim jezgrom

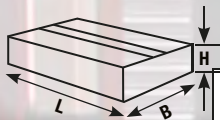

Delovi	L mm	B mm	H mm		
160.0484	1	373	100	35	5270,- RSD



Ostale informacije

od izuzetno čvrste plastike



Model 3 ✓
Model S ✓
Model X ✓
Model Y ✓



od pune gume

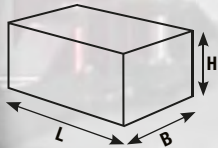

Delovi	L mm	B mm	H mm		
160.0391-TD	4	155	125	35	4610,- RSD



od pune gume

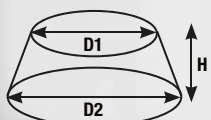

Delovi	D1 mm	D2 mm	H mm		
160.0485	1	78	105	60	1310,- RSD

160.0460 Tesla Model 3, S, X, Y

3160,-



od gume i čelične ploče

Ostale informacije

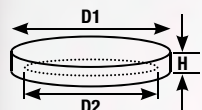

ČELIK



	D1 mm	D2 mm	H mm	Ravaglioli	Grazia	OMCN	Intertech	MAHA	Werther	Nussbaum	AMI	Twin Bush	Sirio	Space	Launch	RP Tools	J.A. Becker	ATH	HOFMANN	Hermann		
A	160.0463	120	113	22				✓														1180, RSD
B	160.0465	123	108	25	✓				✓													1180, RSD
C	160.0475	120	110	19													✓	✓	✓	✓		1180, RSD



od gume

Ostale informacije

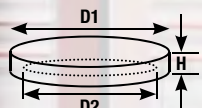

GUMA



	D1 mm	D2 mm	H mm	Ravaglioli	Grazia	OMCN	Intertech	MAHA	Werther	Nussbaum	AMI	Twin Bush	Sirio	Space	Launch	RP Tools	J.A. Becker	ATH	HOFMANN	Hermann		
A	160.0466	125	120	24						✓	✓											1580, RSD
B	160.0467	140	130	25								✓										780, RSD
C	160.0468	100	85	14	✓								✓	✓								650, RSD
D	160.0464	120	113	23				✓														650, RSD
E	160.0469	120	108	32								✓			✓	✓						1050, RSD
F	160.0470	150	130	23	✓																	650, RSD
G	160.0471	140	125	30								✓										1050, RSD
H	160.0472	130	125	14	✓									✓								920, RSD
I	160.0473	120	105	30								✓	✓	✓								920, RSD
J	160.0474	120	110	19													✓	✓	✓	✓		650, RSD
K	160.0490	100	80	21	✓													✓	✓	✓	✓	520, RSD
L	160.0491	120	108	26	✓	✓																650, RSD
M	160.0492	120	110	26	✓	✓																650, RSD
N	160.0493	145	108	24	✓																	1050, RSD
O	160.0494	145	135	26	✓																	920, RSD
P	160.0495	160	135	28			✓															920, RSD
Q	160.0496	140	103	25						✓	✓											1050, RSD
R	160.0497	150	127	25	✓																	780, RSD
S	160.0498	140	132	28																		1180, RSD

i  
Ostale informacije



1050,-

Magnetni držač za plastiku,
Ø 150 mm

800.0156



i  
Ostale informacije





330 mm

1310,-

150.2032 Metalni podizač ventila na gumama, 330 mm





i  
Ostale informacije

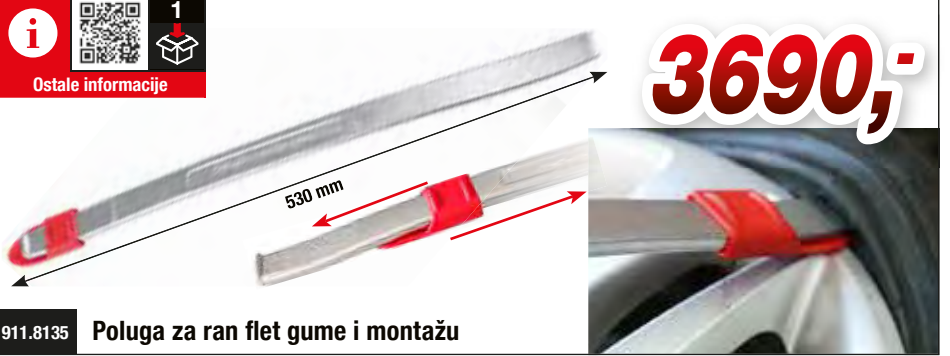

530 mm

3690,-

911.8135 Poluga za ran flet gume i montažu



i  
Ostale informacije



6590,-

800.0190 Metalni držač magneta, 390 mm



i  
Ostale informacije



600 mm

0 - 12 bar

2630,-

1/4" PT

515.1950 Merač za punjenje guma komprimiranim vazduhom



i  
Ostale informacije

KALIBRISAN



400 mm

0 - 10 bar

8180,-

1/4" PT

515.1960 Baždaren pneumatski merač vazduha u gumama



i  
Ostale informacije



7520,-

150.1070 Vulkanizerski set za gume za teretna vozila 100 mm-delni, 100 mm konac

60 x 100 mm

70 g

9 mm

OPCIONALNO
60 komada
2370,-

150.1072



- 
- 
- 
- 
- 
- 
- 

i  **1**
Ostale informacije

11870,-

Set brusilica za glavčinu točka, aluminijum, Ø 150 mm, unutrašnji Ø 90 mm

100.5080

90 mm
150 mm

OPCIONALNO

4610,-

100.5077

PRE: **POSLE:**

i  **4**
Ostale informacije

8 mm
10 mm
9 mm
8 mm

NOVO

OZ specijalan nasadni ključ-set za aluminijumske felne za višedelne OZ felne

1970,-

515.0795  

i  **3**
Ostale informacije

5270,-

1/2" set nasadnih ključeva spiralnog profila za teretna vozila, 3-delni, 17-21 mm

913.1270   17 - 19 - 21 mm

i  **2**
Ostale informacije

19,5 mm
18,5 mm
21,5 mm
20,5 mm

+

Set specijalnih snažnih nasadnih ključeva za Ford, 18,5 / 19,5 / 20,5 / 21,5 mm

3690,-

515.0895   18,5 - 19,5 - 20,5 - 21,5 mm

i  **1**
Ostale informacije

ZA MERCEDES

max. 75 Nm

2370,-

1/2" snažan torzioni produžetak, 75 Nm

515.1491 

i  **10**
Ostale informacije



Set za demontažu osigurača točka

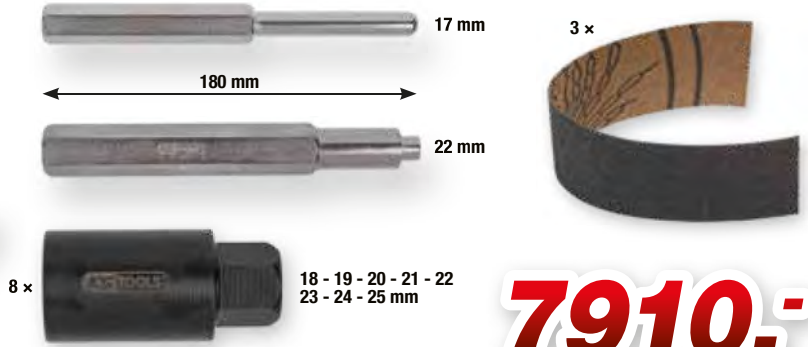

7910,-

913.1480  18 - 19 - 20 - 21 - 22 - 23 - 24 - 25 mm



i  **15**
Ostale informacije

Set alata za demontažu brave na felnama

NOVO



18470,-



913.1430

UNIVERZALNO GENIJALNO - ODGOVARA ZA SVAKI PROFIL!

IZDRŽLJIVI 1/2" SET NASADNIH KLJUČEVA ZA ALUMINIJUMSKE FELNE

1

i **3**

Ostale informacije

21 mm 19 mm 17 mm

2370,-

515.1070 1/2" 17 - 19 - 21 mm

2

i **5**

Ostale informacije

15 mm 17 mm 19 mm 21 mm 22 mm

3290,-

515.0870 1/2" 15 - 17 - 19 - 21 - 22 mm

3

i **10**

Ostale informacije

9230,-

17 mm 15 mm 19 mm 22 mm 23 mm 21 mm 17 mm 21 mm 24 mm

1/2" 15 - 17 - 19 - 21 - 22 - 23 - 24 mm

7/8" 17 mm MS21

515.0890

4

i **17**

Ostale informacije

15 mm 17 mm 19 mm 21 mm 22 mm 23 mm 24 mm 17 mm 21 mm

18470,-

KOMPLETNI SVEMOGUĆI UREĐAJ

515.0885 1/2" 15 - 17 - 19 - 21 - 22 - 23 - 24 mm 7/8" 17 mm MS21 17 - 19 - 21 mm 18,5 / 19,5 - 20,5 / 21,5 - 17,5 / 22,5 mm

	515.1072 15 mm	515.1073 17 mm	515.1075 19 mm	515.1076 21 mm	515.1077 22 mm	515.1078 23 mm	515.1079 24 mm	515.1089 Tesla 7/8"	515.2055 Mercedes 17 mm	515.2060 Hyundai KIA MS21	913.1271 Ključ za odvijanje spirala 17 mm	913.1272 Ključ za odvijanje spirala 19 mm	913.1273 Ključ za odvijanje spirala 21 mm	515.0896 Ford 18,5 / 19,5 mm	515.0897 Ford 20,5 / 21,5 mm	515.0899 Ford 17,5 / 22,5 mm	515.1134 Prođžaljak za bretna vozila, 75 mm
1	X	✓	✓	✓	X	X	X	X	X	X	X	X	X	X	X	X	X
2	✓	✓	✓	✓	✓	X	X	X	X	X	X	X	X	X	X	X	X
3	✓	✓	✓	✓	✓	✓	✓	✓	✓	✓	X	X	X	X	X	X	X
4	✓	✓	✓	✓	✓	✓	✓	✓	✓	✓	✓	✓	✓	✓	✓	✓	✓

i 1
Ostale informacije

može da se puni preko USB-C kabla (priložen)

2240,-

350 Lumena

Li-Ion 800mAh

165 mm

UV LED

sa laserskim pokazivačem

LED COB Stripe kontrolna lampa
350 lumena sa UV spot LED i laserski pokazivač

150.4400

max. 3 h 3 h IP20

i 1
Ostale informacije

140 mm

85 Lumena

1970,-

perfectLight džepna lampa
85 lumena

25 m

2 x AAA

150.4370

25 m max. 10 h IPX3

i 1
Ostale informacije

MAX. 350 Lumena

MAX. 100 Lumena

270°

OVO SE MORA IMATI!
ZA RADIONICE ILI RADOVE NAPOLJU

1970,-

Li-Ion 3,7 V 1200 mAh

Power Display

senzorski prekidač

On/Off

USB-C

senzor pokreta

XPE LED 2 stepena osvetljenja

COB LED 3 stepena osvetljenja

podešavanje veličine

95 g

max. 8 h

4,5 h

max. 10 h

IPX3

max. 3 h

3 h

6 h

8 h

4 h

8 h

Modi	COB 100%	COB 40%	COB rot	XPE 100%	XPE 40%
LED	270° 3 Watt COB LED			1 Watt High Power XPE LED	
40%	350 LM	150 LM	-	100 LM	40 LM
	3 h	6 h	8 h	4 h	8 h

On/Off

1
Ostale informacije

2370,-

360°

250 Lumena

500 Lumena

USB

ON OFF

1200 mAh litijum jonska akumulatorska baterija (priložena)

180°

3x AAA baterije (nisu sadržane u obimu isporuke)

sa USB Power Bank funkcijom

20 %	●
40 %	●●
60 %	●●●
80 %	●●●●
100 %	●●●●●

150.4510

max. 3 h

3 h

IP65

1
Ostale informacije

2630,-

130 Lumena

300 Lumena

ON OFF

USB-A OUT

USB-C IN

integrisana litijum jonska akumulatorska baterija 1.200 mAh

20 %	●
40 %	●●
60 %	●●●
80 %	●●●●
100 %	●●●●●

150.4505

max. 3 h

3 h

IP65

1
Ostale informacije

2180,-

60 Lumena

150 Lumena

Micro USB

ON OFF

360°

180°

20 %	●
40 %	●●
60 %	●●●
80 %	●●●●
100 %	●●●●●

150.4495

max. 3,5 h

2,5 h

IP20

1
Ostale informacije

4950,-

250 Lumena

550 Lumena

ON OFF

USB-A OUT

USB-C IN

integrisana litijum jonska akumulatorska baterija 1.200 mAh

20 %	●
40 %	●●
60 %	●●●
80 %	●●●●
100 %	●●●●●

150.4490

max. 3,5 h

3 h

IP65

i  **11**
 Ostale informacije



20-200 Nm

1/2"

500 mm

15830,-

Top proizvod po sertifikacionom planu
DIN EN ISO 6799
Potvrda
Preciznost
 ±1.3%

KALIBER-KONFORMITÄTSERKLÄRUNG
 Konformitätserklärung nach DIN EN ISO 6799

125 mm

10 mm 13 mm 17 mm 19 mm 21 mm 24 mm

17 mm 19 mm 21 mm

516.2400 1/2" 10 - 13 - 17 - 19 - 21 - 24 mm



i  **8**
 Ostale informacije

ZA ZAMENU GUMA U REKORDNOM VREMENU

ROBOFIT

THE DEVIL

1600 Nm

1/2"

2 x

Ø 150 mm

10 m

0 - 12 bar

NOVO

15830,-

Vaš partner:

 **4 042146 956731**
LL23-06XS DINAR

KS Tools Werkzeuge - Maschinen GmbH
 Seligenstädter Grund 10 - 12
 D-63150 Heusenstamm
 Mail: aftersales@kstools.com
 Web: www.kstools.com

HEMAЧKA - NEMACKA

515.2100

Objavlivanjem ovog prospekta sve prethodno objavljene cene prestaju da važe. Prodaja samo specijalizovanim prodavnicama. Zadržano pravo na štamparske greške, propuste i tehničke izmene. Sve cene u RSD, bez PDV-a, važe do 30.9.2024.