

TOP DEAL

KSTOOLS

WWW.KSTOOLS.COM

No Limits!

ONZE KERNCOMPETENTIE:

KWALITEIT VOOR EEN SCHERPE PRIJS!

EVOLUTION
SERIES

NIEUW



Complete
stuklijst

917.0255

1/4" + 3/8" + 1/2" + 5/16"

255 ONDERDELEN,
VOOR SLECHTS

119,90

EDELSTAHL
ROSTFREI

i **397**
Meer informatie

P₁₀

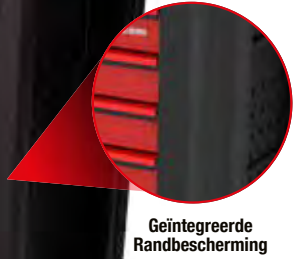
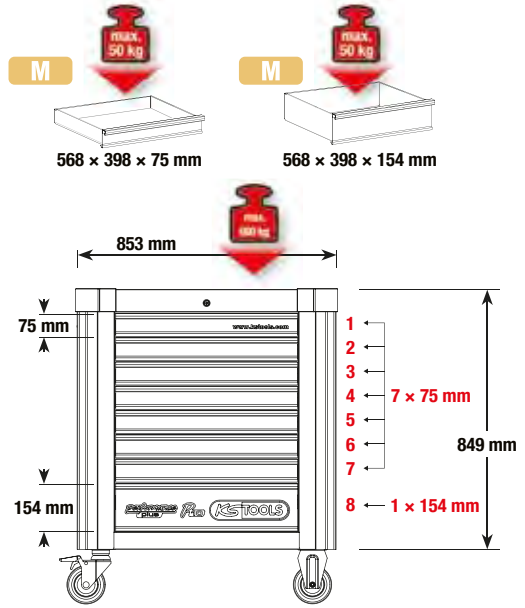

KIES UW POWER-PAKKET

810.7397

i **397**
Meer informatie

Options for the power package:

- met papierrolhouder
- met spuitbus houder
- Stabiele kogellagers
- Antistatische wielen met rem
- OPTION

P₁₅

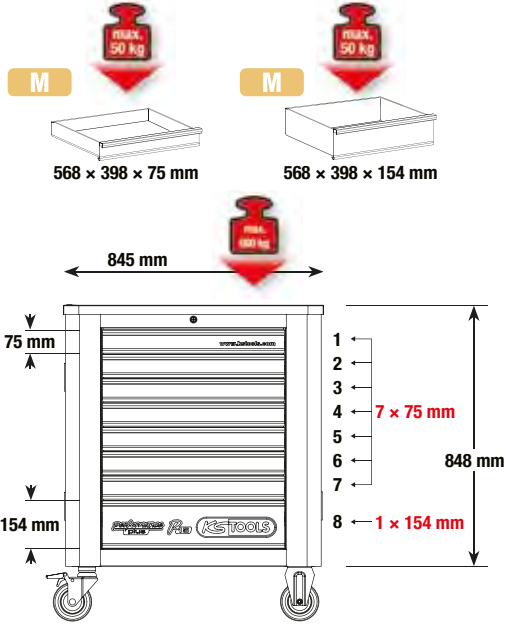

815.7397

HET PERFECTE PAKKET MET 397 ONDERDELEN

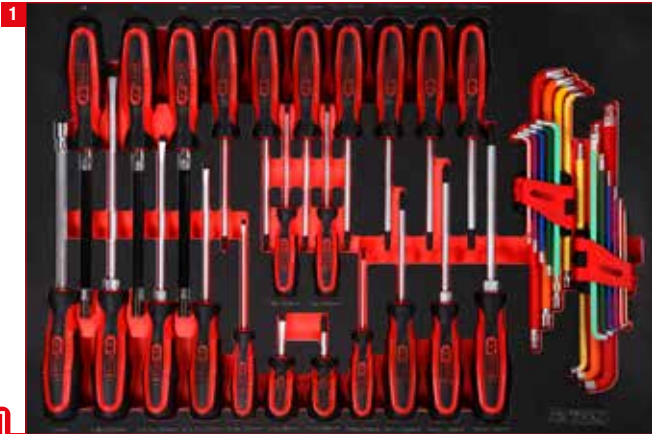

41 Schroevendraaierset



41 Sleutelset

2699,00

810.7397 P10 gereedschapwagenset met 397 gereedschappen



111 1/4" + 3/8" + 1/2" Dopsleutelset

2799,00

815.7397 P15 gereedschapwagenset met 397 gereedschappen



111 1/2" bit-doppenset



28 Tangen- en vijlenset



43 Olie- en bandenserviceset

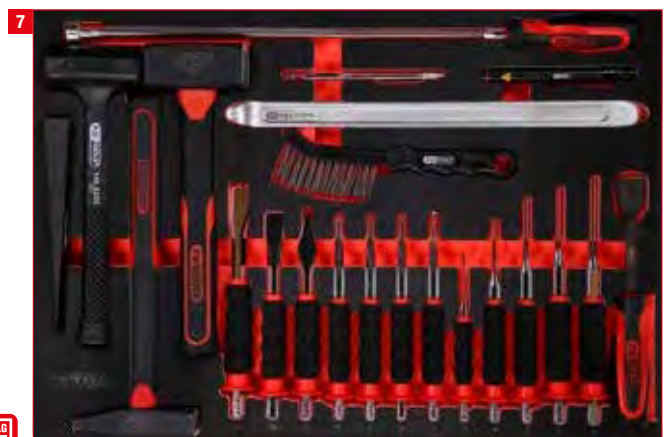

22 Hamer- en beitset

HARTELIJK WELKOM IN



Meer informatie

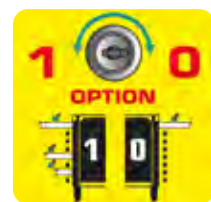

3799,00



Geïntegreerde Randbescher-
ming



met spuitbus houder



Stabiele kogellagers



Antistatische wielen met rem



Slot afsluitbaar

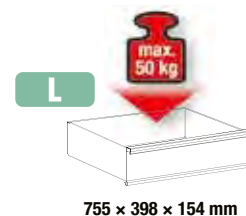
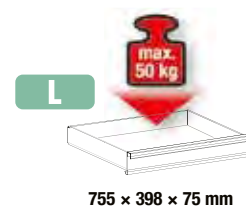
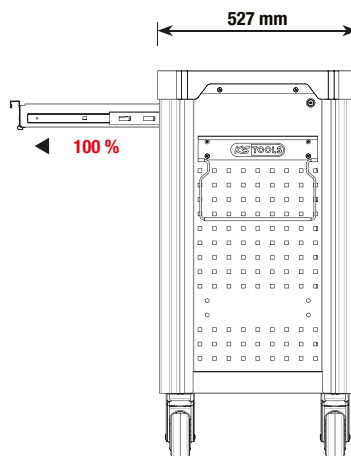
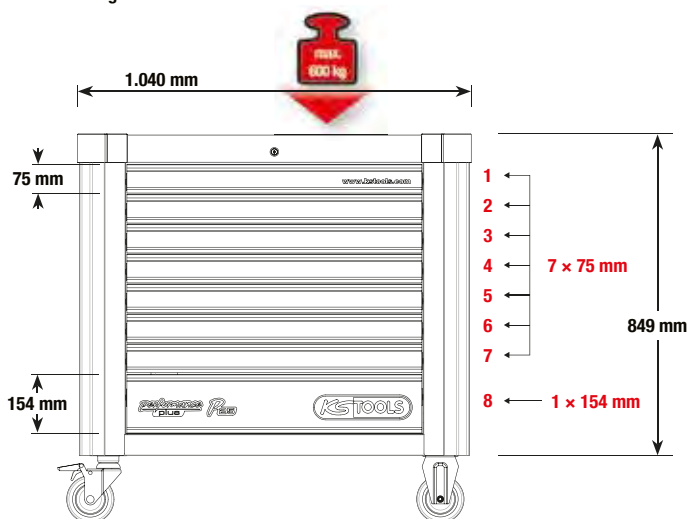

825.8564

DE KONINGSKLASSE!

Performance
plus

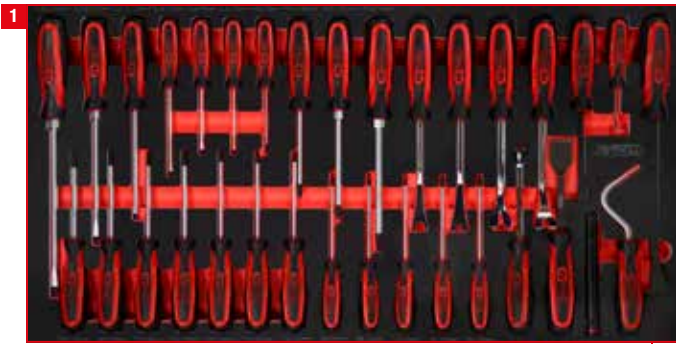

Schroevendraaierset

33



1/4" + 3/8" Dopsleutelset

213



1/2" Dopsleutelset

86



Sleutelset

57



Sleutelset

54

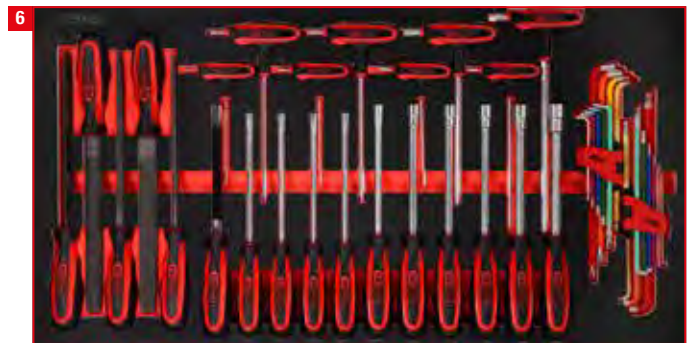

Schroevendraaijer- en vijlenset

42



Tangen- en meetgereedschapset

39



Hamer-, beitel- en kracht-doppenset

40

HOEVEEL GEREEDSCHAPSWAGENS WILL U HEBBEN?



werkblad met 10 mm dikke anti-slipmat



afsluitbaar door ingebouwd cilinderslot



Zelfsluitend en SOFT-CLOSE-functie



Vierkant gatenpatroon voor accessoires



2 x rol- en draairem
Ø wielen: 125 mm

ECO Line

449,90

ZONDER GEREEDSCHAP



max. 300 kg

max. 25 kg

i **1** 897.0007
Meer informatie

Technische gegevens:	Eco Line 897.0007	Racing Line 826.0007
Totale draagkracht:	300,0 kg	350,0 kg
Belastbaarheid per schuiflade:	25,0 kg	30,0 kg
Zelfsluitend en SOFT-CLOSE-functie:	✓	✗
Velgdiameter:	125,0 mm	125,0 mm
Wielblokkeergereedschap:	✓	✓
Met centrale vergrendeling:	✓	✓
Greepvergrendeling:	✗	✓
Hoogte:	1014,0 mm	976,0 mm
Breedte:	748 mm	788 mm
Diepte:	459,0 mm	496,0 mm
Binnenmaat schuiflade:	565 x 395 mm	565 x 395 mm
met polyurethaan hoekbescherming:	✗	✓
Vierkant gatenpatroon voor accessoires:	✓	✓
Aantal schuifladen:	7	7
plaatdikte:	0,8 mm	0,9 mm
handgreep:	✓	✓
Uittrekbare lade:	100 %	90 %
Werkplek met vakjes voor kleine onderdelen:	✗	✓
Werkblad met anti-slipmat:	✓	✗
schuifladen kogelgelagerd :	✓	✓
met metalen handgreep opzij:	✓	✓

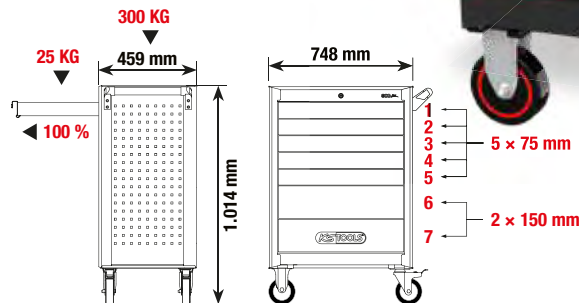

MOEITE MET KIEZEN? KIES VOOR KWALITEIT!

RACING Line



werkblad van ABS met vakken voor kleine onderdelen



afsluitbaar door ingebouwd cilinderslot



Afzonderlijke vergrendeling voorkomt ongewild openen



Vierkant gatenpatroon voor accessoires



2 x rol- en draairem
Ø wielen: 125 mm

499,90

ZONDER GEREEDSCHAP



max. 350 kg

max. 30 kg

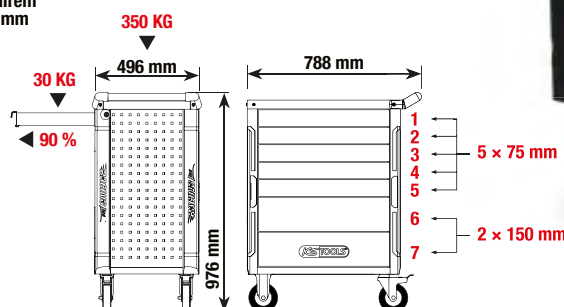

i **1** 826.0007
Meer informatie

ECO *line*

Met 7 laden en 215-dlg
Premium gereedschap

679,⁹⁰

897.7215

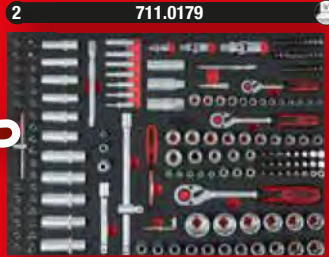

STARTPAKKET - 215 DLG



Meer informatie

RACING *line*

Met 7 laden en 215-dlg
Premium gereedschap

699,⁹⁰

826.7215



ECO *line*

Met 7 laden en 515-dlg
Premium gereedschap

879,⁹⁰

897.7515



UNIVERSEEL PAKKET - 515 DLG

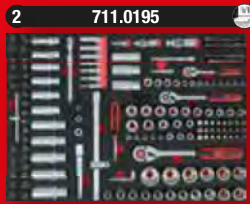
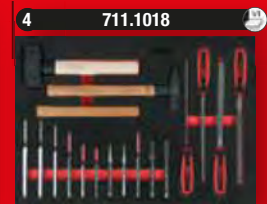
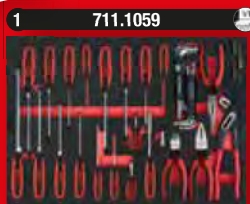

Meer informatie

RACING *line*

Met 7 laden en 515-dlg
Premium gereedschap

899,⁹⁰

826.7515



ECO *line*

Met 7 laden en 598-dlg
Premium gereedschap

1299,⁰⁰

897.7598



POWER-PAKKET - 598 DLG

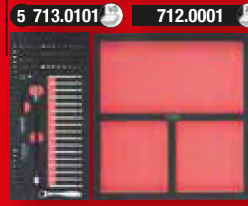
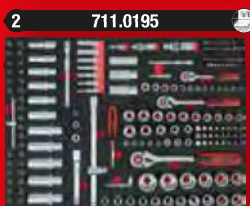
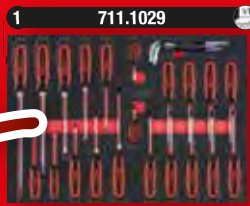

Meer informatie

RACING *line*

Met 7 laden en 598-dlg
Premium gereedschap

1349,⁰⁰

826.7598



- DIN 3110 / ISO 1085 / ISO 10102 / ISO 3318
- bekhoeck 15° gebogen
- geslepen kop
- matglans verchromd
- chroom vanadium

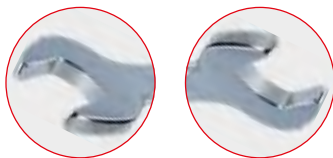

vanaf **19,90**

A	517.0148			6x7 · 8x9 · 10x11 · 12x13 14x15 · 16x17 · 18x19 20x22 mm	19,90 €
B	517.0123			6x7 · 8x9 · 10x11 · 12x13 14x15 · 16x17 · 18x19 20x22 · 21x23 · 24x27 30x32 mm	44,90 €
C	517.0125			6x7 · 8x9 · 10x11 · 12x13 14x15 · 16x17 · 18x19 20x22 · 21x23 · 24x27 25x28 · 30x32 mm	49,90 €



- FlankTraction-Profiel
- bekhoeck 15° gebogen
- ring 15° gebogen
- gepolijste koppen
- matglans verchromd



vanaf **22,90**

A	517.0048			8 · 9 · 10 · 11 · 13 · 14 17 · 19 mm	22,90 €
B	517.0052			8 · 9 · 10 · 11 · 12 · 13 · 14 15 · 16 · 17 · 18 · 19 mm	42,90 €
C	517.0043			6 · 7 · 8 · 9 · 10 · 11 · 12 13 · 14 · 15 · 16 · 17 · 18 19 · 20 · 21 · 22 · 24 · 27 30 · 32 mm	109,50 €



- 12-kant
- DIN 838 / ISO 1085 / ISO 10104 / ISO 3318
- ring 75° geknikt
- dunwandig
- gepolijste koppen



vanaf **24,90**

A	517.0248			6x7 · 8x9 · 10x11 · 12x13 14x15 · 16x17 · 18x19 20x22 mm	24,90 €
B	517.0222			6x7 · 8x9 · 10x11 · 12x13 14x15 · 16x17 · 18x19 20x22 · 21x23 · 24x27 30x32 mm	49,90 €



i **1**
Meer informatie

14,90

315 mm

22 mm

19 mm

522.1922

i **1**
Meer informatie

**DE 4-IN-1
OMKEERBARE RATEL**

10 mm

13 mm

17 mm

19 mm

19,90

72°

5°

503.4565

10 x 13 x 17 x 19 mm

i **1**
Meer informatie

HET MULTITALENT

Eenhand-multifunctionele sleutel

260 mm

8-17 mm

14-32 mm

114.0055

8-9-10-11-12-13-14-15-16-17-18-19-20-21-22-23-24-25-26-27-28-29-30-31-32 mm

33,90

i **12**
Meer informatie

72°

5°

119,90

503.4665

8-9-10-11-12-13-14-15-16-17-18-19 mm

i **30**
Meer informatie

DE ALLESKUNNER

5/16" x 13 mm

1/2"

10 mm x 13 mm

3/8"

1/4" x 10 mm

1/4"

12 x

12 x

168,90

503.4960

8-9-10-11-12-13-14-15-16-17-18-19 mm

i **2**
Meer informatie

72 5°

1/2" 305 - 445 mm

1/4" 173 - 223 mm

VERSTELBAAR:
1/4" IN 4 NIVEAUS
1/2" IN 6 NIVEAUS

NIEUW **34,90**

914.1412

i **1**
Meer informatie

NIEUW 600 MM!

72 5°

1/2" 460 - 600 mm

fase: 1 2 3 4 5 6

24,90

VERSTELBAAR IN 6 STANDEN

914.1205

i **1**
Meer informatie

49,90

760 mm

**MAXIMALE FLEXIBILITEIT,
OPTIMALE CONTROLE**

1/2"

918.1293

72 5°

**CONSISTENTE KRACHT -
INNOVATIEVE FUNCTIE**

A 1/4" 102 Nm 140 mm **24,90 €**

B 3/8" 325 Nm 190 mm **29,90 €**

C 1/2" 710 Nm 245 mm **36,50 €**

vanaf 24,90

102 Nm

710 Nm

72 5°

54,90

920.0002 **i** **2**
Meer informatie

			Nm	↔	
A	920.1490		102	140 mm	24,90 €
B	920.3890		325	190 mm	29,90 €
C	920.1290		710	245 mm	36,50 €

DE BESTEN DIE WIJ OOIIT GEBOUWD HEBBEN!

Wij weten wat we kunnen. En omdat wij exact weten hoe goed ons Monster-ratel-assortiment is, is het voor ons vanzelfsprekend dat wij u garantie geven op elk model. Niet 2 of 3 jaar. Nee, tot wel 10 jaar! Zo is de garantie net zo premium als onze Monster-ratels!



1 **80°** **4,5°** **1/4"** **29,90** **i** **1**
Meer informatie

935.1490 **1/4"** **106 g** **125 mm** **>110 Nm**



2 **80°** **4,5°** **1/4"** **29,90** **i** **1**
Meer informatie

935.1495 **1/4"** **106 g** **125 mm** **>100 Nm**

3 **96°** **3,75°** **3/8"** **39,90** **i** **1**
Meer informatie

935.3890 **3/8"** **227 g** **199 mm** **>365 Nm**



**GEGARANDEERD:
6 MONSTERS
VOOR HET LEVEN!**

4 **100°** **3,6°** **1/2"** **49,90** **i** **1**
Meer informatie

935.1290 **1/2"** **567 g** **275 mm** **>950 Nm**

5 **100°** **3,6°** **1/2"** **69,90** **i** **1**
Meer informatie

935.1295 **1/2"** **757 g** **425 mm** **>950 Nm**

6 **100°** **3,6°** **1/2"** **99,90** **i** **1**
Meer informatie

TELESCOPISCH

406 431 457 482 508 533 557 582 607 635 mm **>950 Nm**

935.1285 **1/2"** **1.280 g** **406 - 635 mm**

-15% **NEUW** **100°** **3,6°** **1/2"** **>950 Nm** **80°** **4,5°** **1/4"** **>110 Nm** **i** **2**
Meer informatie

935.0002 **69,90**



Bit-dopset voor inbusschroeven, kort

Meer informatie

3/8"

4 mm 5 mm 6 mm 7 mm 8 mm 9 mm 10 mm 12 mm 14 mm



NIEUW

34,90

917.4000 4 - 5 - 6 - 7 - 8 - 9 - 10 - 12 - 14 mm

IK WIL GRAAG. MAAR KORT!



Bit-dopset voor Torx®-schroeven, kort

Meer informatie

3/8"

T10 T15 T20 T25 T27 T30 T40 T45 T50 T55

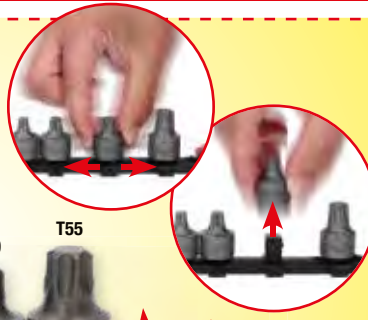

NIEUW

39,90

917.4015 T10 - T15 - T20 - T25 - T27 - T30 - T40 - T45 - T50 - T55

TORX TOTAAL: ALLES IN ÉÉN KOFFER



Meer informatie

5 x		1/4": E4 - E5 - E6 - E7 - E8
4 x		3/8": E10 - E12 - E14 - E16
4 x		1/2": E18 - E20 - E22 - E24
5 x		1/4": EPL4 - EPL5 - EPL6 - EPL7 - EPL8
4 x		3/8": EPL10 - EPL12 - EPL14 - EPL16
4 x		1/2": EPL18 - EPL20 - EPL22 - EPL24
8 x		1/4": T6 - T8 - T10 - T15 - T20 - T25 - T27 - T30
5 x		3/8": T40 - T45 - T47 - T50 - T55
2 x		1/2": T60 - T70
7 x		1/4": TB8 - TB10 - TB15 - TB20 - TB25 - TB27 - TB30
4 x		3/8": TB40 - TB45 - T50 - T55
1 x		1/2": TB60
7 x		1/4": IP8 - IP10 - IP15 - IP20 - IP25 - IP27 - IP30
3 x		3/8": IP40 - IP45 - IP50
2 x		1/2": IP55 - IP60
7 x		1/4": IPR8 - IPR10 - IPR15 - IPR20 - IPR25 - IPR27 - IPR30
3 x		3/8": IPR40 - IPR45 - IPR50
2 x		1/2": IPR55 - IPR60

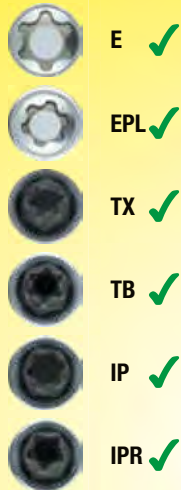

99,90

NIEUW



EVOLUTION SERIES

1/4" + 3/8" + 1/2"



i **30**
Meer informatie

EVOLUTION SERIES

NIEUW

79,90

1/2"

911.4510

STAINLESS STEEL

55 mm	●	5 - 6 - 7 - 8 - 10 - 12 - 14 - 17 - 19 mm
100 mm	●	5 - 6 - 7 - 8 - 10 - 11 - 12 - 13 mm
140 mm	●	5 - 6 - 7 - 8 - 10 - 12 - 14 mm
200 mm	●	5 - 6 - 7 - 8 - 10 - 12 mm

i **32**
Meer informatie

EVOLUTION SERIES

NIEUW

79,90

1/2"

911.4520

STAINLESS STEEL

55 mm	★	M5 - M6 - M7 - M8 - M9 - M10 - M12 - M13 - M14
100 mm	★	M5 - M6 - M7 - M8 - M9 - M10 - M12 - M13 - M14
140 mm	★	M7 - M8 - M9 - M10 - M12 - M13 - M14
200 mm	★	M7 - M8 - M9 - M10 - M12 - M13 - M14

i **26**
Meer informatie

EVOLUTION SERIES

NIEUW

79,90

1/2"

911.4540

STAINLESS STEEL

55 mm	●	M5 - M6 - M8 - M9 - M10 - M12 - M14 - M16
100 mm	●	M5 - M6 - M8 - M9 - M10 - M12 - M14
140 mm	●	M5 - M6 - M8 - M9 - M10 - M12 - M14
200 mm	●	M8 - M10 - M12 - M14

i **32**
Meer informatie

EVOLUTION SERIES

NIEUW

79,90

1/2"

911.4550

STAINLESS STEEL

55 mm	★	T20 - T25 - T27 - T30 - T40 - T45 - T50 - T55 - T60 - T70
100 mm	★	T20 - T25 - T27 - T30 - T40 - T45 - T50 - T55 - T60 - T70
140 mm	★	T40 - T45 - T50 - T55 - T60 - T70
200 mm	★	T40 - T45 - T50 - T55 - T60 - T70

A matglans verchromd **B** hoogglans verchromd

vanaf 27,90

vernikkeld

A	917.0648		48	27,90 €	1/4"	
B	918.0648		48	29,90 €	 	4 - 4,5 - 5 - 5,5 - 6 - 7 - 8 - 9 10 - 11 - 12 - 13 - 14 mm

i 20
Meer informatie

A matglans verchromd

59,90

vernikkeld

A	911.0620		20	59,90 €	1/2"	 	10 - 11 - 12 - 13 - 14 - 15 16 - 17 - 18 - 19 - 22 - 24 27 - 30 - 32 mm
----------	----------	--	----	---------	------	------	---

A matglans verchromd **B** hoogglans verchromd

vanaf 79,90

vernikkeld

A	911.0694		94	79,90 €	1/4" + 1/2"	
B	918.0694		94	89,90 €	 	4 - 4,5 - 5 - 5,5 - 6 - 7 - 8 - 9 10 - 11 - 12 - 13 - 14 - 15 - 16 17 - 18 - 19 - 20 - 21 - 22 - 23 24 - 27 - 30 - 32 mm

i 108
Meer informatie

A matglans verchromd

89,90

vernikkeld

A	911.0708		108	89,90 €	1/4" + 1/2"	 	4 - 4,5 - 5 - 5,5 - 6 - 7 - 8 - 9 10 - 11 - 12 - 13 - 14 - 15 - 16 17 - 18 - 19 - 20 - 21 - 22 - 24 27 - 30 - 32 mm
----------	----------	--	-----	---------	-------------	------	--



179



Meer informatie

1/4"		4 - 4,5 - 5 - 5,5 - 6 - 7 - 8 - 9 - 10 - 11 - 12 13 - 14 mm
1/4"		4 - 5 - 6 - 7 - 8 - 9 - 10 mm
		E4 - E5 - E6 - E7 - E8
3/8"		10 - 11 - 12 - 13 - 14 - 15 - 16 - 17 - 18 19 mm
3/8"		10 - 11 - 12 - 13 - 14 - 15 mm
		E10 - E11 - E12 - E14 - E16 - E1
1/2"		10 - 11 - 12 - 13 - 14 - 15 - 16 - 17 - 18 19 - 20 - 21 - 22 - 24 - 27 - 30 - 32 mm
1/2"		16 - 17 - 18 - 19 - 22 mm
		E20 - E24
1/4"		
5/16"		
1/4" - 3/8"		50 - 100 - 125 - 150 - 250 mm
1/2"		1,3 - 1,5 - 2 - 2,5 - 3 - 4 - 5 mm
1/4" - 3/8"		
1/2"		
1/4" - 3/8"		1/4" - 5/16"
1/2"		
1/4"		

1/4" + 3/8" + 1/2"

vernikkeld

matglans
verchromd

94,90

1/4"		4 - 4,5 - 5 - 5,5 - 6 - 7 - 8 - 9 - 10 - 11 12 - 13 - 14 mm
1/4"		6 - 7 - 8 - 9 - 10 - 11 - 12 - 13 - 14 15 mm
3/8"		10 - 11 - 12 - 13 - 14 - 15 - 16 - 17 - 18 19 mm
3/8"		10 - 11 - 12 - 13 - 14 - 15 mm
1/2"		10 - 11 - 12 - 13 - 14 - 15 - 17 - 18 - 19 20 - 21 - 22 - 24 - 27 - 30 - 32 mm
1/2"		17 - 19 - 22 mm
1/4"		
5/16"		
12 x		8 - 9 - 10 - 11 - 12 - 13 - 14 - 15 - 16 17 - 18 - 19 mm
		1,3 - 1,5 - 2 - 2,5 - 3 - 4 - 5 mm
1/4" - 3/8"		
1/2"		
1/4"		

A

matglans
verchromd

B

hoogglans
verchromd

A

917.0216



216

174,90 €

vernikkeld

B

918.0216



216

189,90 €

1/4" + 3/8" + 1/2"

A

vanaf
174,90



A	911.0721			21		19 · 21 · 22 · 23 · 24 · 26 · 27 · 29 · 30 32 · 35 · 36 · 38 · 41 · 46 · 50 mm	219, ⁹⁰ €
B	911.0722			21		19 · 21 · 22 · 23 · 24 · 26 · 27 · 29 · 30 32 · 35 · 36 · 38 · 41 · 46 · 50 mm	248, ⁵⁰ €
C	911.0751			21		3/4" · 13/16" · 7/8" · 15/16" · 1" 1.1/16" · 1.1/8" · 1.3/16" · 1.1/4" 1.5/16" · 1.3/8" · 1.7/16" · 1.1/2" 1.5/8" · 1.3/4" · 2"	248, ⁵⁰ €

vanaf
219,⁹⁰

			82
Meer informatie			
1/4"			4 - 4,5 - 5 - 5,5 - 6 - 7 - 8 - 9 - 10 - 11 12 - 13 - 14 mm
1/2"			14 - 15 - 16 - 17 - 18 - 19 - 20 - 21 - 22 24 - 27 - 30 - 32 mm
1/4"			16 - 21 mm
1/4"			
5/16"			
1/4"			
1/2"			
1/4"			150 mm
1/4"			50 - 100 - 125 - 250 mm
1/2"			
1/4"			150 mm
12 x			8 - 10 - 11 - 12 - 13 - 14 - 17 - 19 - 22 mm



129,⁹⁰

911.0682 **1/4" + 1/2"**

matglans
verchromd

vernikkeld

i  **47**
Meer informatie



1/2"		10 - 11 - 12 - 13 - 14 - 15 - 16 - 17 18 - 19 - 20 - 21 - 22 - 24 mm
3 x		16 - 18 - 21 mm
14 x		6 - 7 - 8 - 9 - 10 - 11 - 12 - 13 - 14 15 - 16 - 17 - 18 - 19 mm
1 x		250 mm
2 x		125 - 250 mm
1 x		1/2"
5 x		3 - 5,5 - 8 mm + PH1 - PH2
1 x		T8 - T10 - T15 - T20 - T25 - T27 T30 - T40
1 x		2,5 - 3 - 4 - 5 - 6 - 7 - 8 - 10 mm
1 x		3 - 48 V
1 x		240 mm
1 x		180 mm
1 x		300 g















149,90

1/2"

matglans
verchromd

940.0047 

1/4"		4 - 4,5 - 5 - 5,5 - 6 - 7 - 8 - 9 - 10 11 - 12 - 13 mm
1/2"		10 - 11 - 12 - 13 - 14 - 15 - 16 - 17 19 - 20 - 21 - 22 - 24 - 27 - 30 - 32 mm
12 x		8 - 9 - 10 - 11 - 12 - 13 - 14 - 15 - 16 17 - 18 - 19 mm
2 x		1/4": 100 mm / 1/2": 125 mm
1 x		1/4" / 1/2"
7 x		3 - 4 - 5,5 - 6,5 mm + PH0 - PH1 - PH2
1 x		T8 - T10 - T15 - T20 - T25 - T27 - T30 T40 - T45 - T50
1 x		1,5 - 2 - 2,5 - 3 - 4 - 5 - 6 - 8 - 10 mm
1 x		
1 x		300 g
1 x		160 mm
1 x		200 mm



1/4" + 1/2"

A matglans
verchromd

B hoogglans
verchromd

A

917.0797



97 174,90 €

B

918.0797



97 189,90 €



vanaf
174,90

i **88**
Meer informatie

1/4"		4 - 4,5 - 5 - 5,5 - 6 - 7 - 8 - 9 - 10 - 11 12 - 13 mm
1/2"		14 - 15 - 16 - 17 - 18 - 19 - 20 - 21 - 22 23 - 24 - 25 - 26 - 27 - 28 30 - 32 mm
12 x		6 - 7 - 8 - 9 - 10 - 11 - 12 - 13 - 14 17 - 19 - 22 mm
3 x		1/4": 50 - 100 mm / 1/2": 125 mm
1 x		1/4"
4 x		⊖ 6,5 - 8 mm ⊕ PH1 - PH2
1 x		1/4"
1 x		1/4" ⊖ ⊕ * ● ☆
1 x		150 - 250 V
1 x		250 mm
1 x		180 mm
1 x		300 g

189,90

matglans
verchroomd

911.0688

1/4" + 1/2"

i **127**
Meer informatie

DE ALLESKUNNER

1

4 x

⊖ ⊕

2

8 x

8 - 9 - 10 - 11 - 13
14 - 17 - 19 mm

3

4

4 - 4,5 - 5 - 5,5 - 6 - 7
8 - 9 - 10 - 11 - 12
13 - 14 mm

1/4"

⊕ * ☆

⊖ ●

1/2"

10 - 13 - 14 - 16 - 17
18 - 19 - 20 - 22 - 24
27 - 30 - 32 mm

369,90



911.0727

1/4" + 1/2"

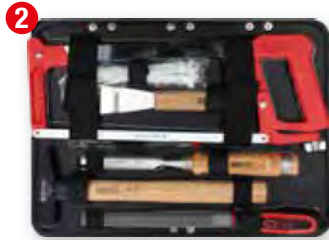
i  **149**
Meer informatie



389,90

1/4"		4 - 4,5 - 5 - 5,5 - 6 - 7 8 - 9 - 10 - 11 - 12 13 mm
1/2"		10 - 13 - 14 - 15 - 16 17 - 18 - 19 - 21 - 22 24 - 27 - 30 - 32 mm
10 x		8 - 10 - 11 - 12 - 13 14 - 15 - 17 - 19 - 22 mm





911.0649 **1/4" + 1/2"**

**VOLLEDIGE UITRUSTING?
SLA DAN HIER UW SLAG!**

i  **130**
Meer informatie



449,90

1/4"		4 - 4,5 - 5 - 5,5 - 6 - 7 8 - 9 - 10 - 11 - 12 13 mm
1/2"		10 - 11 - 12 - 13 - 14 15 - 16 - 17 - 18 - 19 21 - 22 - 24 - 27 - 30 32 mm
11 x		8 - 9 - 10 - 11 - 12 13 - 14 - 16 - 17 - 19 22 mm



911.0630 **1/4" + 1/2"**

i  128 
Meer informatie

VOOR ELEKTROMONTEURS 1

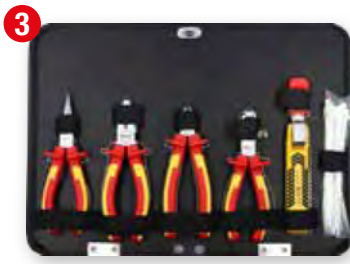

4 x   

1/4"  4 - 4,5 - 5 - 5,5 - 6 - 7 - 8
9 - 10 - 11 - 12 - 13 mm

1/2"  10 - 11 - 12 - 13 - 14 - 15
16 - 17 - 18 - 19 - 21 - 22 mm

10 x  8 - 10 - 11 - 12 - 13 - 14
15 - 17 - 19 - 22 mm

389,90

911.0628

1/4" + 1/2"

i  127 
Meer informatie

DE ALLROUNDER



1/4"  4 - 5 - 6 - 7 - 8 - 9 - 11
12 - 13 mm

1/2"  10 - 11 - 12 - 13 - 14 - 15 - 16
17 - 18 - 19 - 21 - 22 - 24 mm

10 x  8 - 9 - 10 - 11 - 12 - 13
14 - 16 - 17 - 18 - 19 mm

519,90

911.0735

1/4" + 1/2"



99

Meer informatie

DE SCHATKISTEN!



99

Meer informatie



2

	4 - 5 - 6 - 7 - 8 - 9 - 10 - 11 - 12 13 - 14 mm
	13 - 15 - 17 - 18 - 19 - 20 - 21 - 22 24 - 27 - 30 - 32 mm



1



2



RATELRING-STEEKSLEUTEL

RINGSTEEKSLEUTEL

U KUNT KIEZEN!

8 - 9 - 10 - 11 - 12 - 13 - 14 - 15 - 16 - 17 - 18 - 19 mm

8 - 9 - 10 - 11 - 12 - 13 - 14 - 15 - 16 - 17 - 18 - 19 mm



599,90

519,90

1/4" 1/2"

1/4" 1/2"



918.0100

918.0200



40

Meer informatie

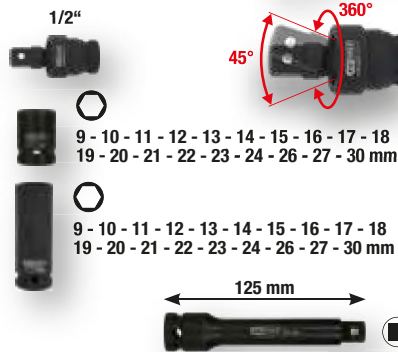

114,90



515.0065

1/2"





Meer informatie





vanaf

99,90



Schaalverdeling met loop

Micrometerschaalverdeling



met Keurmerk
DIN EN ISO 6789
Certificaat
Nauwkeurigheid

		Nm	Verdeling Nm	Lbf-ft		
516.1402		1/4"	1-5	0,10	0,8 - 3,6	99,90 €
516.1412		1/4"	5-25	0,10	0,8 - 18	99,90 €
516.1422		3/8"	10-50	0,25	4 - 37	99,90 €
516.1432		1/2"	20-100	0,50	8 - 75	110,90 €
516.1442		1/2"	40-200	1,00	15 - 150	110,90 €
516.1472		1/2"	60-320	1,00	45 - 236	124,90 €
516.1482		1/2"	80-420	1,00	60 - 310	135,90 €
516.1493		3/4"	150-750	10,00	150 - 550	588,90 €
516.1495		1"	200-1000	20,00	220 - 730	673,90 €





Meer informatie

3 IN 1



LANG

9,90



A	151.2100			8	2 - 2,5 - 3 - 4 - 5 - 6 8 - 10 mm	9,90 €
B	151.2300			8	T10 - T15 - T20 - T25 T30 - T40 - T45 - T50	9,90 €





Meer informatie

22



LANG

12,90



**DE BELANGRIJKSTE
22 IN ÉÉN SET**

151.4000

i **32**
Meer informatie

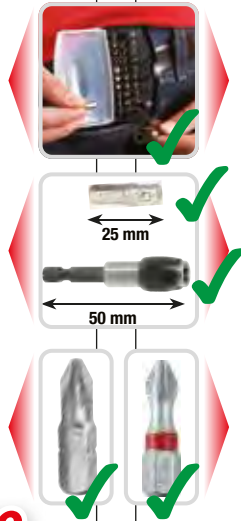

i **32**
Meer informatie

TORQION power

+30%



- 1 x 1/4"
- 1 x 1/4"
- 3 x PH1 - PH2 - PH3
- 6 x 2 x PZ1 - 2 x PZ2 - 2 x PZ3
- 3 x 5,5 - 6,5 - 8 mm
- 3 x 4 - 5 - 6 mm
- 15 x 2 x TB10 - 3 x TB15 - 2 x TB20
3 x TB25 - 3 x TB30 - 2 x TB40

911.2060

8,90

911.3030

9,90

- 1 x 1/4"
- 1 x 1/4"
- 4 x 3 - 4 - 5 - 6 mm
- 4 x PH1 - 2 x PH2 - PH3
- 4 x PZ1 - 2 x PZ2 - PZ3
- 4 x 3 - 4 - 5 - 6 mm
- 7 x T10 - T15 - T20 - T25 - T27 - T30 - T40
- 7 x TB10 - TB15 - TB20 - TB25 - TB27 - TB30 - TB40

i **108**
Meer informatie

TORQION power

- 25 mm 6x: 4 - 5 - 6 mm
- 6x: 4 - 5 - 6 mm
- 6x: PH1 - PH2 - PH3
- 6x: PZ1 - PZ2 - PZ3
- 6x: T10 - T15 - T20 - T25 - T30 - T40

29,90



918.3108

1/4"

108 BITS, DIE HET VERSCHIL MAKEN

i **32**
Meer informatie



- 4 x 3 - 4 - 5 - 6 mm
- 4 x PH1 - 2 x PH2 - PH3
- 4 x PZ1 - 2 x PZ2 - PZ3
- 4 x 3 - 4 - 5 - 6 mm
- 7 x T10 - T15 - T20 - T25
T27 - T30 - T40
- 7 x TB10 - TB15 - TB20 - TB25
TB27 - TB30 - TB40



44,90

918.3010

1/4"

i **31**
Meer informatie



TORQION power



- 2 x 4 - 5 mm
- 3 x PH1 - PH2 - PH3
- 3 x PZ1 - PZ2 - PZ3
- 9 x 1,5 - 2 - 2,5 - 3 - 4 - 5 - 6
7 - 8 mm
- 11 x T6 - T7 - T8 - T9 - T10 - T15
T20 - T25 - T27 - T30 - T40

57,90

918.3015

1/4"

i **24**
Meer informatie

KLEIN & FIJN

25 mm
vermikkeld

19,90

1 x		1/4": 92 mm
1 x		1/4": 50 mm
1 x		1/4"
6 x		6 - 7 - 8 - 10 - 11 - 13 mm
2 x		PH1 - PH2
2 x		PZ1 - PZ2
2 x		4,5 - 5,5 mm
4 x		3 - 4 - 5 - 6 mm
5 x		TB10 - TB15 - TB20 - TB25 - TB30

911.2010 **1/4"**

i **208**
Meer informatie

39,90

DE ALLES-SCHROEVER!

1/4"		1/4": 205 mm
138 x		25 mm
29 x		50 mm
18 x		75 mm
20 x		4 - 5 - 6 - 7 - 8 - 9 - 10 - 11 - 12 - 13 mm 5/32" - 3/16" - 7/32" - 1/4" - 9/32" 5/16" - 11/32" - 3/8" - 7/16" - 1/2"
1 x		1/4": 50 mm
1 x		1/4"

911.2008 **1/4"**

i **7**
Meer informatie

HET KLEINE WONDER DER TECHNIEK!

9,90

6 IN ONE

110 mm

1/4"

36

NIEUW

- 4 - 5 mm
- PH1 - PH2
- PZ1 - PZ2

159.2025 **6 in 1 Mini-ratel-schroevendraaier**

i **13**
Meer informatie

14,90

240 mm

12 IN ONE

- 4 - 5 - 6 mm
- PH1 - PH2 - PH3
- 3 - 4 - 5 mm
- T15 - T20 - T25

1/4"

159.2035 **12-in-1 ratel-bit-schroevendraaier**

1
Meer informatie

2 IN 1

1/4" **8,90**

85 mm

OF

514.1126

1
Meer informatie

1/4" **10,90**

MET GEWRICHT

90 mm

20°

514.1136

21
Meer informatie

4 mm

30 mm 165 mm

Ø 16 mm

1 - 1,3 - 1,5 - 2 - 2,5 - 3 mm

PH00 - PH0 - PH1 - PH2

1,5 - 2 - 2,5 - 3 - 3,5 mm

T3 - T4 - T5 - T6 - T7

39,90

500.7195

27
Meer informatie

LED

1/4"

eMONSTER

EENMAAL AANGERAAKT, VOOR ALTIJD VERKOCHT.

34,90

515.3600

4x		3,0 - 4,0 - 5,0 - 6,0 mm
4x		3,0 - 4,0 - 5,0 - 6,0 mm
5x		PH0 - PH1 - PH2 - PH3
4x		PZ0 - PZ1 - PZ2 - PZ3
4x		T10 - T15 - T20 - T25
4x		#0 - #1 - #2 - #3
1x		PH1
1x		50 mm
1x		Max. 6 Nm

max 6 Nm

max 4 Nm

max 2 Nm

3,6 V

1.500 mAh

300 rpm

USB-C

2+ LED



51



Meer informatie

DE ALLROUNDER



1 Boren



2 Reinigen



3 Slijpen



23x



4 Graveren

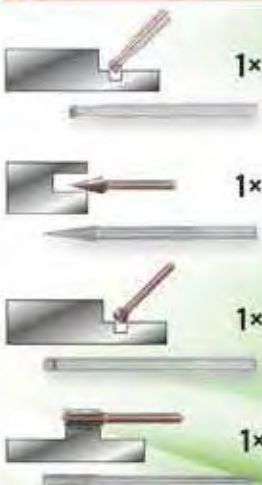

5 Snijden



6 Polijsten



eMONSTER
Accu-multitoolset
met 50 accessoires



eMONSTER



49,90

515.3990



50



Meer informatie

OM LATER TE KOPEN



Accessoireset, 50-dlg

9,90

515.3992

DE TRANSFORMER ONDER DE SCHROEFMACHINES



eMONSTER

Een hoog toerental van 210 omw/min, hierdoor 5x sneller dan het handmatig aanhalen

Praktische batterij laadniveau-indicator met 3 LED's

Versterkte overbrenging



2 in 1 gereedschap met een goede balans tussen kracht en grootte, ideaal voor het werken boven het hoofd en op krappe plaatsen.

Magnetische bitopname



Koppelvoorkeuze in 10 stappen instelbaar



Verbeterd gripcomfort



1.3 Ah accu met een gebruiksduur voor 1000+ schroeven

De li-ion-accu met een hoge capaciteit is, dankzij de USB-C aansluiting, ook snel weer opgeladen en klaar voor gebruik.

Geïntegreerde lamp



Het doordraaien van de schroeven wordt voorkomen door automatische vergrendeling van de motor wanneer het koppel wordt overschreden.



Meer informatie

Incl. 25 bits



39,90

515.6500

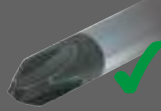

verchromd en
punt gebruineerd



Met profielmarkering op
de greep

i **5**
Meer informatie

159.0005

9,90

PH1 PH2 6,5 mm 5,5 mm 4 mm

i **6**
Meer informatie

159.0030

19,90

T10 T15 T20 T25 T30 T40

i **6**
Meer informatie

159.0040

19,90

TB10 TB15 TB20 TB25 TB30 TB40

i **39**
Meer informatie

50,90

6 x		3 - 4 - 5,5 - 6,5 8 - 10 mm	7 x		2 - 2,5 - 3 - 4 - 5 6 - 8 mm
5 x		PH0 - PH1 - PH2 PH3 - PH4	7 x		TB10 - TB15 - TB20 TB25 - TB27 - TB30 TB40
4 x		PZ0 - PZ1 - PZ2 PZ3	7 x		T10 - T15 - T20 T25 - T27 - T30 T40
1 x		6 mm	1 x		1/4"
1 x		PH2	1 x		205 mm

159.0100 **1/4"**

i **13**
Meer informatie

**DIE KAN WEL
TEGEN EEN
STOOTJE!**

67,90

doorlopende kling

5 x		3,5 - 5,5 - 7 - 8 - 10 mm
5 x		PH0 - PH1 - PH2 - PH3 - PH4
1 x		6 mm
1 x		PH2
1 x		1/4"

151.1150 **1/4"**

i  **15**
Meer informatie

260 mm



A

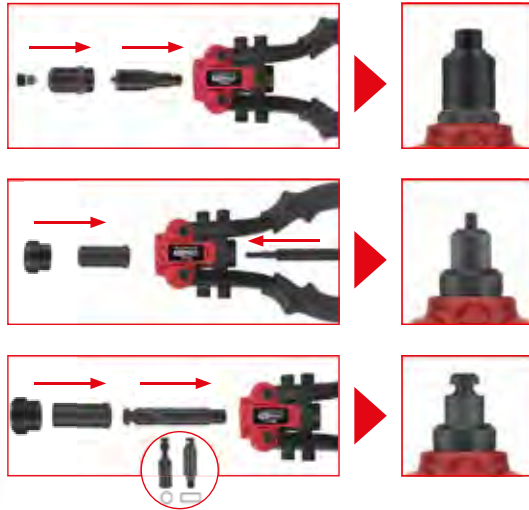

67,90

150.9805



Klinknagel (aluminium)

Klinknagel (staal)

Moer

		A	B
		150.9805	150.9630
	in koffer	✓	✓
	lengte mm	260	510
	knabfelschaar	✓	✗
	bediening met één of twee handen		
	M10	✓	✓
	M8	✓	✓
	M6	✓	✓
	M5	✓	✓
	M4	✓	✓
	M3	✓	✓
	Staal 4,8 mm	✓	✓
	Staal 4,0 mm	✓	✓
	Staal 3,2 mm	✓	✓
	Staal 2,4 mm	✓	✓
	Aluminium 6,4 mm	✓	✓
	Aluminium 4,8 mm	✓	✓
	Aluminium 4,0 mm	✓	✓
	Aluminium 3,2 mm	✓	✓
	Aluminium 2,4 mm	✓	✓

i  **17**
Meer informatie



B

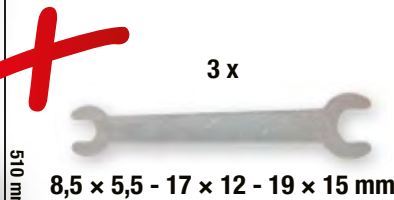

3 x 8,5 x 5,5 - 17 x 12 - 19 x 15 mm



5 x M4 - M5 - M6 - M8 - M10



6 mm

174,90

150.9630







Meer informatie







vanaf 10,90



	↔	↔	
115.2011	175 mm	7"	10,90 €
115.2010	240 mm	10"	12,90 €
115.2012	300 mm	12"	15,90 €
115.2016	415 mm	16"	31,90 €

Meer informatie



PREMIUM KWALITEIT!

Meer informatie



A 19 - 60 mm



B 40 - 100 mm

vanaf 110,90

	↺ ↻	↔	
A	119.2055	19 - 60 mm	160 mm
B	119.2060	40 - 100 mm	230 mm





Meer informatie

SAFETY FIRST



60 - 100 mm



40 - 85 mm

49,90







0° 15° 45° 90°
90° 45° 15° 0°





Meer informatie

500.1350 **Borgringtangenset met vergrendeling**

BRILJANTE PRECISIEGEREEDSCHAPPEN!

i **10**
Meer informatie



24,90



1 x		120 mm	1 x		160 mm
1 x		120 mm	3 x		PH00 - PH0 - PH1
1 x		120 mm	3 x		2,0 - 2,4 - 3,0 mm

500.7220

i **21**
Meer informatie

99,90

2 x		125 - 130 mm	3 x		PH00 - PH0 - PH1
1 x		100 mm	4 x		1,4 - 2,0 - 2,4 - 3,0 mm
1 x		100 mm	7 x		T6 - T7 - T8 - T9 - T10 - T15 - T20
1 x		125 mm			
1 x		150 mm			
1 x		145 mm			

500.7190

i **1**
Meer informatie

met stevige, op een kraspen
lijkende instelpunt

5,90

Met starre magneetkop

550.1001 2-in-1 telescoop-magneethouder met ruitensproeierreinigungs- en afstelgereedschap

i **1**
Meer informatie

met dunne reinigungsstift

7,90

met flexibele magneet-kop

550.1023 2-in-1 telescoop-magneethouder met ruitensproeierreinigungs- en afstelgereedschap

i **1**
Meer informatie

9,90

550.1136 Flexibele inspectiespiegel met verlichting

i **5**
Meer informatie

NIEUW

14,90

5 IN 1

550.1145

Inclusief snelvergrendeling

i **4**
Meer informatie

9,90

45° 135° 0° 90°

550.1045

i **9**
Meer informatie

19,90

45° 135° 0° 90° 45° 90° 0°

550.1070

i **1**
Meer informatie

8,90

Piezo

115 mm

960.1110

i **1**
Meer informatie

19,90

300 mm

550.1060

i **8**
Meer informatie

19,90

95 mm

Ø 40 mm

49 mm

5 mm

Ø 1,6 mm

Ø 3,5 mm

Ø 4,5 mm

960.1265

i **11**
Meer informatie

29,90

Piezo

200 mm

20 mm

33 mm

Ø 1,6 mm

Ø 3,5 mm

Ø 4,5 mm

Ø 5 mm

30 mm

95 mm

95 mm

Ø 40 mm

ISO BUTAN

960.1160 Micro-soldeerset

i **283**
Meer informatie

169,90

220 mm

Ø 0,5 - 6 mm Ø 0,5 - 6 mm

Ø 0,5 - 10 mm Ø 6,50 / 5,41 / 1,72 mm Ø 0,5 - 4 mm

Ø 1,0 - 3,2 mm

115.1400

i **1**
Meer informatie

3,90

143 mm

118.0013

i **1**
Meer informatie

vanaf 2,90

EG II

A 16 mm B 19 mm C 25 mm D 25 mm

	300.0113	300.0114	300.0115	300.0116
A	3 m	5 m	5 m	8 m
B	16 mm	19 mm	25 mm	25 mm
C	2,90 €	3,90 €	4,90 €	5,90 €

115.1400

i **5**
Meer informatie

Temperatuurregeling:
1≈50°C / 2≈100°C / 3≈200°C /
4≈350°C / 5≈550°C / 6≈650°C

260 mm

1 2 3 4 5 6

1 max. 450°C
2 max. 650°C

29,90

960.1190

Toepassing:
Verwijderen van verf, solderen van leidingen,
krimpen van PVC, lassen en buigen van
kunststoffen, drogen, ontdooien, enz.

i **1**
Meer informatie

IP 34

15+1 m

3x 1,5 mm²

230 V
50 Hz

1000/3000 W

10 A

134,90

150.4217

i **12**
Meer informatie

9,90

145 mm

5,0 x 1,0 mm
5,0 x 1,0 mm
3,0 mm
3,0 mm
5,0 mm
5,0 mm
3,0 mm
2,0 mm
2,0 mm
5,0 mm
5,0 mm
5,0 mm

140.3050

i **5**
Meer informatie

29,90

200 mm

140.3000

i **1**
Meer informatie

138 x 69 x 31 mm 342 9 V Data Hold

19,90

69 mm 138 mm

150.1495

i **1**
Meer informatie

3 - 48 V

140 mm

11,90

550.1503 Polariteits- en spanningstester 3 - 48 V

i **1**
Meer informatie

6 - 24 V

125 mm

4,90

550.1504 Proeflampje 6 - 24 V

i **1**
Meer informatie

AUTOMATIC DIGITAL MULTIMETER

143 x 70 x 16 mm 119 AAA Data Hold

16 mm

143 mm

70 mm

49,90

150.1765

Nr. Beschrijving

- Aan/uit-knop
- Functioneschakelaar
- Capaciteitsschakelaar
- Verlichtingsschakelaar
- LCD-display
- NCV-sensorbereik
- Meetleidingen

Symbol	Uitleg
	Gelijkspanning
	Wisselspanning
	Indicatie voor automatische uitschakelfunctie
	Indicatie voor laag batterijniveau
	Dioden-modus
	Doorgang
	Capaciteit
	Duty-cycle (inschakelverhouding)
HOLD	Data-hold functie
V, mV	Spanningseenheid: volt, millivolt
mF, μF, nF	Capaciteitseenheid
MΩ, KΩ, Ω	Weerstandseenheid
NCV	Contactloze spanningsinductie
Live	Controle van spanningvoerende leidingen
KHz, Hz	Frequentie-eenheid
°C/°F	Celsius/Fahrenheit

NCV

USB-A USB-C

3 COLOUR ANALOG BAR BUZZER ALARM

i **3**
Meer informatie

210 x 88 x 44 mm
655
9 V
Data Hold

34,90

27,0 mm

max. meetbare kabeldiameter 29,0 mm

150.0925

i **1**
Meer informatie

voor gelijk en wisselspanning

AC	6 - 50 - 120 - 230 - 400 V
DC	6 - 50 - 120 - 230 - 400 V

23,90

550.1501

UNIVERSELE-SCHAKELKASTSLEUTEL

i **1**
Meer informatie

MINI

42 mm

- 6 - 7 - 8 mm
- ▲ 9 mm
- 3 - 5 mm
- ⊕ PH 2
- ⊖ 7 mm

16,90

130.1010

i **1**
Meer informatie

71 mm

- 6 - 7 - 8 mm
- ▲ 9 mm
- 3 - 5 mm
- ⊕ PH 2
- ⊖ 7 mm

17,90

130.1015

i **1**
Meer informatie

61 mm

- 5 - 7 - 8 mm
- ▲ 9 - 10 mm
- 4 - 10 mm
- ⊕ PH 2
- ⊖ 7 mm

17,90

130.1020

Kabel-trekveer

vanaf **4,90**

10 meter 20 meter

A	150.0960		1	∅ 3,0 mm 10 m	4,90 €
B	150.0970		1	∅ 4,0 mm 20 m	9,90 €

i **1**
Meer informatie

34,90

∅ 3,0 mm

30 meter

115.1113 **Kabelintrekhelpmiddel**

i  **1**
Meer informatie

22,90



- met moment blokkering
- maateenheden in mm en inches
- met schroefdraadtabel

300.0510

i  **1**
Meer informatie

24,90



- met blokkeerschroef en rolverstelling
- voor buiten-, binnen-, niveau- en dieptemetingen

300.0532

i  **1**
Meer informatie

INFRAROOD-THERMOMETER, -38° NAAR 520°



49,90

150.3040

i  **4**
Meer informatie

56,90



Refractometer - optisch testapparaat voor accuvloeistof en antivries

550.1290

i  **4**
Meer informatie

67,90



Refractometer - optisch testapparaat voor accuvloeistof, antivries en AdBlue®-toevoegingen

550.1285

i **4**
Meer informatie

19,90

11 x 115 mm
15 x 185 mm
18 x 320 mm
18 x 470 mm

911.8100 Koevoetset

i **4**
Meer informatie

XL

900 mm
600 mm

0°
45°
75°
90°

179,90

911.8410 Wrikijzeret

i **22**
Meer informatie

700.1200

Universel hydraulische trekkeret
2 + 3-armig

- gering afglijgevaar door automatisch sluitende klemstukken
- 8 verschillende varianten mogelijk
- extreem robuuste spindel met inductief geharde draad
- minder krachtinspanning nodig
- speciaal-gereedschapsstaal

304,90

20 - 35 - 85 mm
235 mm
185 mm
10 t, AG 1.1/2" x 16G
225 mm
170 mm
120 mm
Ø max. 100 mm

i **13**
Meer informatie

NIEUW VOOR NOODGEVALLEN

79,90

0% ✓ 85% ✓

Voor het losdraaien en verwijderen van vastzittende moeren met beschadigde of voor 85% "dolgedraaide" koppen

89,90

ring 45° geknikt

913.3930 8 - 9 - 10 - 11 - 12 - 13 - 14 - 15 - 16 - 17 - 18 - 19 mm **3/8"**

517.1555 6x7 - 8x9 - 10x11 - 12x13 - 14x15 - 16x17 - 18x19 mm



Meer informatie

- voor bouten van M3 - M18
- maakt het uitdraaien van afgebroken schroeven en bouten mogelijk
- conisch toelopende spiraal
- in stabiele kunststofbox



150.1330 Schroeven uitdraaiset

16,90

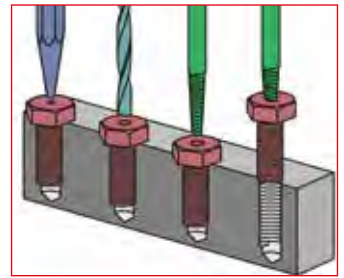
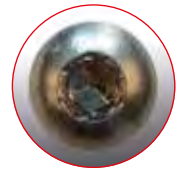

Meer informatie

TORION power

44,90

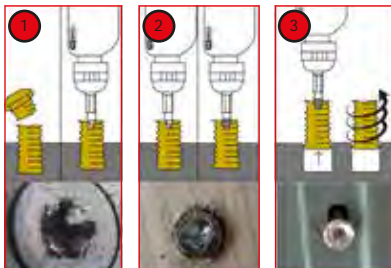

9 x		TE10 - TE15 - TE20 - TE25 - TE27 - TE30 - TE40 - TE50 - TE55
9 x		1,5 - 2 - 2,5 - 3 - 4 - 5 - 6 - 8 - 10 mm
7 x		1,5 - 2 - 2,5 - 3 - 4 - 5 - 6 mm
7 x		T10 - T15 - T20 - T25 - T27 - T30 - T40



150.7060 1/4" + 10 mm Torx- en inbusboutenuitdraaiset



Meer informatie

Schroefdraad-uitdraaiset

- omvangrijke samenstelling van de set
- voor het verwijderen van afgebroken en beschadigde tapeinden en bouten
- geen beschadiging van de schroefdraad
- nagenoeg niet oprekken van de tapeinden door speciaal geprofileerde uitdraaistift



Führungshülse drill guide	Hülse Innen- Ø mm guide	vorböhren Ø mm pre-drilling	aufbohren re-drilling	Stift pin	Art.Nr. Stift No. Pin	Mutter D nut D	Art.Nr. Mutter nut D	Stift + Mutter pin + nut
150.0501	4,0 / 3,2	3,2	-	3,2	150.0521	SW 10	150.0511	150.0511S
150.0502	4,8 / 3,2	3,2	-	3,2	150.0521	SW 10	150.0511	150.0511S
150.0503	4,8 / 3,2	3,2	4,8	4,8	150.0522	SW 11	150.0512	150.0512S
150.0504	4,8 / 3,2	3,2	4,8	4,8	150.0522	SW 11	150.0512	150.0512S
150.0505	6,0 / 4,8	4,8	6,4	6,4	150.0523	SW 13	150.0513	150.0513S
150.0506	7,0 / 4,8	4,8	6,4	6,4	150.0523	SW 13	150.0513	150.0513S
150.0507	7,0 / 4,8	4,8	8,0	8,0	150.0524	SW 14	150.0514	150.0514S
150.0508	7,0 / 4,8	4,8	8,7	8,7	150.0525	SW 17	150.0515	150.0515S
150.0509	9,0 / 6,5	6,4	8,7	8,7	150.0525	SW 17	150.0515	150.0515S
150.0510	9,5 / 6,5	6,4	8,7	8,7	150.0525	SW 17	150.0515	150.0515S

39,90

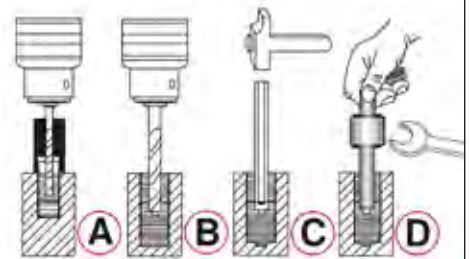

150.1305 M5 - M6 - M8 - M10 - M12 - M14 - M16



Meer informatie

Tapeind-uitdraaiset

- Buitenzeskantaandrijving 21,0 mm
- met rechts- en linksspanfunctie
- goede grip door 3 klembussen
- in en uitdraaien zonder twee moeren op het tapeind te hoeven draaien
- ook voor langere tapeinden geschikt - omdat de schacht hol is

49,90



152.1101 M5 - M6 - M7 - M8 - M10 - M12 - M14



Meer informatie

HSS Co schroefdraad-snijgereedschapset in cassette

- universeel inzetbaar
- rechte tappen
- met verstelbare snij-ijzer- en tappenhouder
- inclusief draadmal en schroevendraaier
- hoogwaardig staal van kobaltlegering



HET ONTBREEKT AAN NIETS



33 x		M3 - M4 - M5 - M6 - M8 - M10 - M12 M14 - M15 - M18 - M20
11 x		M3 - M4 - M5 - M6 - M8 - M10 - M12 M14 - M15 - M18 - M20
6 x		M3-M4 - M4,5-M6 - M7-M9 - M10-M11 - M12-M14 - M16-M20
2 x		M1-M10 - M5-M20

499,90

331.0754



Meer informatie

LEDEREEN DRAAGT HET GRAAG!

24,90



EN388



4131X

Micro-gebreid

	Maat	Verpakking
310.0490	7	12 paar
310.0491	8	12 paar
310.0470	9	12 paar
310.0475	10	12 paar
310.0480	11	12 paar



Meer informatie

3,90



310.0120

FLAME-DESIGN

Meer informatie

49,90

310.0155

STEEL-DESIGN

Meer informatie

49,90

310.0195

EN 379 1/1/1/2	EN 175
Technische gegevens:	
Kleurkeuze:	traploos regelbaar van DIN 9-13 Standaard lichtafstelling: DIN 4
Omschakelreactietijd:	1/25.000 s 0,2 - 0,8 s (instelbaar)
UV/IR bescherming:	volgens EN 169 / tot DIN 16
Bedrijfstemperatuur:	-5°C tot +55°C
Bewaartemperatuur:	-20°C tot +70°C
Stroomvoorzorging:	d.m.v. solarcellen
Hoogte:	220 mm
Breedte:	200 mm
Lengte:	295 mm
Gewicht:	480 g
Afmetingen cassette:	110 x 90 x 9 mm
Kijkglas:	92 x 42 mm

Universele pompverstuiver

Meer informatie

- van hoogwaardige polyethyleen
- Voor diverse chemicaliën, zoals bijv. spoel-, oplos- en reinigingsmiddelen, etc.
- Ongeschikt voor remmenreiniger
- Sproeihoek van messing, verstelbaar en afsluitbaar
- Afdichtingen van Viton®
- geschikt om boven je hoofd te werken

vanaf 14,90

150.8251 1L 14,90 €
150.8252 2L 19,90 €

NIEUW

Meer informatie

0,25 L
max. 8 bar (116 psi)
60°C / 140°F

115 mm

250 mm

0,25 L

Aluminium

49,90

150.8272

Speciaal voor remmenreiniger

i  **16**
Meer informatie

EVOLUTION SERIES

Vlakschraper-set

- geschikt voor het verwijderen van stickers, lijm- en kitresten
- eenvoudige wissel van het mes door het losdraaien van de spanner
- praktische set door de verwisselbare mes-modellen
- bijzonder geschikt voor verschillende doeleinden door de verschillende messen
- Schraper met 2-componenten greep

Vervangingsklingen: 907.2202, 907.2203, 907.2204, 907.2205, 907.2206

NIEUW

5x  12 mm
5x  16 mm
5x  20 mm

 145 mm

12,90

907.2255

i  **27**
Meer informatie

Messen-schraper-set

 145 mm

5x  19 mm

5x  12 mm
5x  16 mm
5x  16 mm
5x  20 mm

 145 mm

19,90

907.2200

Stickerschraper

A  110 mm
B  145 mm **vanaf 3,90**

A	907.2240			1	110 x 39 mm	3,90 €
B	907.2242			1	145 x 40 mm	4,90 €

Klapmes met vergrendeling

A  190 mm
B  220 mm



A	907.2105			1	190 x 25 mm	10,90 €
B	907.2190			1	220 x 28 mm	11,90 €

vanaf 10,90

i  **2**
Meer informatie

14,90







907.2172 **Klapmessenset**

i  **3**
Meer informatie

39,90



118.0050 **Hefboom-blikdoorgangsscharenset**

Wi-Fi-videoscoopset met Ø 5,5 mm 0° HD-frontcamera-sonde

Meer informatie

HD

Ø 5,5 mm

Wi-Fi

Ø 5,5 mm

IP68

3500 mm

39,90

550.7560

EXTEND YOUR EYE

vanaf **239,90**

Edelstaalhuls
Schroefaansluiting voor toebehoren

Kroondesign (bescherming + optimale Reiniging)

Camera

Lens

LED

Edelstaalhuls met buitenschroefdraad

Saffierglas

1500 mAh Li-polymer

Ø 6,0 mm

Ø 4,5 mm

1000 mm

Aansluiting sonde

3,5"

USB 2.0

microSD

HD

6 dimbare Mini-LED'S

Ø

0° 90°

Ø

1000 mm

50 mm

IP 67

AVI 1280 x 720

JPG

150 mm

-10°/+60°C

Magneet

Haak

A	550.7500	5	6,0 mm	0° + 90°	239,90 €
B	550.7530	7	4,5 mm	0° + 90°	299,90 €





Meer informatie



6 dimbare
Mini-LED'S

Ø
3,9 mm

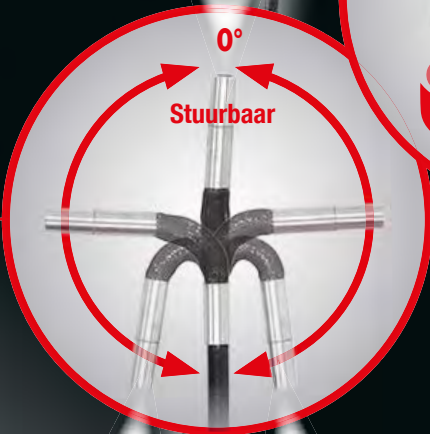

Stuurbaar

180°

180°



draaibaar

360°



Aansluiting sonde



449,⁹⁰

+ 32 GB

550.7550 HD-videoscoopset met Ø 3,9 mm 180 en 0° HD-frontcamera-sonde, flexibele PVC-huls





Ø 12 - 35 MM



Ratel-pijpsnijder

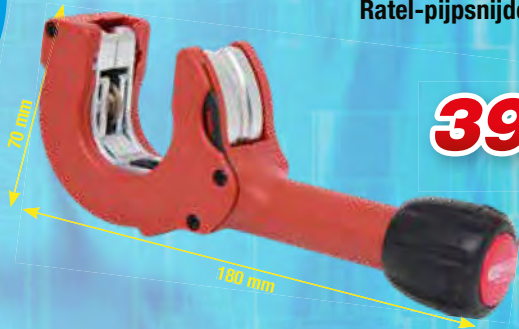

39,90



Ø 28 - 67 MM



Ratel-pijpsnijder



129,90



FUGENFIX™

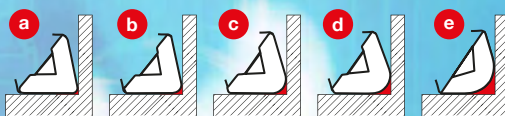

7,90



FUGENFIX Kitschraper- en afwerkset



Schroefdraad-snijset 3/8" - 1.1/4"

3/8"
1/2"
3/4"
1"
1.1/4"

79,90



116.2000



57,90

Afvoerfix

130.3000

1/2"

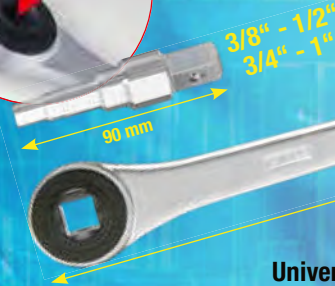

19,90

Universele radiatorsleutelset 3/8" - 1"

903.5902

- vlamtemperatuur ca. 1.700°
- werktemperatuur ca. 650°
- solderen tot max. Ø 22 mm
- levering zonder gaspatroon
- gebruik alleen met standaard hoogwaardige branders
- behuizing van kunststof



24,90

Universele brander met piezo ontsteking

907.2113

Japanse trekzaag, dubbel getand



17x pro 2,5cm

8x pro 2,5cm

325 mm

17,90



850.0300

SMARTBAG universele-gereedschaptas

73,90

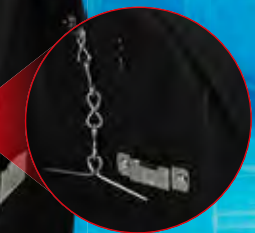

NIEUW



Compacte en robuuste constructie:

Door hoogwaardige kunststoffen en stevige schroefverbindingen biedt de accu bijzonder goede bescherming tegen mechanische invloeden.



18V eMONSTER accu-systeem

Het krachtige 18V eMONSTER accu-systeem combineert een reeks professionele draadloze elektrische gereedschappen. Alle apparaten kunnen worden gebruikt met één accu-systeem. Het assortiment is breed en wordt voortdurend uitgebreid. Elk nieuw apparaat kan ook met dit accu-systeem worden gebruikt. Zo kun je dit accu-systeem jarenlang gebruiken en uitbreiden met eMONSTER 18V-apparaten - je blijft in een accufamilie.



Warmteafvoer:

Door een geribde constructie wordt de warmte net als bij een koelelement geleid naar de omgevingslucht.



Extra bescherming voor een lange levensduur van de accu:

Overspanningsbeveiliging

- Bescherming tegen ontoelaatbaar hoge spanningsbronnen

Laagspanningsbeveiliging

- Bescherming tegen diepontlading tijdens gebruik

Temperatuurmanagement

- Samenspel van machine en accu, voor het verhinderen van een overbelasting van de accu



Actieve luchtkoeling:

(alleen bij 8,0 Ah snellaadapparaat) De geïntegreerde ventilator van het 8,0 A snellaadapparaat, levert tijdens het laadproces doorlopend frisse lucht, zodat de in de accu en het laadapparaat ontstane warmte zoveel mogelijk wordt gereduceerd. Door deze besparende laadprocedure wordt levensduur van de accu duidelijk langer.



Geoptimaliseerde celplaatsing:

Door de pijpconstructie worden de individuele cellen in het warmtegeleidende kunststof geschoven. Zo ontstaat een stevig contact tussen de cel en het warmtegeleidende kunststof. Er is geen isolerende luchtlaag meer aanwezig, die de warmtegeleiding vermindert.





eMONSTER brushless accuschroef-/boormachineset

MINI



159,90

Aanhaalmoment max: 40 Nm
Aandrijving: 10 mm snelspanboorkop

515.6400

INCLUSIEF



Accuspanning: 18,0 V
Max. laadstroom: 3 A

Accuspanning: 18,0 V
Accutechnologie: Lithium-ionen
Accucapaciteit: 2,0 Ah

Levering incl. twee 2,0 Ah accu's en 3 A snellaadapparaat



eMONSTER brushless acculagschroef-/boormachineset



189,90

Aanhaalmoment max: 60 Nm
Aandrijving: Metaal 13 mm Röhm-snelspanboorkop

515.6300

INCLUSIEF



eMONSTER 1/2" brushless accu-slagschroefmachineset



269,90

max. losdraai-moment: 690 Nm
Aandrijving: 1/2"

515.6100

INCLUSIEF



Accuspanning: 18,0 V
Max. laadstroom: 8 A

Accuspanning: 18,0 V
Accutechnologie: Lithium-ionen
Accucapaciteit: 4,0 Ah

Levering incl. twee 4,0 Ah accu's en 8 A snellaadapparaat



eMONSTER brushless haakse accuslijpmachineset



299,90

Toerental: 9000 Ommw/min
Trillingsversnelling: < 4,831 m/s²
3,371 m/s²

515.6200



NIEUW

1/4" TORSIONpower bit-set in eMONSTER-accu-design, 32-dlg

9,90

515.6932

- 1 x 1/4"
- 1 x 1/4"
- 4 x 3 - 4 - 5 - 6 mm
- 4 x PH1 - 2 x PH2 - PH3
- 4 x PZ1 - 2 x PZ2 - PZ3
- 4 x 3 - 4 - 5 - 6 mm
- 7 x T10 - T15 - T20 - T25 - T27 - T30 - T40
- 7 x TB10 - TB15 - TB20 - TB25 - TB27 - TB30 - TB40



Kan bij de 18 V eMONSTER apparaten als accu-dummy worden opgestoken en vergrendelt

HIER GEBEURT HET SLAG VOOR SLAG!

1.390 N·m

1/2"

90 mm

165 mm



515.1150

1  **199,90**

1.390 N·m

1/2"

95 mm

190 mm



515.1270

2  **149,90**

1.084 N·m

1/2"

115 mm

180 mm



515.1315

3  **69,90**

1.600 N·m

1/2"

170 mm

188 mm



515.1200

4  **69,90**

2.000 N·m

3/4"

170 mm

185 mm



515.3400

5  **124,90**

1.690 N·m

1/2" 3/4"

175 mm

200 mm



515.1210

6  **149,90**

7  **189,90**

3.405 N·m

3/4" 1"

40 mm

350 mm



515.3250

9  **849,90**

11  **849,90**

3.405 N·m

3/4" 1"

195 mm

350 mm



515.3260

10  **904,90**

12  **904,90**

													
		Nm	U/min	m/s²	dB(A)	dB(A)	U/min	PT				kg	
1	515.1150	1/2"	1390	10.000	<9,18	102,0	113,0	135	1/4"	-	✓	-	1,08
2	515.1270	1/2"	1390	10.000	<9,18	102,0	113,0	135	1/4"	-	✓	-	1,3
3	515.1315	1/2"	1084	9000	<10,36	106,0	115,0	169	1/4"	-	✓	-	1,2
4	515.1200	1/2"	1600	8500	<17,5	89,9	100,9	169	1/4"	✓	-	-	2,1
5	515.3400	3/4"	2000	8500	<17,25	91,0	100,9	196	1/4"	✓	-	-	2,2
6	515.1210	1/2"	1690	7930	<17,9	87,0	98,0	178	1/4"	✓	-	-	2,1
7	515.3785	3/4"	1690	7930	<13,56	88,0	104,0	178	1/4"	✓	-	-	2,2
8	512.0002	1/2"	2300	8500	<8,69	99,7	110,9	244	1/4"	✓	-	✓	1,6
9	515.3250	3/4"	3405	6200	<12,57	115,5	104,5	283	1/2"	✓	-	-	6,7
10	515.3260	3/4"	3405	6200	<12,88	115,5	104,5	283	1/2"	✓	-	-	7,7
11	515.3270	1"	3405	6200	<12,57	115,5	104,5	283	1/2"	✓	-	-	6,7
12	515.3280	1"	3405	6200	<12,88	115,5	104,5	283	1/2"	✓	-	-	7,8

 hoogwaardig Twin-Hammer-Clutch systeem

 Hoogwaardig Jumbo-hamerslagmechanisme

 BITURBO technologie

Alle prijzen in EUR excl. BTW gelden tot en met 30-09-2024

i **1**
Meer informatie

Vetopbrengst: telkens een slag per levering

200 mm

400 g

400 mm

66,50

515.3900 Perslucht-vetspuit voor vettransport met slagen

i **1**
Meer informatie

vanaf 24,90

PU

515.3330	6,0 mm	G1/4" AG	8,0 m	24,90 €
515.3335	8,0 mm	G1/4" AG	15,0 m	34,90 €
515.3340	10,0 mm	G3/8" AG	15,0 m	39,90 €

i **1**
Meer informatie

9,90

Regelbaar

100 mm

515.1901 Uitblaaspistool met doorstroomregelaar

i **3**
Meer informatie

19,90

510 mm

330 mm

95 mm

515.1921 Uitblaaspistool-set

Oprolautomaat voor luchtslang

15 m

1,5 m

180°

STOP

i **1**
Meer informatie

119,90

Ø 10 MM X 15 M

A

Technische gegevens:

Binnendiameter slang:	10,0 mm
max. Druk:	20,0 bar
Draad aansluiting:	1/4"

515.3440

i **1**
Meer informatie

179,90

Ø 13 MM X 15 M

B

Technische gegevens:

Binnendiameter slang:	13,0 mm
max. Druk:	20,0 bar
Draad aansluiting:	3/8"

515.3445

i **1**
Meer informatie

480 mm
320 mm
1.150 mm
36 mm
36 mm
550 mm

vanaf
11,90

	↔		
A	500.8040	480 mm	11,90 €
B	500.8045	1.150 mm	39,90 €

i **1**
Meer informatie

360 mm
365 mm
360 mm

1
49,90

500.8020

i **1**
Meer informatie

400 - 540 mm

2
59,90

500.8030

i **1**
Meer informatie

**HOOG BELASTBAAR
TOT 135 KG**

max. 135 kg
463 - 580 mm
360 mm

3
69,90

500.8004

i **1**
Meer informatie

400 mm
85 mm
490 mm
1.040 mm

4
69,90

500.8011

i **1**
Meer informatie

420 mm
145 mm
1.200 mm
510 mm
145 mm

6
99,90

500.8000

	1	2	3	4	5	6
Technische gegevens:	500.8020	500.8030	500.8004	500.8011	500.8090	500.8000
Kleur	rood	rood	rood	rood	rood	rood
Materiaal	Stalen buis	Metaal	Metaal	Metaal	kunststof	Metaal
Aantal draaiwielen	4	5	5	6	6	6
verrijdbaar	✓	✓	✓	✓	✓	✓
Bandentype	Kunststof	Kunststof	Rubber	Kunststof	Kunststof	Kunststof
gevoerd	✓	✓	✓	✓	✗	✓
Camerascherming	✗	✓	✓	✓	✗	✓
Inhoud verpakking	1	1	1	1	1	1
Totale lengte L in mm	365,0 mm	370,0 mm	360,0 mm	1040,0 mm	1030,0 mm	1200,0 mm
Breedte B	360,0 mm	370,0 mm	360,0 mm	490,0 mm	480,0 mm	420,0 mm
Hoogte H	360,0 mm	420,0 - 540,0 mm	463,0 - 580,0 mm	85,0 - 400,0 mm	115,0 mm	145,0 - 510,0 mm
Totale draagkracht kg	90 kg	90 kg	135 kg	90 kg	120 kg	90 kg

i **1**
Meer informatie

DE LICHTSTE

480 mm
1.030 mm
115 mm

5
67,90

500.8090

i  **3**
Meer informatie

Geniaal flexibel

NEUW

44,90

500.8077 Gereedschapopbergset van siliconen

1 53 x 29,5 x 3,2 cm

2 25,5 x 23,3 x 2,4 cm

3 27,5 x 14,5 x 2,4 cm

i  **1**
Meer informatie

- met stroef profiel op de loopplank
- met groter plateau voor veilig gebruik
- rubber doppen in de poten beschermen het plateau en ondergrond

99,90

800.0960 Aluminium veiligheids plateau

960 mm, 300 mm, 495 mm

max. 150 kg

VOOR UW VEILIGHEID

TÜV SÜD (Safety Institute for Product Inspection)

GETEST!

i  **1**
Meer informatie

- met ribbel-profiel op de trede
- staat stabiel door schuin geplaatste poten
- inklapbaar en daarom ruimtebesparend

54,90

800.0965 Aluminium uitzettrap

600 mm, 440 mm, 620 mm

max. 150 kg

VOOR UW VEILIGHEID

TÜV SÜD (Safety Institute for Product Inspection)

GETEST!

Meer informatie

MAXIMAAL WERKOPPERVLAK

1199,90

XXL

840 mm

2000 mm

680 mm

865.0201 **XXL-werkbank met 3 schuifladen en 1 deur**

Meer informatie

KLEIN EN GROOT TEGELIJK!

179,90

257 - 1380 mm

845 - 1320 mm

257 - 1380 mm

500.8100 **Universele multifunctionele telescoopwagen met rollen**

Meer informatie

NIEUW

180°

Ø 440 mm

3 5000 rpm, 57 dB, 4,9 m/s, 56,9 W

2 4500 rpm, 51,5 dB, 4,3 m/s, 53 W

1 4000 rpm, 48 dB, 3,5 m/s, 49 W

49,90

610 mm

570 mm

**EXTREEM STIL
ULTRALICHT
< 3,5 KG**

999.2000 **Werkplaatsventilator, 70 Watt**

Meer informatie

Parallel bankschroef

360° met draaiplaat

vanaf 165,90

bekken en aambeeld inductief gehard

914.0004	120 mm	4"	165,90 €
914.0005	140 mm	5"	178,90 €
914.0006	160 mm	6"	189,90 €
914.0008	200 mm	8"	229,90 €

i

Meer informatie

max. 8 bar (116 PSI)	60° C 140° F

19,90

1 Water **2** Detergent **3**

Max. 40° C Max.

4 **5** Switch Lock

150.8271 Drukpompschuimspuit (schuimer)

i

Meer informatie

84,90

350 mm

650 mm

500.8013 Verrijdbare kruk

i

Meer informatie

6,3 bar	96 L/min
92 dbA	1/4" PT

39,90

Zuigen Blazen

145 mm 3/8" - Ø 10 mm

515.5090 Pneumatisch zuigpistool

Meer informatie

515.1243 Caramelschijf

5,90

Meer informatie

515.1247 Caramelschijf met lamellen

15,90

Meer informatie

SETPRIJS = 6x

515.1285

29,90

Meer informatie

SETPRIJS = 6x

515.1366

89,90

Meer informatie

141,90

515.1980 Pneumatisch reinigingspistool

ON - OFF

Industrieel kogellager

Regelbaar

360°

30°

1/4" NPT	8000	160 Liter
6,3 bar (90psi)	3/8" 10 mm	<3,90 m/s²
106 dbA	95 dbA	1000 ml

OPTIONEEL

Meer informatie

515.1983 Borstelopzetstuk

5,90

Meer informatie

515.1986 Borstel-kwast

5,90

i **6**
Meer informatie

29,90

510 mm

4 mm
8 mm
10 mm

4 mm
8 mm
10 mm

245 mm

140.2370 **Clip-verwijderset**

i **11**
Meer informatie

19,90

180 mm 200 mm 200 mm 200 mm 210 mm

160 mm 200 mm 200 mm 180 mm 200 mm 200 mm

911.8205 **MASTER Kunststof wigset**

i **1**

Meer informatie

- verwijdert geuren en desinfecteert het voertuiginterieur
- automatische uitschakeling in geurverwijderingsmodus na 60 minuten
- werkt zonder chemische toevoegingen, waardoor een reiniging zonder reststoffen gegarandeerd is
- laat zelfs op gevoelige oppervlakken geen sporen achter
- verwijdert schimmel, bacteriën en meeldauw

173 mm

49 mm

122 mm

79,90

550.1183 **Plasma-luchtzuiveraar met ionisator-techniek**

i **1**
Meer informatie

- Zeer geschikt voor het reinigen van dunne buizen, slangen of afvoeren
- aan beide kanten te gebruiken
- Flexibele RVS-slang
- Nylon borstels

3,90 **NIEUW**

Ø 16 mm

Ø 22 mm

150.1762 **Flexibele reinigingsborstel**

i **7**
Meer informatie

Ø 0 - 38 mm

Ø 0 - 48,5 mm

Ø 0 - 65 mm

Ø 0 - 30 mm

Ø 0 - 45 mm

Ø 0 - 45 mm

Ø 0 - 60 mm

79,90

115.1055 **Automobil slangklemtangenset**

i **3**
Meer informatie

9,90

Ø 15 mm Ø 30 mm Ø 60 mm

150 mm 180 mm 250 mm

115.5050

i **3**
Meer informatie

Ø 15 mm Ø 35 mm Ø 23 mm

155 mm 255 mm 165 mm

12,90

115.5055

i **1**
Meer informatie

14,90

Afzuig- en vulhandpomp

150.9221

i **1**
Meer informatie

19,90

100 mm

Speciale 3/8" steeksleutel voor zuigbuis-schroefkoppelingen

150.2519

i **1**
Meer informatie

19,90

12V 5A 60W
Richtung Direction
150.2620

PETROL DIESEL OIL

Elektrische olieaanzuig- en transferpomp

150.2620

i **1**
Meer informatie

4,90

Wisseldop voor 30 - 45 mm en 60 - 80 mm slangklemmen

NIEUW

30 mm

1

2

Speciale 2-in-1 dopsleutel voor slangklemmen met 3-puntsprofiel

115.0915

i **1**
Meer informatie

12,90

NIEUW

1/2"

108 mm

150.1919

Radiatorop-demontagegereedschap voor VAG





25

Meer informatie









0 - 2,5 bar



max. 76 cm



0 - 200 °C
0 - 400 °F



1600 mm



R123
R124



R123
R125



#1



#2



#3



M50 x 2,5



M42 x 3



M58 x 3



M62 x 3



M48 x 4



M45 x 3



M50 x 2,5



M60 x 4



M52 x 3



M48 x 2,5



M42 x 2,5



M50 x 3



M46 x 3



M34 x 2,5



75 mm

179,⁹⁰

MASTER
koelsysteem-diagnose-serviceset



150.1930





1

Meer informatie

Koppeling 7,2 mm naar 4,4 mm



NIEUW



7,2 mm



4,4 mm

80 mm

19,⁹⁰

150.1936





1

Meer informatie

Koppeling 4,4 mm naar 7,2 mm



NIEUW



4,4 mm



7,2 mm

74 mm

24,⁹⁰

150.1937

i  **8**
Meer informatie

250 ml

99,90

150.1910 CO2-cilinderkop-lekkagetestset

OPTIONEEL BIJ TE KOPEN

14,90

150.1914

i  **3**
Meer informatie

53 x 29,5 x 3,2 cm

1

2 **25,5 x 23,3 x 2,4 cm**

3 **27,5 x 14,5 x 2,4 cm**

GENIAAL FLEXIBEL

NIEUW

44,90

500.8077 Gereedschapopbergset van siliconen

i 2
Meer informatie

EcoBoost

NIEUW

180 mm + 215 mm

14 mm + 16 mm

24,90

VOOR FORD ECOBOOST MOTOREN 1,0 LITER

VOOR FORD ECOBOOST MOTOREN 1,5 LITER

517.1135 **Bougiedopset voor EcoBoost-motoren**

i 2
Meer informatie

M20 x 1.5 + M22 x 1.5

27 mm

13 mm

Met 6 snijtanden voor ideale centering

Met reinigingsgroeven in geleidingspen

179,90

150.2540 **Schroefdraadtapset met geleidepen voor sensoren**

GENIALE PROBLEEMOPLOSSER

NIEUW

i 1
Meer informatie

Schroefdraadtap met geleidingspen

Voor het opsnijden van verroeste en beschadigde speciale schroefdraad

13 mm

Met 6 snijtanden voor ideale centering

Met reinigingsgroeven in geleidingspen

99,90

			L1	L2			
A	150.2541	Voor temperatuursensoren	M12 x 1,25	55 mm	33 mm	13 mm	99,90 €
B	150.2542	Voor temperatuursensoren	M14 x 1,5	45 mm	30 mm	13 mm	99,90 €
C	150.2543	Voor lambdasonden	M18 x 1,5	42 mm	27 mm	13 mm	99,90 €
D	150.2544	Voor NOX-sensoren	M20 x 1,5	50 mm	27 mm	13 mm	99,90 €
E	150.2546	Voor roetfiltersensoren	M22 x 1,5	50 mm	27 mm	13 mm	99,90 €

i  **1**
Meer informatie

19,90



1 **2**

Bobinetrekker voor staaftobines

500.7505



i  **7**
Meer informatie

VOOR VAG EN OPEL MOTOREN

69,90



1 **2** **3** **4** **5** **6** **7**

Bobinetrekset met T-greep voor VAG en Opel motoren

500.7570







i  **7**
Meer informatie

120 ml **120 ml**



6x10
6x6
6x8
6x4
600 mm
Ø 6x9 mm

169,90

Druk- en vacuümpompset

150.1900



i  **24**
Meer informatie



49,90

Universele set montagegereedschap voor keerringen en borgringen

700.1280



i **1**
Meer informatie

max. 165 mm

M 12 x 75 mm

30 mm

40-165 mm

39,90

Universele-riemschijftrekker
2-armig Ø 40-165 mm

150.3170

i **1**
Meer informatie

NIEUW

1/4"

13 mm

Ø 3,0 mm

8 - 25 mm

19,90

- Voor het spannen en ontspannen van de tandriemsparol
- verstelbaar, universeel te gebruiken
- binnenvierkantaandrijving volgens DIN 3120 / ISO 1174
- met buitenzekantaandrijving 13,0 mm
- gefosfateerd

Universele pensleutel voor tandriemsparol, verstelbaar

150.3046

i **1**
Meer informatie

Toepassingsgebieden: Citroën, Peugeot, Opel und Toyota met 1,0 en 1,2 benzinemotoren (motorcode: ZMZ (EB0F / EBO) / HMO1 (1PP) / HMV, HMZ (EB2) / HMZ (EB2 / EB2F) / HMT (EB2D) / HMU (EB2D) / HNZ (EB2DT) / HNY (EB2DTS) / HMV (EB2M) / HMY (EB2M) / B12XE (EB2F) / D12XE (EB2FA) / B12XHL (EB2DT) / D12XHL, F12XHL (EB2ADT) / B12XHT (EB2DTS) / D12XHT, F12XHT (EB2ADTS))

9,90

Tandriem testgereedschap voor PSA

400.2118

i **1**
Meer informatie

M 15 x 1,5 x 71 mm

17 mm

27 mm

70 mm

34,90

Universele trekker voor riempoelies, 3-armig

150.3130

i **22**
Meer informatie

Petrol
Diesel
OIL

- voor de montage en demontage van moeilijk te openen CLIC-leidingkoppelingen met veervergrendeling van brandstof-, airco-, lucht- en hydrauliekleidingen
- geen beschadiging aan steekkoppelingen, brandstofleidingen en brandstofslangen
- snel en eenvoudig scheiden van brandstofleidingen
- voor vrijwel alle leidingkoppelingen van Europese, Aziatische en Amerikaanse voertuigen

115.1260 Leiding-verbinding ontgrendelset

49,90

5/16" 1/4" 5/16" 3/8" 3/8" 1/2" 5/8" 7/8"

3/8" 1/2" 5/8" 3/4" 5/16"

3/8" 1/2" 5/8"

3/4" 7/8" 5/16" x 3/8"

5/16"



Meer informatie

MET 3.873 SLAGEN PER MINUUT TREKT HIJ ALLES ERUIT!

- Inclusief 7 adapters voor vrijwel alle injectoren
- Enorm hoog slageffect (3365 (6,3 bar) / 3873 (8 bar) slagen per minuut)
- voor het uitbouwen van vastgebrande verstuivers in de cilinderkop
- Met de betreffende adapter wordt de trekker op de vastzittende verstuiver vastgeschroefd
- neemt weinig ruimte in door compacte uitvoering

NIEUW



A B C



D



E F G H



3.873 x / min



1/4"

Regelbaar

230 mm

223 L/min	3/4"-19 mm	108,4 dbA
6,3 bar (90 psi)	71,9 m/s²	6 mm
12 bar	119,4 dbA	M18 x 1,5



A	M25 x 1,0	Siemens
B	M20 x 1,0	Denso
C	M27 x 1,0	Siemens
D	M27/M17/10 mm	Bosch/Fiat/BMW/PSA/ Mercedes/Renault
E	M18 x 1,5	Adapter
F	M17 x 1,0	Bosch/Mercedes
G	M16 x 1,0	Toyota
H	M14 x 1,5	Bosch/Delphi/BMW

BOSCH ✓
DENSO ✓
DELPHI ✓
SIEMENS ✓

...

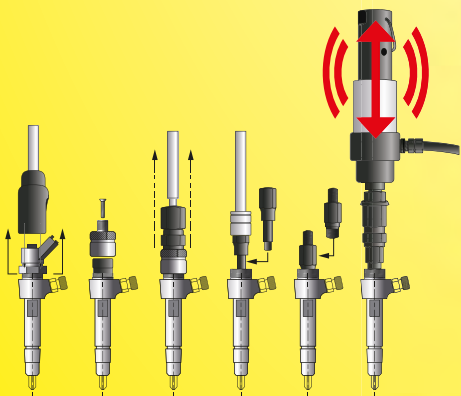

269,90

152.1130 Perslucht-verstuivertrekker

i **6**
Meer informatie

285 - 875 mm
TELESCOPISCH
150 - 675 mm

500g
200g
1000g
2000g
3000g

Ø 4 mm
Ø 13 mm
Ø 16 mm
Ø 19 mm

400 mm
510 mm

NIEUW

26,90

550.1090 Flexibele en telescopische magneethouder- en inspectiespiegelset

i **1**
Meer informatie

125 mm

6 - 24 V
4,90

550.1504 Proeflampje 6 - 24 V

i **1**
Meer informatie

11,90

3 - 48 V

550.1503 Polariteits- en spanningstester 3 - 48 V

i **2**
Meer informatie

129,90

25 m

6 - 24 V

150.1655 Spanningstester

i **2**
Meer informatie

59,90

150.3075 Kortsluitdetector

1 Ontvanger
2 Zender met krokodillenklampen





Meer informatie





369,⁹⁰

 **Accu laden**
 **Onderhoudsladen**
 **Reparatie van de accu**
 **Gelijkstroomvoeding**



geschikt voor 12 en 24 Volt



Temperatuursensor





550.1745 12V + 24V SMARTcharger tweevoudige hoogfrequente acculader, 25A/12,5A

Technische gegevens:

Accucapaciteit:	12V: 75-500Ah - 24V: 45-250Ah
Spanningsbereik:	220-240V AC, 50/60HZ
Laadspanning:	14,4V - 25A (12V), 28,8V - 12,5A (24V)
Frequentiebereik:	50 Hz
Kabel:	H05RN-F 2x1,0 mm ²





Meer informatie





367,⁹⁰

 **Accu laden**
 **Onderhoudsladen**
 **Reparatie van de accu**
 **Gelijkstroomvoeding**



geschikt voor 12 en 24 Volt





Voor vrijwel alle batterijen

Met printer en 3 rollen papier



550.1649 12V / 24V digitale accu- en laadcircuittester met geïntegreerde printer

Technische gegevens:

Scherm:	digitaal
Werkbereik CA / MCA:	40-2.000 CCA
Werkbereik CCA:	40-2.000 CCA
Werkbereik DIN:	40-2.000 CCA
Werkgebied EN:	40-2.000 CCA
Werkgebied IEC:	40-2.000 CCA
Werkbereik JIS#:	40-2.000 CCA
Werkbereik SAE:	40-2.000 CCA
Werktemperatuur:	+0°C tot +55°C
Frequentiebereik:	100 Hz
Meetbereik:	9-36 V
Meetnauwkeurigheid:	+/- 0,5 Megaohm
Spanningsbereik:	9-36 V





Meer informatie





599,⁹⁰

 **Accu laden**
 **Onderhoudsladen**
 **Reparatie van de accu**
 **Gelijkstroomvoeding**



geschikt voor 12 en 24 Volt





1.400 A



Intelligent veiligheidsconcept vermijdt bedieningsfouten:

De veiligheidsschakeling levert pas stroom op de klemmen als:

- Correct is aangesloten (polen correct)
- De verbinding kortsluitveilig is
- De correcte spanning aanwezig is
- De voertuigaccu in orde is

550.1720 12V + 24V Startbooster 1400 A

i  **26**
Meer informatie



3/8"

329,90

Gereedschapset met geïsoleerde gereedschappen voor hybride- en elektrische voertuigen

117.1895

2 x		4 mm - 5,5 mm
2 x		PH1 - PH2
6 x		6 - 8 - 10 - 12 - 13 - 17 mm
1 x		185 mm
1 x		165 mm
1 x		3/8"
1 x		3/8": 200 mm
1 x		3/8": 125 mm
10 x		3/8": 8 - 10 - 11 - 12 - 13 - 14 - 16 - 17 - 19 - 22 mm
1 x		200 mm

i  **43**
Meer informatie

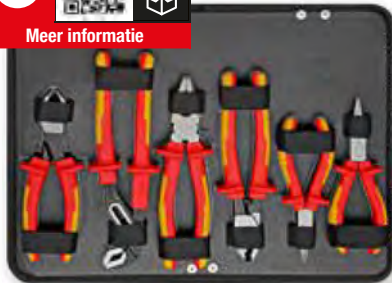

3/8"

564,90

Gereedschapset met geïsoleerde gereedschappen voor hybride- en elektrische voertuigen

117.1890

4 x		2,5 - 3 - 3,5 - 4 mm
3 x		PH1 - PH2 - PH3
3 x		T20 - T25 - T30
1 x		210 mm
1 x		185 mm
1 x		165 mm
1 x		215 mm
1 x		165 mm
1 x		240 mm
2 x		10 - 25 mm
1 x		180 mm
1 x		3/8"
15 x		3/8": 6 - 7 - 8 - 9 - 10 - 11 - 12 - 13 - 14 - 16 - 17 - 18 - 19 - 20 - 22 mm
2 x		3/8": 150 - 250 mm
3 x		3/8": M8 - M10 - M12
1 x		Ø 200 mm
1 x		200 mm
1 x		500 m

i  **18**
Meer informatie



329,90

Steeksleutelset met veiligheidsisolatie

118.1500

18 x		7 - 8 - 9 - 10 - 11 - 12 - 13 - 14 - 15 - 16 - 17 - 18 - 19 - 20 - 21 - 22 - 23 - 24 mm
------	--	---

i  **1**
Meer informatie

<44.500 V



179,90

Geïsoleerde reddingsstang

150.0913



Meer informatie

DE INSTAPSET VOOR ELEKTROMOBILITEIT

ecoLine



1

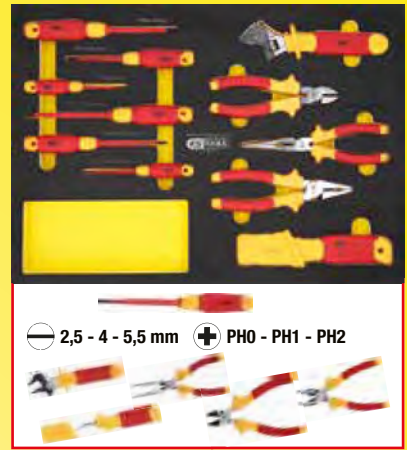

2,5 - 4 - 5,5 mm PH0 - PH1 - PH2

2

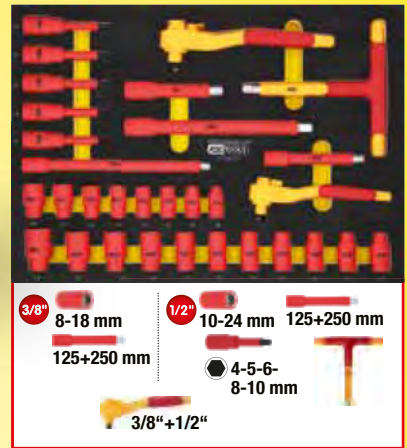

3/8" 8-18 mm 1/2" 10-24 mm 125+250 mm
125+250 mm 4-5-6-8-10 mm
3/8"+1/2"

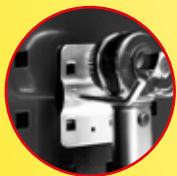

Vierkant gatenpatroon voor accessoires

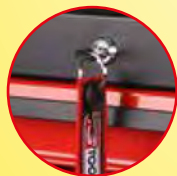

afsluitbaar door ingebouwd cilinderslot



werkblad met 10 mm dikke anti-slipmat



Zelfsluitend en SOFT-CLOSE-functie



2 x rol- en draaiem Ø wielen: 125 mm

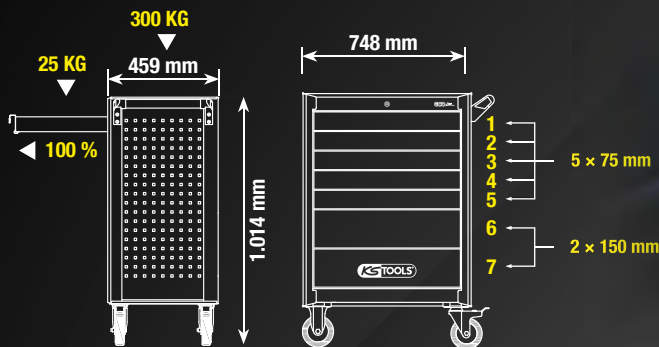

1299,00

INCLUSIEF 42 GEREEDSCHAPPEN

ECOline gereedschapwagen met 42 geïsoleerde gereedschappen voor hybride- en elektrische voertuigen

117.6144

4299,00



917.3898



917.3897



117.3819



117.1660



117.1664



117.1796



117.6172 3/8" + 1/2" geïsoleerde dopsleutelset met momentsleutel in schuimrubberinleg, 72-dlg



117.6133 Geïsoleerde sleutelset in schuimrubberinleg, 33-dlg

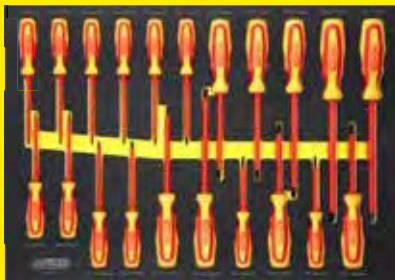

117.6121 ERGOTORQUE VDE schroevendraaierset in schuimrubberinleg, 21-dlg



117.6117 ERGOTORQUE VDE tangenset in schuimrubberinleg, 17-dlg

117.6155

PERFORMANCEplus gereedschapwagen €10 met 164 geïsoleerde gereedschappen voor hybride- en elektrische voertuigen

DE OMVANGRIJKSTE IN Z'N KLASSE

9,90



117.0223

Dakbord met bliksemsymbool en magneet



9,90

117.0222

Dakbord met bliksemsymbool en zuignap



De electromobilitéscatalogus van 188 pagina's vindt u bij www.kstools.com

14,90

117.0226

Bord met bliksemsymbool

69,90

117.1550

Afzetpalenset met ketting



2x

139,90

117.1545

2 x Schaarbarrière van kunststof



i  **4**
Meer informatie

Ø 22,0 - 28,0 mm

Ø 15,0 - 21,0 mm

Ø 17,0 - 25,0 mm

Koppelingscentreer- gereedschapsset

8,90

150.2180 Ø 15,0 - 28,0 mm



i  **11**
Meer informatie

150 kg

310 mm

450 mm

300 mm

394,90

160.0910 Universele versnellingsbakhouderset



i  **3**
Meer informatie

- 1 Vulgereedschap A Monteren en demonteren
- 2 Olie aftappen, gering debiet
- 3 Vulniveau controleren
- 4 Olie aftappen, volledig debiet

24,90

9G-TRONIC

56 mm

20 mm

74,5 mm

9 mm

28,5 mm

39,5 mm

9 mm

152 mm

48 mm

150.9695



160.0910 Universele versnellingsbakhouderset



i  **24**
Meer informatie

DE OMVANGRIJKSTE!

199,90

INCLUSIEF 23-DELIGE ADAPTERSET

150.9261		1/8-27 NPT Ford
150.9262		BMW, Honda, Nissan etc.
150.9263		VAG
150.9264		VAG, Porsche
150.9265		M10 x 1.0 VAG, Mini Cooper
150.9267		M12 x 1.5 Mercedes
150.9268		M24 x 1.5 VAG DSG
150.9269		M22 x 1.5 VAG CVT
150.9271		M18 x 1.5 Skoda
150.9272		M30 x 1.5 VAG, Skoda
150.9273		Universal Flexible 300 mm, Honda, Hyundai, Kia, etc.
150.9274		5/16-24 (UNF) Volvo
150.9276		M18 x 1,5 Toyota / Lexus
150.9277		M8 x 1,0 Nissan / Infinity
150.9278		ATF-Adapter V.W, Passat
150.9562		Nissan Juke M12 x 1,25
150.9563		Mini Cooper M14 x 1,5
150.9564		issan M10 x 1,5
150.9566		GM M12 x 1,75
150.9567		Mercedes 725-9G
150.9102		VAG 7 DSG
150.9103		VAG 7 DSG
150.9104		VAG 7 DSG

NIEUW!

150.9105 Universeel vulsysteem voor versnellingsbakolie, incl. 23 delige adapterset



i  **4**
Meer informatie



111,90

Ø 30 mm

McPherson veerpotsteun voor versnellingsbakkrick

160.0195

i  **7**
Meer informatie



6 mm

99,90

Speciale set montagegereedschappen voor schokdempers met een uitslag-begrenzingsveer

150.9545





VOOR UW VEILIGHEID  **GETEST!**

i  **6**
Meer informatie

universeel voor 90% van alle gangbare schroefveren bij personenauto's en bestelwagens



Ø 80 - 160 mm

Ø 140 - 195 mm

BELASTING max 26000 N

451,90

Technische gegevens:

Veerdruk max.:	2600 kg
Spanwijdte max.:	355,0
Veercapaciteit:	80,0 - 195,0 mm

500.8400 **Universele set veerspanners**

- ideaal voor het monteren en demonteren van Mc Pherson veerpoten
- benodigd bij het vervangen van schokdempers of schroefveren
- universeel voor 90% van alle gangbare schroefveren bij personenauto's en bestelwagens
- kostenbesparend en solide alternatief voor gangbare veerspanners
- ook voor conische en kegelveren geschikt
- TÜV-goedgekeurd

VOOR UW VEILIGHEID



GETEST!

i **11**
Meer informatie

1/2" x 1/2", 100 Nm

Ø 30 mm

Ø 90 - 140 mm

372,90

500.8765 **Telescopische centerspannerset Audi en Seat voor binnenliggende veren**

VOOR UITBREIDING

i **2**
Meer informatie

Ø 95-110 mm

VOOR VEERSPANNER
500.8755 + 500.8765

99,90

500.8770 **Veerbekken per paar Ø 95-110 mm**

Toepassingsgebieden:
Mercedes E-klasse (W211 / W212), C-klasse (W204), GLA (X156),
GLK (X204), Ford Focus II (MK2), BMW 1-serie (E81), Volkswagen Passat (B8 / 3G)

VOOR UITBREIDING

i **9**
Meer informatie

Ø 30 mm

Ø 90 - 140 mm

Ø 75 - 115 mm

338,90

500.8755 **Universele set telescopische centerspanners voor binnenliggende veren**

WARNING - ACHTUNG - ADVARSEL
ADVERTENCIA - AVERTISSEMENT

VOOR 95% VAN ALLE VOERTUIGEN



Meer informatie

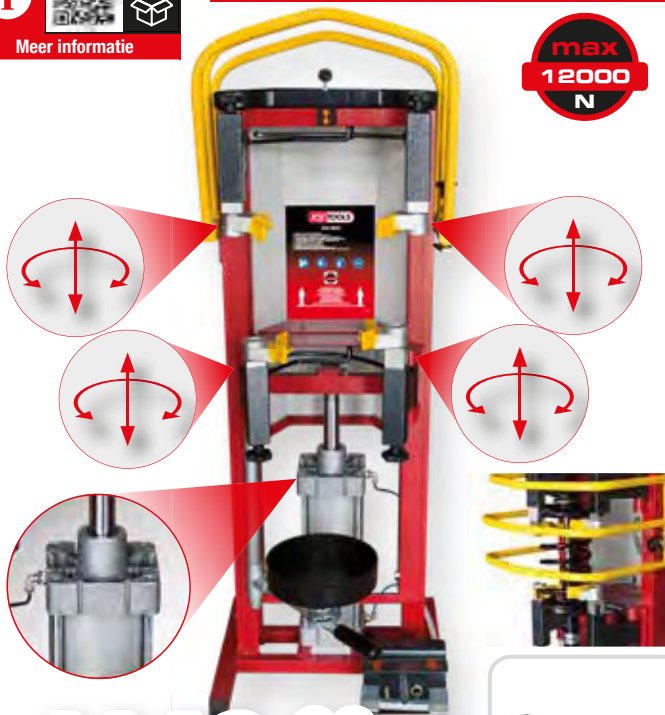

max
12000
N

1149,00

Pneumatische staande veerspanner,
max. 10 bar

500.8800



Meer informatie



max
24000
N

1599,00

Perslucht-stand-veerspanner
met dubbele cilinder

500.8810

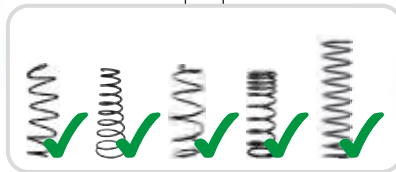

met dubbele
cilinder



Meer informatie



- gemakkelijk in het gebruik
- speciaal-gereedschapsstaal
- ideaal voor veerpoten
- optimaal voor een veilige staande positie bij het monteren en demonteren
- met 4 bevestigingspennen en 4 tapeinden
- levering vindt plaats met 2 borgveren voor de montage

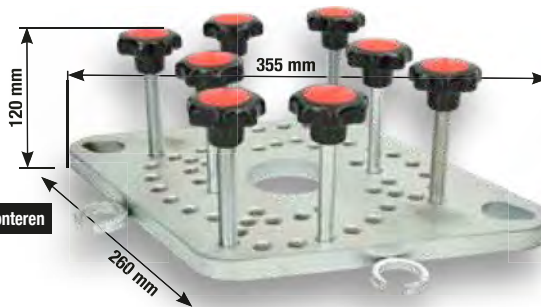

281,90



500.8801 Adapterplaat voor pneumatische aangedreven staande veerspanner

VEERSPANNERSET, INCLUSIEF ADAPTERPLAAT



Meer informatie



Pneumatische
veerspanner incl.
Adapterplaat

1349,00

500.8805



Meer informatie



Pneumatische
staande veerspanner
met dubbele cilinder,
incl. adapterplaat

1799,00

500.8815

CONFIGUREREN ZOALS U DAT WENST



440.9051



1199,90



GROTER DAN U DENKT

REM



440.9087



2499,90

SILENT-LAGERS



440.9025

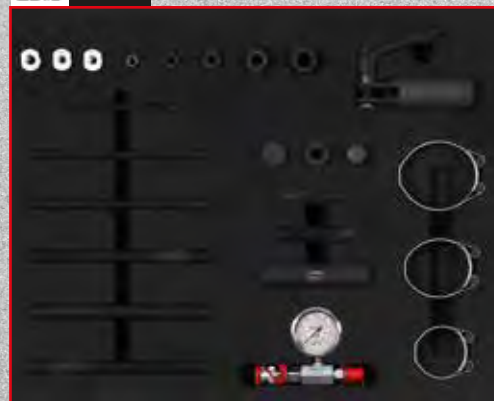

HYDRAULISCHE CILINDER ZONDER BEDIENINGSGEREEDSCHAPPEN



440.9161



3399,90

COMPACTE WIELLAGERS



440.9026



AS



HALVE LEVEN

MODULO 2



P40

EDELSTAHL
ROSTFREI

www.kstools.com

KSTOOLS

Ø 155 mm

1.701 mm

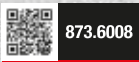

873.6008

PERFORMANCEplus P40 ZWART/ROOD
gereedschapswagen met 4 schuifladen

ZONDER GEREEDSCHAP

2760,50



Meer informatie



4

+

2200 mm

899,90

Hydrauliekpompset
met vak voor P40

440.9004

999,90



440.9076



25

WIELAGERS



76

1999,90



440.9061



26

SCHOKDEMPERS



61

1899,90

i 1
Meer informatie

99,90

max. 8 bar

450 mm

1/4" PT

Voor universele-aandrijfshoezen

515.3100 Pneumatische-asmanchettenspreider

i 1
Meer informatie

100 mm

Ø 30 mm

255 mm

49,90

150.1850 Universele trekker voor cardanassen

i 1
Meer informatie

VA FE

0 - 45 mm

270 mm

39,90

115.1056 Slangklemtang voor moment aanhalen

i 1
Meer informatie

max. 12 mm

49,90

115.1590 Spantang voor RVS-kabelbinders met kogelsluiting

vanaf 25,90

RVS kabelbinders met kogelsluiting

200 - 350 mm

115.1591		100	4,6 × 200 mm	25,90 €
115.1592		100	4,6 × 250 mm	25,90 €
115.1593		100	4,6 × 350 mm	28,90 €
115.1594		100	4,6 × 500 mm	37,90 €

i 1
Meer informatie

10 mm

UNIVERSAL

39,90

700.5662 Spreidgereedschap voor klemboringen

i  **1**
Meer informatie

24,90



1/2"
30 mm

Speciale fuseekogeldop voor Mercedes

150.1721  Mercedes W167, W205, W213, W238, W253, W25



i  **6**
Meer informatie

369,90



KSTOOLS VIBRO-POWER
515.3881
152880316

10 mm
110 mm
10 mm
110 mm
10 mm
130 mm
10 mm
100 x 25 x 12 mm

31x / sec.

VIPRO

515.3880 Vibro-impact pneumatische beitelhamerset

i  **3**
Meer informatie

31,90



10 mm

Klemschroef-uitdrukset

700.5635



i  **1**
Meer informatie

159,90



• trillingsondersteund demonteren van spoorstangen, contraschroefbevestigingen of schroefbevestigingen in de wielophanging enz.
• De speciale trildoorn geeft een impactimpuls aan de los te maken schroefverbinding, waardoor roestvorming vrijkomt en het losmakende proces wordt ondersteund
• Pneumatische beiteladapter (10 mm) voor gebruik met gangbare pneumatische beitelslaghamers

27 mm

290 mm

10 mm

65 mm

150.1608 Vibro-Impact demontagegereedschap voor spoorstangen



Meer informatie



168,90

700.1495 Universele ashefboom met ketting



- door de flexibele ketting kunnen wieldraagarmen van verschillende constructies zonder grote krachtsinspanning veilig naar beneden worden gedrukt



Meer informatie

121,90

- stabiele trapezium schroefdraadspindel
- voetpedaal voor fijninstelling (20 mm)
- de ideale werkplaatskrik in veel situaties



160.0342 Telescopische steun



Meer informatie



89,90

911.6187 Telescoopbreekijzer met zwenkop



Meer informatie

99,90



700.1465 Spelingstester



Meer informatie

MET SNELVERGREDELING



451,90

1000 W

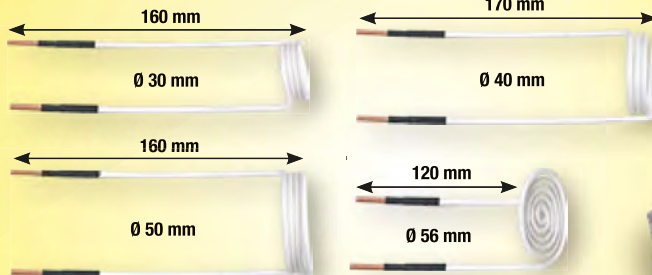

500.8605 Inductie warmtetangset



OPTIONEEL BIJ TE KOPEN

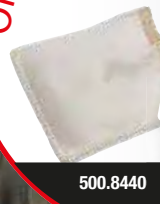

129,90

500.8440

2E GENERATIE - 2E GENERATIE - 2E GENERATIE - 2



Meer informatie

AANHAKEN MAAR!

14,90

NIUW

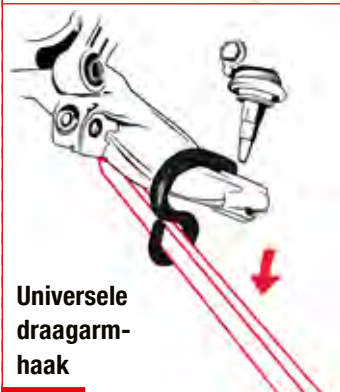
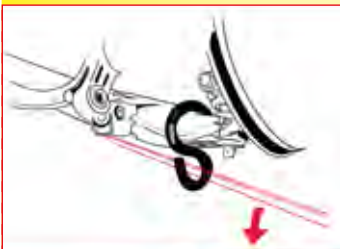

Universele draagarm-haak

700.1499

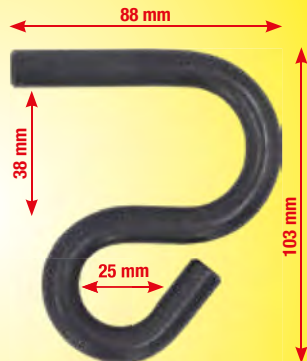

speciale vorm maakt het mogelijk deze zeer dichtbij de wieldraagarm te bevestigen

speciale hefboom voor het vakkundig en zonder beschadigen demonteren en monteren van asdelen



Meer informatie

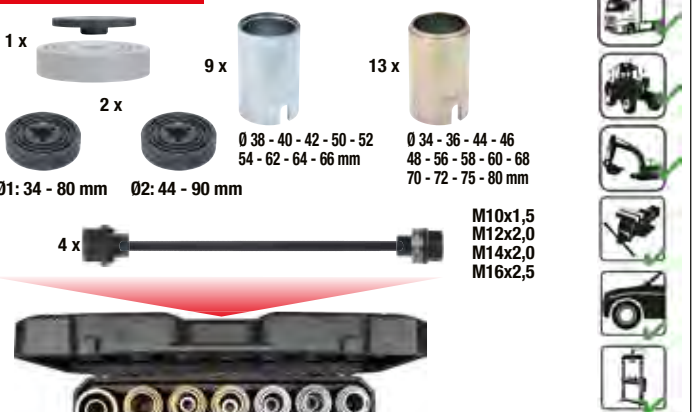

700.1550 Druk- en trekbusset

299,90



i **22**
Meer informatie

42 40 38 36 34
32 30 28 26 24
#1
#2
#3
#4
M12
M10
M12 M10 TR20

700.2355 **Getrapte-drukbusset** **499,90**



i **4**
Meer informatie

79,90

30-35 mm 35-40 mm 40-45 mm
360 mm
1/2" / 32 mm

150.1125 **Speciale sleutelset voor axiaalgewrichten**



i **2**
Meer informatie

M12

NIEUW

115 mm 72 mm

19,90

Bit-dopsleutelset voor veelwand (XZN®)-schroeven, kracht

515.0595 **1/2"**

i **30**
Meer informatie

1 x $\varnothing 90 - 130$ mm
1 x 4 x M14
4 x M12 x 1,25
M12 x 1,5
M12 x 1,25
M12 x 1,5
M14 x 1,5
3 4 5
1 x M18 x 2,5 x 230 mm M57 x 2

4,3 Kg

224,90

700.1530 **Universele wielnaaf- en cardanastrekker**

MINDER PERSONEEL NODIG, MEER WINST.

RUIT LOSMAKEN ZONDER EXTRA HULP!

140.2630

Universeel eenmans uitbouwgereedschap voor ruiten

- ideaal voor het vakkundig en voorzichtig uitbouwen van gelijmde voorruitenevens de meeste achter- en zijruitene
- met grote katrol, waardoor er minder krachtinspanning en minder gevaar op breken van de draad is
- draaddoorvoer direct bij de ruit, daardoor is het in de meeste gevallen niet nodig bekledingsdelen te demonteren
- eenvoudige bediening door een persoon
- bijzonder hoogwaardige zuigpomp voor het betrouwbaar vastzuigen van de ruit



Meer informatie



ONE MAN CUT

NIEUW

Professionele beschermplaatset, 4-dlg
2x 270x200 mm + 2x 450x300 mm

Nylon, 50 m

Omkeerrol

Zuignap Ø 50 mm

Zuignap Ø 50 mm

Snijdraadfixering

4-kant-draad, 50 m

Zuigkracht: 110 kg

Zuignap Ø 150 mm

Zuigkracht: 110 kg

Ontlastingshendel

Snijdraadfixering

Hoogwaardige zuignap

6-kant aandrijving, 30 mm

Zuigkracht: 110 kg

Snijdraad-invoersonde, 290 mm

Omkeerrol

Beschermplaat, gebogen

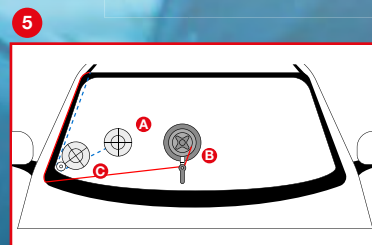
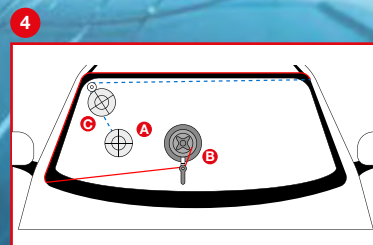
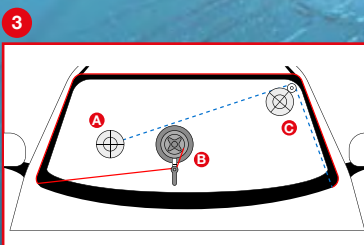
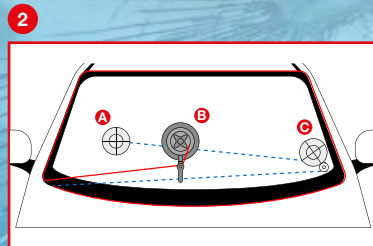
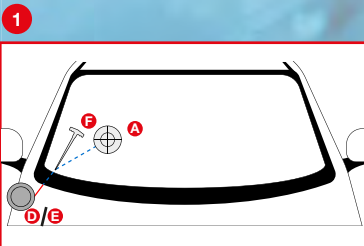

599,90

Inclusief



NIEUW

1
Meer informatie

OOK VOOR DOT5.1, ENV4 EN ENV6

- Dot3 ✓
- Dot4 ✓

0 20 mm

155 mm

14,90

150.1969 Remvloeistoftester voor DOT en ENV

1
Meer informatie

VITON®
EKM

27,90

150.8258 Pompspuitfles voor remmenreiniger

Speciaal voor remmenreiniger

2
Meer informatie

10,90

150.1935 universele haakset, vervormbaar

2
Meer informatie

14,90

150.2235 Universele haakset, star

12
Meer informatie

49,90

150.2400

Speciale dopsleutelset voor remklauwbouten

1/2" 11,5 mm 14 mm 15 mm 20 mm AS 22 mm

1/4" 9 x 20 mm

3/8" 7 x 72 mm
7 x 92 mm
9 x 50 mm
11 x 100 mm

3/8" 7 x 25 - 8 x 25 mm

41
Meer informatie

99,90

150.1970 Gereedschapsset voor het terugstellen van remzuigers



Meer informatie

DE UNIVERSELE GENIE



UNIVERSAL
Voor 95% van alle voertuigen

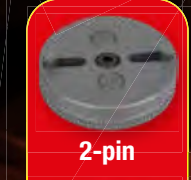

2-pin



3-pin



3/8"



4-pin



129,90



150.2440 Universele gereedschapset voor terugstellen van remzuigers



Meer informatie

699,90



5L



160.0700 Remontluchtapparaat KS5

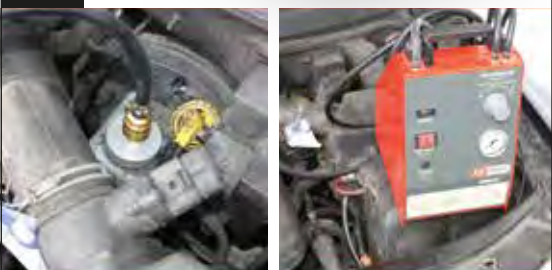

Meer informatie

49,90



universeel verstelbaar



Max. 70 mm

Min. 28 mm

160.0718 Universele adapter voor ontluichtingsaansluiting, verstelbaar



Meer informatie

TOYOTA & LEXUS

NIEUW

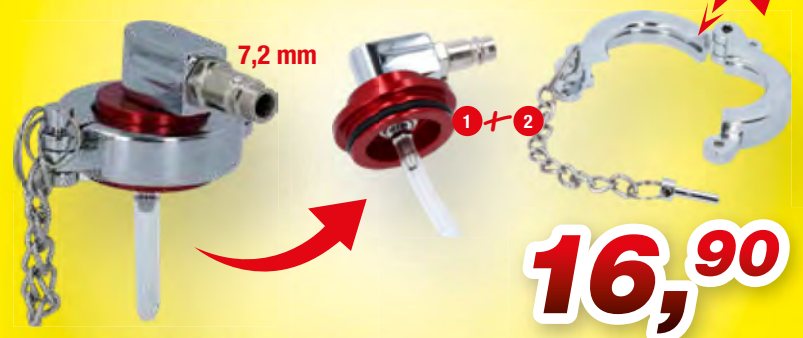

7,2 mm

1+2

16,90

160.0719 Universele ontluichtingsnippel voor Toyota en Lexus

i **6**
Meer informatie

STOP

1.200 mm

11 mm
10 mm
9 mm
8 mm
7 mm

69,90

160.0725 **Remontluchtleutelset**

i **11**
Meer informatie

DE COMPLETE

STOP

1.200 mm

9x12 mm

180 mm

11 mm
10 mm
11 mm
7 mm
11 mm
60 mm
70 mm
75 mm
85 mm

NIEUW

74,90

518.0320 **Remontluchtgereedschapset voor VAG**

i **1**
Meer informatie

4,75 mm (3/16")

21 mm
31 mm
41 mm
61 mm
76 mm

39,90

120.1006 **Remleidingbuig-gereedschap**

i **1**
Meer informatie

4,75 mm (3/16")
6,35 mm (1/4")

29,90

120.1004 **Remleidingrichtgereedschap / -buiggereedschap**

① **Buigen**

② **Dupliceren**

③ **Richten**

OUT IN

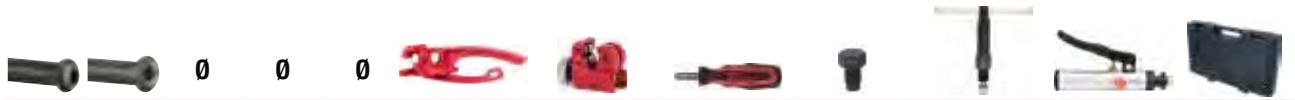

		DIN	SAE	4,75 mm	5,0 mm	6,0 mm	Met pijpbuiger	Met pijpsnijder	Met pijponbramer	mechanisch	Met hydraulische spindel	Handpomp	In de koffer
1	122.1215	✓	✗	✓	✗	✗	✗	✗	✗	✓	✗	✗	✗
2	122.1290	✓	✓	✓	✓	✓	✓	✓	✓	✗	✓	✗	✓
3	122.1260	✓	✓	✓	✓	✓	✗	✗	✗	✗	✗	✓	✓

i
4

Meer informatie

49,⁹⁰

1

FLAREFIXeco 4,75 mm universeel remleiding-felsapparaatset

122.1215

i
16

Meer informatie

FLAREFIX

DIN
SAE

max. 2t

4,75(3/16")
5/8mm

3,0-12,0 mm

3,0-6,0 mm

3,0-16,0 mm

4,75-5,0 mm, SAE

6,0 mm, SAE

4,75-5,0-6,0 mm, SAE-90°

4,75-5,0 mm, DIN

6,0 mm, DIN

M12x1,25

169,⁹⁰

2

FLAREFIX 1 universele felsset voor remleidingen met hydraulische spindel

122.1290

i
11

Meer informatie

HYDRAULISCH, PRAKTISCH, GOED!

FLAREFIX II

Hydraulic

M12 x 1,25 mm

4,75-5,0 mm, SAE

6,0 mm, SAE

4,75-5,0-6,0 mm, SAE-90°

4,75-5,0 mm, DIN

6,0 mm, DIN

M12x1,25

max. 2,5t

4,75(3/16")
5/8mm

5,0 mm

4,75 mm, 3/16"

6,0 mm

299,⁹⁰

3

FLAREFIX 2 universele felsset voor remleidingen met hydraulische cilinder

122.1260

i  **9**
Meer informatie



1 Ford/PSA	2 BMW	3 VAG	4 Mercedes	5 DAF/MAN
6 GM	7 Ford	8 Ford	9 Ford	

24,90

150.1040 Speciale 3/8" olieversersprofielset voor kunststof olieaftappluggen, 9-dlg

i  **6**
Meer informatie



69,90

- Gereedschap voor het vlakken van het contactvlak van carterpanstoppen
- Het vlakken van de zitting waarborgt een goede afdichting van de carterpanstop
- exacte centrering t.o.v. het contactvlak
- Set is inclusief adapter voor originele olie-aftapplug en overmaat schroefdraad-reparatieset
- in stevige kunststof koffer

0° / Ø 22 M14x1,5 M15x1,5

150.1485 Zittingfreeset voor olie-aftappluggen

i  **1**
Meer informatie



Ø 385 mm

12,90

150.9359 Opvangbak 7,5 liter



i  **30**
Meer informatie

1/2" 21 mm
Ø 63 - 102 mm

99,90

3/8"

65-14, 65/67-14, 66-6, 68-14, 73-14, 74-15, 74/76-15, 75/77-15, 76-8, 76-12, 76-14, 76-30, 78-15, 80-15, 80/82-15, 86-18, 86-16, 90-15, 92-10, 93-15, 93-36, 93-45, 95-15, 96-18, 100-15, 106-15, 108-15, 108-18

150.9350 **3/8" Oliefiltersleutelset**



i  **24**
Meer informatie

2,0 L

99,90

VW Lexus Lotus Ford Nissan
Subaru Mitsubishi Land Rover Hyundai Audi
Chrysler Toyota Citroën Volvo Cadillac
Citroën Buick Volvo Buick universeel

150.9130 **MASTER Olievultrechterset met draibare gebogen arm**



i  **4**
Meer informatie

VOOR VAG

met draibare gebogen arm voor moeilijk toegankelijke plekken

2,0 L

14,90

150.9155 **Olievultrechter met draibare arm onder een hoek voor VAG**



OP DE BRUG - KLAAR - AAN HET WERK!

van massief rubber



NIEUW

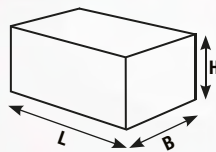

Onderdelen	L mm	B mm	H mm		
160.0476	1	160	120	20	4, ⁹⁰ €
160.0477	1	160	120	30	6, ⁹⁰ €
160.0478	1	160	120	40	8, ⁹⁰ €
160.0479	1	160	120	60	12, ⁹⁰ €
160.0480	1	160	120	80	16, ⁹⁰ €
160.0481	1	160	120	100	20, ⁹⁰ €
160.0482	1	160	120	115	23, ⁹⁰ €
160.0483	1	116,5	116,5	36,5	5, ⁹⁰ €
160.0499	1	160	120	85	17, ⁹⁰ €

PE (polyethyleen)

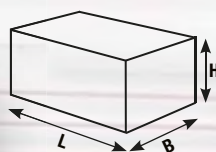

NIEUW



Onderdelen	L mm	B mm	H mm		
160.0437	1	250	150	55	14, ⁹⁰ €
160.0438	1	250	150	100	26, ⁹⁰ €
160.0486	1	340	150	55	19, ⁹⁰ €
160.0489	1	340	130	100	31, ⁹⁰ €



van massief rubber met een versterkte kern



NIEUW

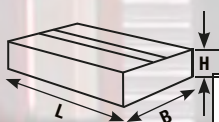

Onderdelen	L mm	B mm	H mm		
160.0484	1	373	100	35	39, ⁹⁰ €



van slagbestendig kunststof



Model 3 ✓
Model S ✓
Model X ✓
Model Y ✓

NIEUW



van massief rubber

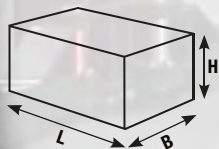

Onderdelen	L mm	B mm	H mm		
160.0391-TD	4	155	125	35	34, ⁹⁰ €



van massief rubber



NIEUW

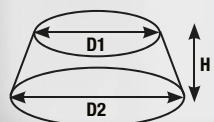

Onderdelen	D1 mm	D2 mm	H mm		
160.0485	1	78	105	60	9, ⁹⁰ €

160.0460 Tesla Model 3, S, X, Y

23,⁹⁰



van rubber en staalplaat

Meer informatie

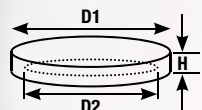

STAAL



	D1 mm	D2 mm	H mm	Ravaglioli	Grazia	OMCN	Intertech	MAHA	Werther	Nussbaum	AMI	Twin Bush	Sirio	Space	Launch	RP Tools	J.A. Becker	ATH	HOFMANN	Hermann		
A	160.0463	120	113	22				✓														8,90 €
B	160.0465	123	108	25	✓				✓													8,90 €
C	160.0475	120	110	19													✓	✓	✓	✓		8,90 €



van rubber

Meer informatie

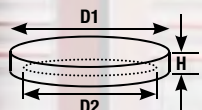

RUBBER



	D1 mm	D2 mm	H mm	Ravaglioli	Grazia	OMCN	Intertech	MAHA	Werther	Nussbaum	AMI	Twin Bush	Sirio	Space	Launch	RP Tools	J.A. Becker	ATH	HOFMANN	Hermann		
A	160.0466	125	120	24						✓	✓											11,90 €
B	160.0467	140	130	25								✓										5,90 €
C	160.0468	100	85	14	✓								✓	✓								4,90 €
D	160.0464	120	113	23				✓														4,90 €
E	160.0469	120	108	32								✓			✓	✓						7,90 €
F	160.0470	150	130	23	✓																	4,90 €
G	160.0471	140	125	30								✓										7,90 €
H	160.0472	130	125	14	✓									✓								6,90 €
I	160.0473	120	105	30								✓	✓	✓								6,90 €
J	160.0474	120	110	19													✓	✓	✓	✓		4,90 €
K	160.0490	100	80	21	✓													✓	✓	✓	✓	3,90 €
L	160.0491	120	108	26	✓	✓																4,90 €
M	160.0492	120	110	26	✓	✓																4,90 €
N	160.0493	145	108	24	✓		✓															7,90 €
O	160.0494	145	135	26	✓																	6,90 €
P	160.0495	160	135	28			✓															6,90 €
Q	160.0496	140	103	25						✓												7,90 €
R	160.0497	150	127	25	✓																	5,90 €
S	160.0498	140	132	28																		8,90 €

i   1
Meer informatie



7,90

**Magneetschaal, kunststof,
Ø 150 mm**

800.0156



i   1
Meer informatie





330 mm

9,90

150.2032 Metalen-ventieltrekker, 330 mm



i   1
Meer informatie



530 mm

27,90

911.8135 Runflat bandenlichter en montagehefboom



i   1
Meer informatie



49,90

800.0190 Magneethouder, metaal, 390 mm



i   1
Meer informatie



600 mm

0 - 12 bar

19,90

515.1950 Bandenspanningsmeter

1/4" PT



i   1
Meer informatie



400 mm

0 - 10 bar

61,90

615.1960 Geijkte bandenspanningsmeter

1/4" PT

GEIJKT



i   5
Meer informatie



56,90

150.1070 Bandvulkaniseerset voor motorvoertuigen, inclusief 100 mm draad

60 x 100 mm

70 g

9 mm

17,90

150.1072

OPTIONEEL BIJ TE KOPEN
60 stuks



i  **1**
Meer informatie

89,90

Slijpset voor aluminium wielnaven
Ø 150 mm, binnen-Ø 90 mm

100.5080

OPTIONEEL BIJ TE KOPEN
34,90
100.5077

VOOR:   **NA:** 

i  **4**
Meer informatie

NIUW

8 mm 10 mm 9 mm 8 mm

Doppenset voor speciale aluminium meerdelige OZ-velgen

14,90

515.0795  

i  **3**
Meer informatie

39,90

1/2" Dopsleutelset, spiraal-profiel kracht, 3-dlg, 17-21 mm

913.1270   17 - 19 - 21 mm

i  **2**
Meer informatie

19,5 mm 21,5 mm 18,5 mm 20,5 mm

Speciale krachtdoppenset voor aluminium-velgen voor Ford, 18,5 / 19,5 / 20,5 / 21,5 mm

27,90

515.0895   18,5 - 19,5 - 20,5 - 21,5 mm

i  **1**
Meer informatie

VOOR MERCEDES

max. 75 Nm

17,90

1/2" Kracht-torsieverlengstuk, 75 Nm

515.1491 



Meer informatie



Slotbout- demontageset



59,90

913.1480 18 - 19 - 20 - 21 - 22 - 23 - 24 - 25 mm



Meer informatie

Velgslotdemontageset



Ø 21,5 mm

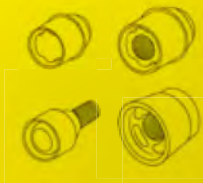

Ø 16 mm



Ø 21,5 mm

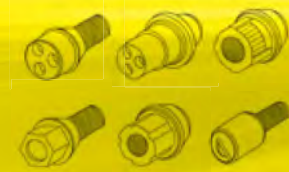

Ø 10,5 mm



Ø 9,5 mm



beide zijden te gebruiken

913.1430



i met handbescherming



14 mm

Schuimstof

139,90



152 mm

Ø 30 mm

143 mm

3x Ø 25 mm

38 mm

1/2"

24 mm



UNIVERSEEL GENIAAL - ZE PASSEN ZICH AAN ELK PROFIEL AAN!

ROBUUSTE 1/2" KRACHTDOPPENSET VOOR ALUMINIUM VELGEN

1

Meer informatie



21 mm 19 mm 17 mm

17,90

515.1070 1/2" 17 - 19 - 21 mm

2

Meer informatie



15 mm 17 mm 19 mm 21 mm 22 mm

24,90

515.0870 1/2" 15 - 17 - 19 - 21 - 22 mm

3

Meer informatie

69,90



17 mm 15 mm 19 mm 22 mm 23 mm 21 mm 17 mm 21 mm 24 mm

1/2" 15 - 17 - 19 - 21 - 22 - 23 - 24 mm

7/8" 17 mm MS21

515.0890

4

Meer informatie



15 mm 17 mm 19 mm 21 mm 22 mm 23 mm 24 mm 17 mm 21 mm

139,90

DE COMPLETE ALLESKUNNER

515.0885 1/2" 15 - 17 - 19 - 21 - 22 - 23 - 24 mm 7/8" 17 mm MS21 17 - 19 - 21 mm 18,5 / 19,5 - 20,5 / 21,5 - 17,5 / 22,5 mm

	515.1072 15 mm	515.1073 17 mm	515.1075 19 mm	515.1076 21 mm	515.1077 22 mm	515.1078 23 mm	515.1079 24 mm	515.1089 Tesla 7/8"	515.2055 Mercedes 17 mm	515.2060 Hyundai KIA MS21	913.1271 Spiraal-uitdraaidop 17 mm	913.1272 Spiraal-uitdraaidop 19 mm	913.1273 Spiraal-uitdraaidop 21 mm	515.0896 Ford 18,5 / 19,5 mm	515.0897 Ford 20,5 / 21,5 mm	515.0899 Ford 17,5 / 22,5 mm	515.1134 Verlengstuk, kracht, 75mm
1	X	✓	✓	✓	X	X	X	X	X	X	X	X	X	X	X	X	X
2	✓	✓	✓	✓	✓	X	X	X	X	X	X	X	X	X	X	X	X
3	✓	✓	✓	✓	✓	✓	✓	✓	✓	✓	X	X	X	X	X	X	X
4	✓	✓	✓	✓	✓	✓	✓	✓	✓	✓	✓	✓	✓	✓	✓	✓	✓

i 1
Meer informatie

Oplaadbaar met USB-C-kabel (inclusief)

16,90

350 Lumen

UV LED

POWER-AREA
Li-Ion
800mAh

165 mm

KSTOOLS
150.4400

Met laserpointer

COB-LED-inspectielamp
350 lumen met UV-spot-LED en laserpointer

150.4400

max. 3 h 3 h IP20

i 1
Meer informatie

14,90

85 Lumen

140 mm

perfectLight zaklamp
85 lumen

25 m

2 x AAA

25 m max. 10 h IPX3

150.4370

i 1
Meer informatie

14,90

DE 'MUST HAVE'!
VOOR WERKPLAATS OF OUTDOOR

MAX. 350 Lumen

MAX. 100 Lumen

270°

USB-C

On/Off

Sensorschakelaar

Li-Ion 3,7 V 1200 mAh

Power Display

Bewegingssensor

XPE LED 2 lichtniveaus

Grootte instelbaar

COB LED 3 lichtniveaus

95 g

max. 8 h 4,5 h

Modi

Modi	COB 100%	COB 40%	COB rot	XPE 100%	XPE 40%
LED	270° 3 Watt COB LED			1 Watt High Power XPE LED	
40%	350 LM	150 LM	-	100 LM	40 LM
	3 h	6 h	8 h	4 h	8 h

On/Off

150.4520

Meer informatie

17,90

360°

250 Lumen

500 Lumen

USB

ON OFF

1200 mAh lithium-ion-accu (inclusief)

of

3 x AAA batterij (wordt niet meegeleverd)

Inclusief USB-powerbank-functie

20 %	●
40 %	●●
60 %	●●●
80 %	●●●●
100 %	●●●●●

150.4510

max. 3 h

3 h

+

IP65

Meer informatie

19,90

130 Lumen

300 Lumen

ON OFF

USB-A OUT

USB-C IN

Geïntegreerde lithium-ion-accu 1.200 mAh

20 %	●
40 %	●●
60 %	●●●
80 %	●●●●
100 %	●●●●●

150.4505

max. 3 h

3 h

+

IP65

Meer informatie

16,50

60 Lumen

150 Lumen

Micro USB

ON OFF

360°

180°

20 %	●
40 %	●●
60 %	●●●
80 %	●●●●
100 %	●●●●●

150.4495

max. 3,5 h

2,5 h

IP20

Meer informatie

37,50

250 Lumen

550 Lumen

ON OFF

USB-A OUT

USB-C IN

Geïntegreerde lithium-ion-accu 1.200 mAh

20 %	●
40 %	●●
60 %	●●●
80 %	●●●●
100 %	●●●●●

150.4490

max. 3,5 h

3 h

+

IP65

i  **11**
Meer informatie



20-200 Nm

met Keurmerk
DIN EN ISO 6789
Certificaat
Nauwkeurigheid

119,90

516.2400 1/2" 10 - 13 - 17 - 19 - 21 - 24 mm

125 mm

10 mm 13 mm 17 mm 19 mm 21 mm 24 mm

17 mm 19 mm 21 mm

500 mm

1/2"

KALIBER-KONFORMITÄTSERKLÄRUNG

THE DEVIL

i  **8**
Meer informatie

VOOR BANDENWISSEL IN RECORDTEMPO

1600 Nm

2 x Ø 150 mm

0 - 12 bar

10 m

119,90

NIEUW

Uw dealer

 **4 042146 956625**

LL23-06NL_EUR

KS Tools Werkzeuge - Maschinen GmbH
Seligenstädter Grund 10 - 12
D-63150 Heusenstamm
Mail: aftersales@kstools.com
Web: www.kstools.com

DUITSLAND

515.2100

Met het verschijnen van deze folder komen alle voorgaande actiepijzen te vervallen. Verkoop alleen via de vakhandel. Druk- en zetfouten, technische veranderingen en fouten voorbehouden. Alle prijzen in EUR excl. BTW, geldig tot 30-09-2024.