

Universāla dzinēja balsttraversa

Preces Nr.: 160.0090
 EAN: 4042146365632
 Speciāla cena: €430,50 *



Apraksts

- ļoti elastīgs, pateicoties bīdāmai un elastīgai konstrukcijai ar gultņiem
- universāls pielietojums
- vienkārša lietošana un ātra montāža
- garenvirzienā bīdāms un grozāms āķis
- aizsargdisks ar regulējamu augstumu un neslīdošu uzliktni
- drošs balsts dzinējam un transmisijai
- pateicoties montāžai no apakšas, var ērti piekļūt dzinēja telpai
- speciālais instrumentu tērauds







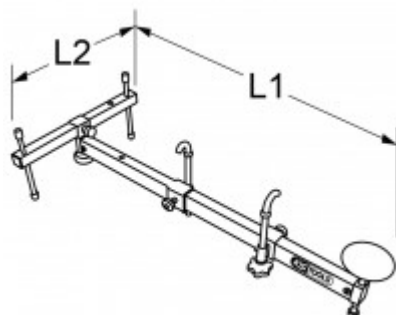









Pielietojuma jomas / paredzēts: zobsiksna maiņa, sajūga maiņa utt.



Īpašības

Augstums H:	300,0
Daļas garums L2 mm:	510
Funkciju atribūti 1:	regulējams
Iesaiņojuma augstums, mm:	152
Iesaiņojuma garums, mm:	1041
Iesaiņojuma platums, mm:	156
Materiāls 1:	Speciāls instrumentu tērauds
Pielietojuma joma - vispārīga:	universal
kopējais garums L1, mm:	1020
krāsa:	sudraba
svars, g:	1070



Rezerves daļas

Preces Nr.	Skaitis		Prece	Ieteicamā mazumtirdzniecības cena: (neskaitot PVN)
160.0090-R001P	1 x		Šķērsbalsts	€159,53 *
160.0090-R002P	2 x		Aizsarguzliktnis	€34,40 *
160.0090-R003P	2 x		Tapa	€37,12 *
160.0090-R004P	2 x		Cepuruzgrieznis M14	€8,33 *
160.0090-R005P	1 x		Šķērsbalsta savienojums	€70,45 *
160.0090-R006P	3 x		Zvaigžņveida rokturis ar ārējo vītņi	€22,34 *
160.0090-R007P	1 x		Paplāksne	€1,84 *
160.0090-R008P	1 x		Zvaigžņveida roktura uzgrieznis	€21,29 *
160.0090-R009P	1 x		Pamatkorpuss	€381,15 *
160.0090-R010P	1 x		Skrūve, M6	€1,84 *
160.0090-R011P	1 x		Gumijas paklājīņš	€146,74 *
160.0090-R012P	1 x		Uzgrieznis, M16	€3,79 *
160.0090-R013P	1 x		Spārniņu uzgrieznis	€25,96 *
160.0090-R014P	2 x		Slīdelements	€125,18 *
160.0090-R015P	2 x		Āķis	€54,76 *
160.0090-R016P	2 x		Spīlgredzens	€24,14 *

160.0090-R017P	2 x		Bezgalvas skrūve	€5,60 *
160.0090-R018P	2 x		Paplāksne	€4,70 *
160.0090-R019P	2 x		Zvaigžņveida roktura uzgrieznis M16	€68,64 *