

## Serie di chiavi p.dadi+cappucci Vario,esecuzione pesante,14 pz

N. articolo: 450.0190

EAN: 4042146327128

Prezzo di vendita consigliato: 921,58 € \*

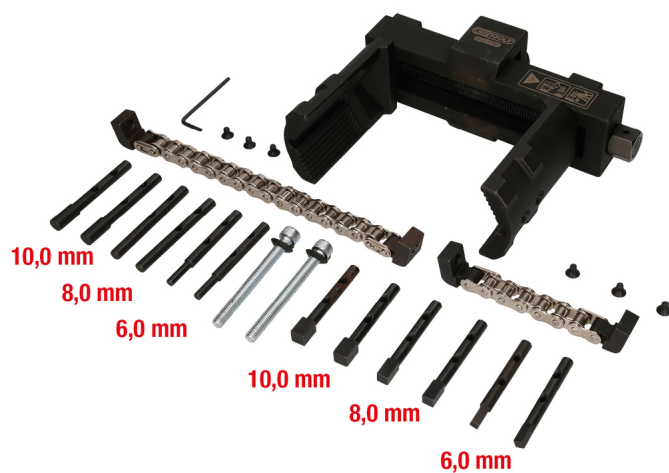

### Descrizione

- Versione extrapesante
- Per montaggio e smontaggio di dadi Vario
- Possibilità di serraggio controllato con chiave dinamometrica quadro di manovra 3/4"
- Tenuta sicura grazie alle viti di bloccaggio e alla guida adattatore sull'utensile di base
- Distanza tra scanalature e fori max. 145 mm
- Incluso tendicatena
- Versione sottile
- Utilizzabile per posizioni di difficile accesso
- Impiego ideale su dadi speciali e cappucci
- Acciaio speciale per utensili









**Campi d'applicazione:** ghiera e dadi cilindrici esagonali e ottagonali.

### Caratteristiche

Altezza imballaggio mm:	96
Larghezza imballaggio mm:	248
Lunghezza imballaggio mm:	291
Materiale 1:	Acciaio speciale per utensili
Peso in g:	4800
Pezzi per serie:	14



**Composto da:**

N. articolo	Numero		Articolo	Prezzo di vendita consigliato: (escl. I.V.A.)
450.0191	1 x		Chiave p.dadi e cappucci Vario	835,54 € *
450.0192	1 x		Adattatore rotondo,6mm,cf.da 2	77,42 € *
450.0193	1 x		Adattatore rotondo,8mm,cf.da 2	77,42 € *
450.0194	1 x		Adattatore rotondo,10mm,cf.da 2	77,42 € *
450.0195	1 x		Adattatore quadro,6mm,cf.da 2	83,68 € *
450.0196	1 x		Adattatore quadro,8mm,cf.da 2	83,68 € *
450.0197	1 x		Adattatore quadro,10mm,cf.da 2	83,68 € *
450.0198	1 x		Tendicatena	310,75 € *