



Mini-smerigliatrice angolare pneumatica SlimPOWER, stelo lungo, 18.000 giri/min

N. articolo: 515.5540

EAN: 4042146756256

Prezzo di vendita consigliato: 378,48 € *

Descrizione

- Versione angolare
- Scarico dell'aria dall'impugnatura
- Utilizzo con una sola mano, design ergonomico
- Per frese HM, mini mole a troncatura e mole in pietra con gambo di 6 mm
- Ideale per lavori di levigatura, lucidatura e incisione
- Per lavorazioni in spazi angusti
- Con regolazione continua della velocità
- Protezione dalle vibrazioni
- Per dimensioni ridotte
- In dotazione raccordo ad innesto da 1/4"
- Carter robusto

Caratteristiche



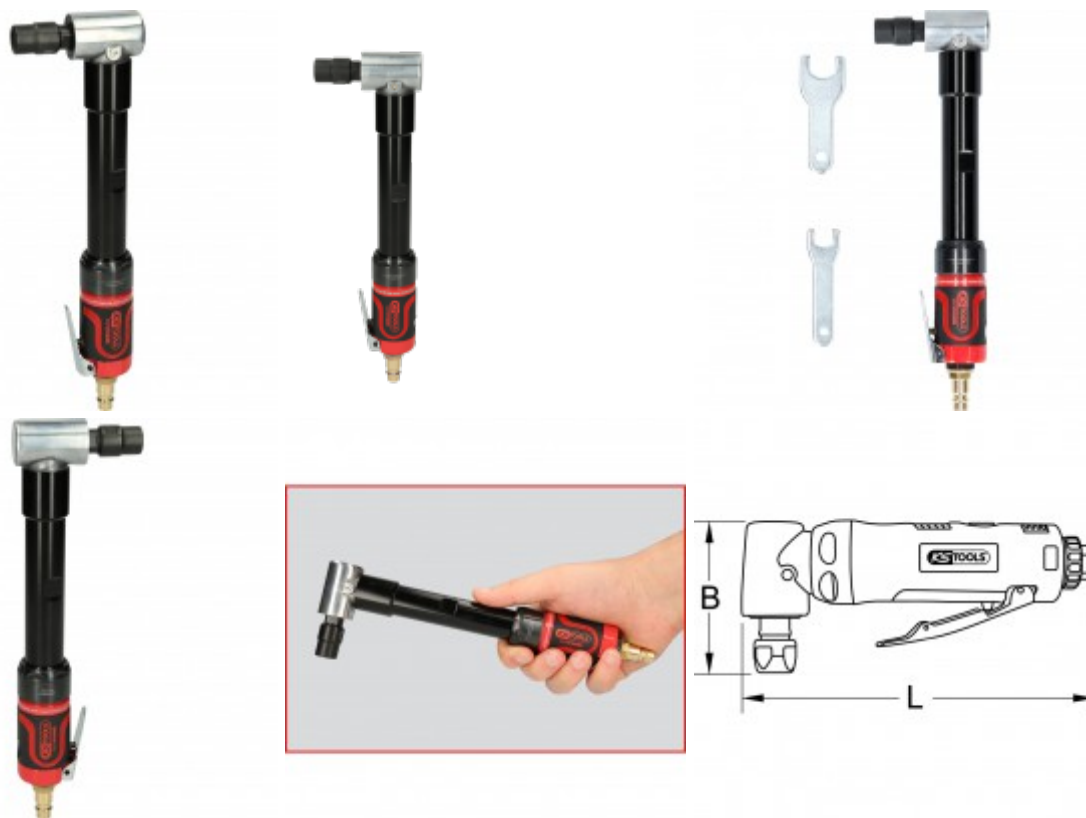















Accelerazione vibrazioni:	< 6,5
Altezza imballaggio mm:	55
Attacco filettato:	1/4"NPT
Attributi funzione 1:	Arresto di sicurezza
Consumo d'aria in l/min:	283
Contenuto della confezione:	1
Diametro min. del tubo dell'aria:	3/8" - 10 mm
Forma:	Angolato
Imprecisione di misurazione accelerazione vibrazioni:	1.14
Larghezza B:	70
Larghezza imballaggio mm:	94
Livello di potenza sonora (dB(A)):	97.8
Livello di pressione acustica (dB(A)):	86.8
Lunghezza imballaggio mm:	265
Lunghezza totale L in mm:	270.0
Mandrino di serraggio:	6
Modalità di funzionamento:	Pneumatico
Norma:	DIN EN ISO 28927-3
Peso in g:	700
Potenza in Watt:	220 Watt
Pressione di esercizio in bar:	max. 6,3 bar (90 psi)
Velocità a vuoto in giri/min:	18000



Pezzi di ricambio

N. articolo	Numero	Articolo	Prezzo di vendita consigliato: (escl. I.V.A.)
515.5410-R003P	1 x	 Bussola di serraggio	11,39 € *
515.5410-R013P	2 x	 Pala rotore	2,04 € *
515.5410-R016P	1 x	 Cuscinetto a sfere	15,40 € *
515.5415-R003P	1 x	 Cuscinetto a sfere	15,93 € *
515.5420-R001P	1 x	 Dado bussola di serraggio	14,33 € *
515.5420-R003P	1 x	 Vite di carico	1,77 € *
515.5420-R006P	1 x	 Alberino ingranaggi	36,36 € *

515.5420-R007P	1 x		Cuscinetto a sfere	15,40 € *
515.5420-R014P	1 x		Chiave per viti	4,58 € *
515.5475-R007P	1 x		Cuscinetto a sfere	15,40 € *
515.5505-R001P	1 x		Tappo di chiusura	3,66 € *
515.5505-R002P	1 x		O-Ring	1,32 € *
515.5505-R003P	1 x		Molla	1,32 € *
515.5505-R004P	1 x		O-Ring	1,32 € *
515.5505-R005P	1 x		Perno della valvola	2,88 € *
515.5505-R006P	1 x		O-Ring	1,32 € *
515.5505-R007P	1 x		Bussola della valvola	4,44 € *
515.5505-R008P	1 x		Bussola ingresso aria	7,94 € *
515.5505-R009P	1 x		Deflettore di scarico	1,98 € *
515.5505-R010P	1 x		Silenziatore	1,32 € *
515.5505-R011P	1 x		O-Ring	1,32 € *
515.5505-R012P	1 x		Leva di azionamento	3,15 € *
515.5505-R013P	1 x		Perno di sollevamento	0,93 € *
515.5505-R014P	1 x		Alloggiamento azionamento	37,25 € *
515.5505-R015P	1 x		Alloggiamento cuscinetto a sfere posteriore	15,86 € *

515.5505-R016P	1 x		Alloggiamento rotore	15,86 € *
515.5505-R017P	1 x		Pin	0,93 € *
515.5525-R009P	1 x		Alloggiamento testa angolata	31,54 € *
515.5525-R010P	1 x		Passacavo filettato nell'alloggiamento	9,88 € *
515.5530-R001P	4 x		Pala rotore	1,98 € *
515.5530-R002P	1 x		Rotore	19,74 € *
515.5530-R003P	1 x		Rotore anello filettato	1,45 € *
515.5530-R004P	1 x		Piastra anteriore di chiusura	8,84 € *
515.5530-R005P	1 x		Cuscinetto a sfere	11,06 € *
515.5530-R010P	1 x		Chiave a nastro	3,29 € *
515.5535-R001P	1 x		Pignone ruota dentata	35,43 € *
515.5535-R002P	1 x		Coperchio alloggiamento	17,78 € *
515.5535-R003P	1 x		Vite di pressione	23,76 € *
515.5540-R001P	1 x		Dado	3,92 € *
515.5540-R002P	1 x		Passacavo filettato nell'alloggiamento	9,88 € *
515.5540-R003P	1 x		Dado	3,92 € *
515.5540-R004P	1 x		Rondella	1,32 € *
515.5540-R005P	1 x		Alberino di prolunga	39,32 € *

515.5540-R006P

1 x



Prolunga alloggiamento

59,04 € *