

Univerzalni set alata za podešavanje motora, 20-delni

Br. artikla: 400.0150

EAN: 4042146424933

Posebna Cijena: 212,00 € *



Opis

- za profesionalne popravke motora
- za blokiranje kolenastog vratila ili bregastih osovina
- za zamenu zupčastog kaiša
- i za blokiranje Twin-Cam duplih bregastih osovina
- veoma visoka preciznost
- u stabilnom koferu od čeličnog lima

Oblasti primene / za: univerzalno primenljivo za brojna vozila, naročito **Audi, Citroën, Ford, Honda, Land Rover, Mazda, MG, Peugeot, Rover, Opel** sa benzinskim i dizel motorima sa pojedinačnim i duplim bregastim osovinama

Svojstva







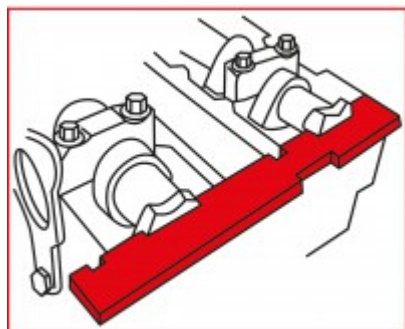



Dužina pakovanja mm:	410
Visina pakovanja mm:	48
delovi u setu:	20
oblast primene:	univerzalno
sadržaj pakovanja:	1
težina u g:	1377
Šifra motora Audi:	AFB, AKE, AKF, AKN, AYM, BAU, BCZ, BDG, BDH, BFC
Šifra motora Chrysler:	EDJ
Šifra motora Ford:	ALDA, AZBA, AZBC, AZWA, BHPA, BOA, BOB, BRC, BRG, BRT, B4A, B4T, C9DC, EDBB, EDBD, EDDB, EDDC, EDDD, EDDF, EYDB, EYDC, EYDF, EYDG, EYDI, EYDJ, EYDL, EYPA, EYPC, E5FA, E5FC, E5SA, E5SB, FFBA, FFDA, FFWA, FXFA, G6DA, G6DB, G6DC, G6DD, G6DE, G6DF, G6DG, HCPA
Šifra motora Honda:	20T2N, 20T2R
Šifra motora LDV:	4EB, 4HB
Šifra motora PSA:	C1A, HAZ (TU1CP), HFV (TU1A), HFX (TU1A), HFX (TU1JP), H1A, KDY (TU3FM), KFT (TU3A), KFU (ET3J4), KJV (TU3A), KVV (TU3JP), KFW (TU3A), KFX (TU3JP), K1F, K1G, K2A, K2B, K2D, K3A, K9A (TUD3), K9Y (TUD3Y), M4A, NFR (TU5JP4B), NFS (TU5JP4S), NFU (TU5JP4), NFZ
Šifra motora Rover:	XUD 7TE, 20 T2N
Šifra motora Volkswagen:	AAF, ACU, AET, AFB, AGX, AHD, AKN, ANJ, APA, APL, AVR, AVT, BAU, BBE, BBF, BDG, BDH
Širina pakovanja mm:	185





* U sve cijene dodan je zakonom propisani porez na dodanu vrijednost.

Prodaja samo preko registriranih prodavača.



Sastoji se od

Br. artikla	Količina	Artikl	Preporučena maloprodajna cijena: (bez PDV-a)
400.0151	1 x	 Alat za blokiranje bregaste osovine, 60 x 32 x 14 mm	Info: artikl nije dostupan za narudžbu
400.0152	1 x	 Alat za blokiranje bregaste osovine, 70 mm	Info: artikl nije dostupan za narudžbu
400.0153	1 x	 Četvorougli ključ za zatezače, 8,0 mm	Info: artikl nije dostupan za narudžbu
400.0154	1 x	 Lenjir za podešavanje bregaste osovine, 200 mm	Info: artikl nije dostupan za narudžbu
400.0155	1 x	 Zaporni trn za kolenasta vratila Ø 5 mm	Info: artikl nije dostupan za narudžbu
400.0156	1 x	 Zaporni trn za kolenasta vratila Ø 6,0 mm	Info: artikl nije dostupan za narudžbu
400.0157	1 x	 Zaporna igla za zamajac Ø 10,0 mm, kratka (2)	6,00 € *
400.0158	1 x	 Fiksirni trn za kolenasto vratilo (2) Ø 8,5 mm	Info: artikl nije dostupan za narudžbu
400.0159	1 x	 Zaporni trn za kolenasto vratilo	Info: artikl nije dostupan za narudžbu
400.0160	1 x	 Alat za podešavanje bregaste osovine (2), 38 x 44 mm	Info: artikl nije dostupan za narudžbu
400.0161	1 x	 OT fiksirni trn za kolenasto vratilo, 102 mm	Info: artikl nije dostupan za narudžbu

400.0162	1 x		Mehanizam za blokiranje bregaste osovine za Opel / Saab, plavi	Info: artikl nije dostupan za narudžbu
400.0163	1 x		Mehanizam za blokiranje bregaste osovine za GM / Opel, zlatni	Info: artikl nije dostupan za narudžbu
400.0164	1 x		Zaporni trn Ø 6,6 mm (2)	Info: artikl nije dostupan za narudžbu
400.0165	2 x		Trn za fiksiranje bregaste osovine 5,0 mm	Info: artikl nije dostupan za narudžbu