



Mini-meuleuse d'angle pneumatique SlimPOWER, 18.000 Tr/min

No de l'article : 515.5540

EAN : 4042146756256

Prix promotionnel: 184,00 € *

Description

- Version coudée
- Sortie d'air par la poignée
- Design ergonomique pour un travail à une main
- Pour fraises HM, mini disques à tronçonner et disques à meuler avec manche 6 mm
- Pour les travaux de ponçage, de polissage et de gravure
- Pour le travail dans des endroits exigus
- Réglage de vitesse continu
- Système d'atténuation des vibrations
- Construction compacte
- Livrée avec un connecteur de raccord 1/4"
- Boîtier robuste

Caractéristiques



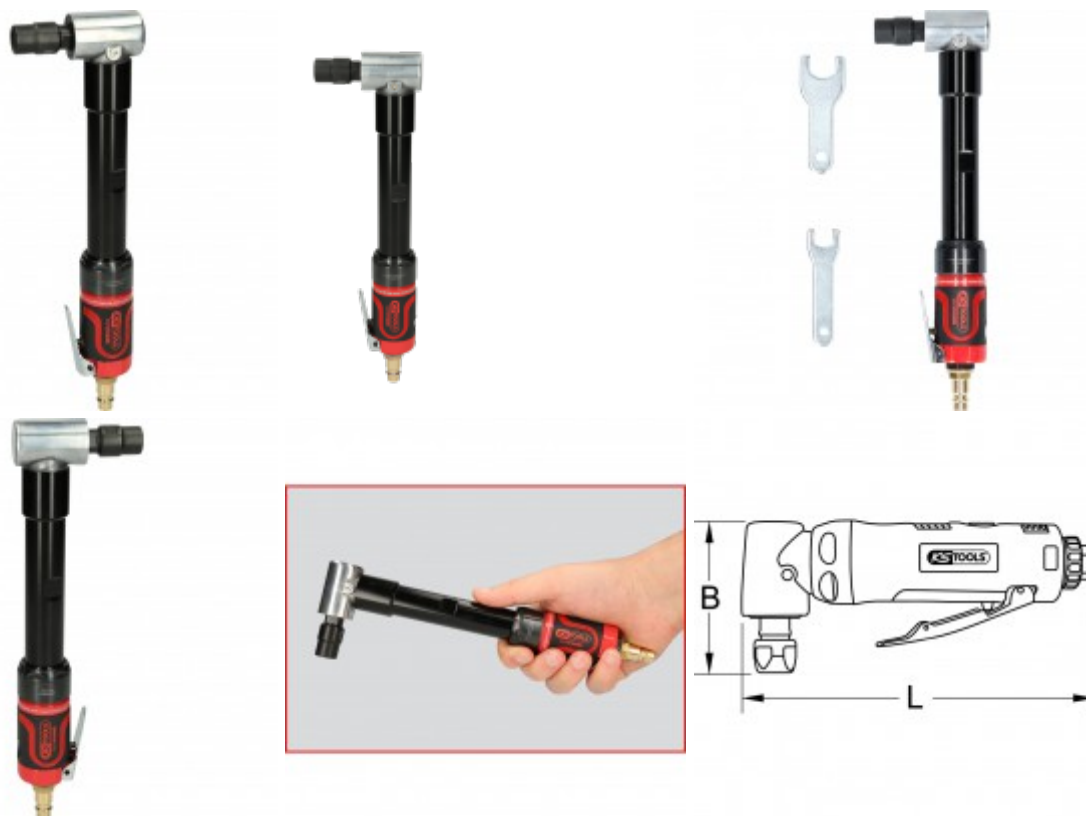















Attribut de fonction 1:	Verrouillage de sécurité
Bruit max en sollicitation:	86.8
Bruit max à vide:	97.8
Consommation d'air:	283
Contenu (QPKI):	1
Diamètre minimum du tuyau:	3/8" - 10 mm
Filetage de raccord:	1/4"NPT
Forme:	En angle
Hauteur de l'emballage en mm:	55
Inexactitude de mesure accélérateur de vibrations:	1.14
Largeur B:	70
Largeur de l'emballage en mm:	94
Longueur de l'emballage en mm:	265
Longueur totale L en mm:	270.0
Mandrin:	6
Mode de fonctionnement:	pneumatique
Norme:	DIN EN ISO 28927-3
Poids en g:	700
Pression de service:	max. 6,3 bar (90 psi)
Puissance en Watt:	220 Watt
Vibrations:	< 6,5
Vitesse de rotation à vide en T/mn:	18000



Pièces de rechange

No de l'article	Quantité	Article	Prix de détail recommandé: (hors TVA.)
515.5410-R003P	1 x	 Douille de blocage	11,39 € *
515.5410-R013P	2 x	 Pale de rotor	2,04 € *
515.5410-R016P	1 x	 Roulement à billes	15,40 € *
515.5415-R003P	1 x	 Roulement à billes	15,93 € *
515.5420-R001P	1 x	 Écrou de douille de blocage	14,33 € *
515.5420-R003P	1 x	 Broche d'entraînement	1,77 € *
515.5420-R006P	1 x	 Broche de transmission	36,36 € *

515.5420-R007P	1 x		Roulement à billes	15,40 € *
515.5420-R014P	1 x		Clé à molette	4,58 € *
515.5475-R007P	1 x		Roulement à billes	15,40 € *
515.5505-R001P	1 x		Couvercle d'obturation	3,66 € *
515.5505-R002P	1 x		Joint torique	1,32 € *
515.5505-R003P	1 x		Ressort	1,32 € *
515.5505-R004P	1 x		Joint torique	1,32 € *
515.5505-R005P	1 x		Goupille de soupape	2,88 € *
515.5505-R006P	1 x		Joint torique	1,32 € *
515.5505-R007P	1 x		Douille de soupape	4,44 € *
515.5505-R008P	1 x		Bague d'entrée d'air	7,94 € *
515.5505-R009P	1 x		Défecteur d'air d'échappement	1,98 € *
515.5505-R010P	1 x		Silencieux	1,32 € *
515.5505-R011P	1 x		Joint torique	1,32 € *
515.5505-R012P	1 x		Levier de commande	3,15 € *
515.5505-R013P	1 x		Boulons de levier	0,93 € *
515.5505-R014P	1 x		Boîtier de transmission	37,25 € *
515.5505-R015P	1 x		Logement de roulement à billes arrière	15,86 € *

515.5505-R016P	1 x		Boîtier de rotor	15,86 € *
515.5505-R017P	1 x		Broche	0,93 € *
515.5525-R009P	1 x		Boîtier de tête d'angle	31,54 € *
515.5525-R010P	1 x		Boulonnage de boîtier	9,88 € *
515.5530-R001P	4 x		Pale de rotor	1,98 € *
515.5530-R002P	1 x		Rotor	19,74 € *
515.5530-R003P	1 x		Bague filetée de rotor	1,45 € *
515.5530-R004P	1 x		Panneau de fermeture avant	8,84 € *
515.5530-R005P	1 x		Roulement à billes	11,06 € *
515.5530-R010P	1 x		Clé de serrage	3,29 € *
515.5535-R001P	1 x		Pignon de couronne dentée	35,43 € *
515.5535-R002P	1 x		Couvercle de boîtier	17,78 € *
515.5535-R003P	1 x		Broche	23,76 € *
515.5540-R001P	1 x		Écrou	3,92 € *
515.5540-R002P	1 x		Boulonnage de boîtier	9,88 € *
515.5540-R003P	1 x		Écrou	3,92 € *
515.5540-R004P	1 x		Rondelle	1,32 € *
515.5540-R005P	1 x		Broche d'extension	39,32 € *

515.5540-R006P

1 x



Extension de boîtier

59,04 € *