

DEAL

TIPS

KS TOOLS

HD

Ø 3,9 mm

± 210°
Kontrollerbar

6 dimmbara
mini-LED-lampor

1.000 mm
50 mm

720° PERFEKT PANORAMAUTSIKT!
FULL KONTROLL I FYRA RIKTNINGAR!

720°

vridbar
vridbar
360°

IP 67

AVI
1920 x 1080

JPG

3000 mAh
Li-polymer

microSD

USB-C

-10°/+70°C

150 min

30 mm

70°

32 GB



35 mm
60 mm

20 mm
30 mm

3,9 mm
25 - 100 mm

max. 210°

1 2 3 4

NÄR VISION MÖTER PRECISION!

8270,-

Mer information

550.7580

HD-VIDEOSKOP-SATS MED Ø 3,9 MM 720° OCH 0°
HD FRONTKAMERA-SOND, FLEXIBELT PVC-HÖLJE

Alla priser i SEK exklusive moms gäller tills 2026-09-30

PERFORMANCE I TVÅ PAKET!

VILKET ÄR DITT PERFORMANCE-PAKET?

P10

EDELSTAHL
ROSTFREI

Mer information  397 

527 mm

1.026 mm

853 mm

Ø 125 mm

40160,-

810.7397 P10 verktygsvagn med 397 verktyg

P15

Mer information  397 

510 mm

1.025 mm

840 mm

Ø 125 mm

41590,-

815.7397 P15 verktygsvagn med 397 verktyg

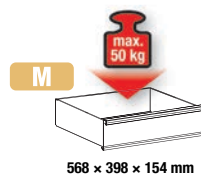
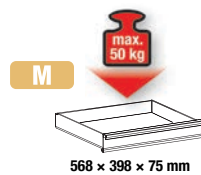
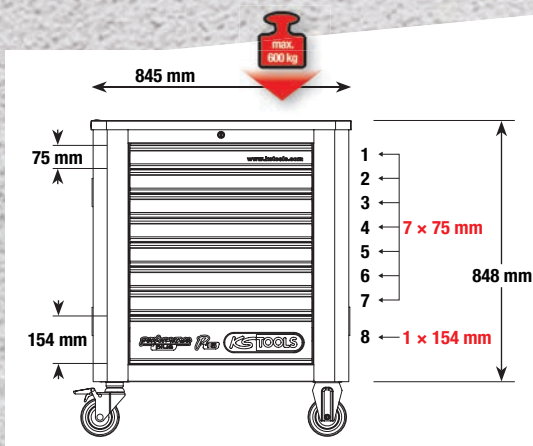

**VERKSTADSVAGN
MED 397 VERKTYG I VARJE**

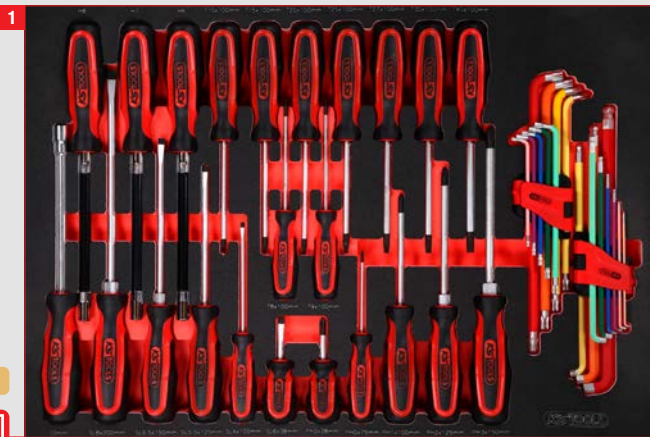

M
41

Skruvmejsel-sats



M
111

1/4" + 3/8" + 1/2" insticksnyckel-sats

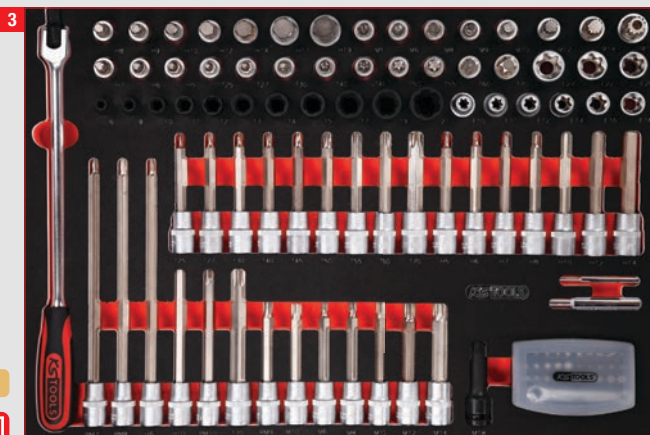

M
111

1/2" bits sockelsats



M
41

Skruvnyckelsats



M
28

Tång- och filset



M
43

Servicesats för olja och däck



M
22

Hammar- och mejselsats

**performance
plus**

**P
25**

564
Mer information

56570,-

825.8564 P25 verktygsvagn med 564 verktyg

1 0
OPTION
1 0



integrerat kantskydd



antistatiska hjul med broms



med Burkhällare



lås som kan låsas



stabil kullager

1 0
OPTION
1 0

1 / 0
Option

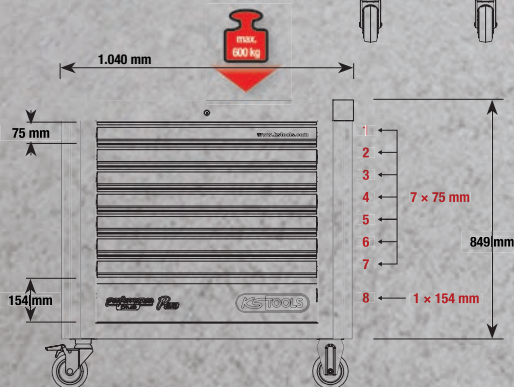
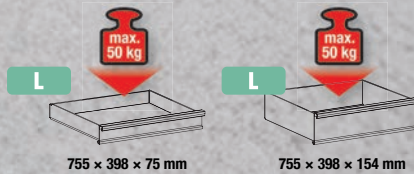
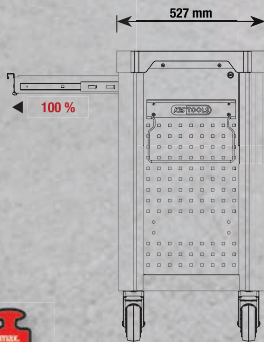

660
Mer information

68540,-

825.8660 P25 verkstadsvagn med 660 verktyg

MED 564 VERKTYG

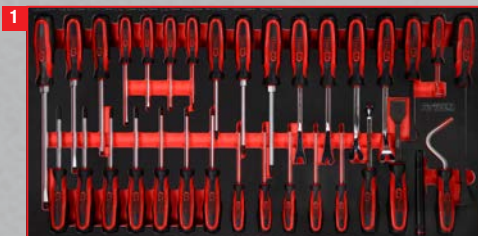

Skruvmejsel-sats

L

TLG
33



1/4" + 3/8" insticksnyckel-sats

L

TLG
213



T-handtag-vinkelstiftnyckel- och filsetsats

L

TLG
28



3/8" insticksnyckel-sats

L

TLG
165



MED 660 VERKTYG



1/2" insticksnyckel-sats

L

TLG
86



Skruvnyckelsats

L

TLG
57



Skruvnyckelsats

L

TLG
54



1/2" insticksnyckel-sats

L

TLG
120



Skruvnyckelsats

L

TLG
57



Skruvnyckelsats

L

TLG
68



Skruvmejsel- och filset

L

TLG
42



Hammar-, mejsel- och kraftuttagsats

L

TLG
40



Tång- och mätverktyg-sats

L

TLG
39

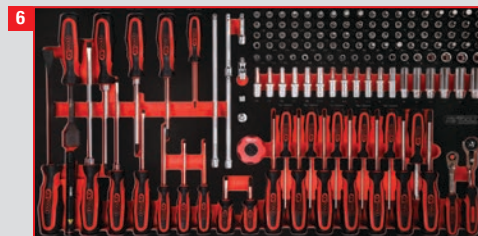

1/4" hylsnyckel- och skruvmejselsats

L

TLG
146

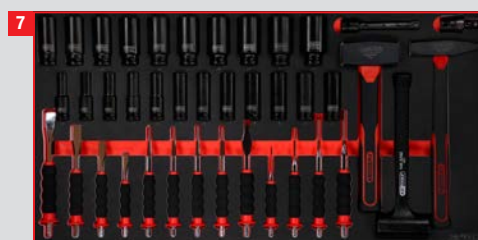

Hammar-, mejsel- och kraftuttagsats

L

TLG
40



Tång- och mätverktyg-sats

L

TLG
36

DAGS FÖR EN NY BIL?

ECO *Line*



897.0007

UTAN VERKTYG

Mer information

6680,-

Tekniska data:	Eco Line 897.0007	Racing Line 826.0007
Total dragkraft:	300,0 kg	350,0 kg
Lastkapacitet på varje låda:	25,0 kg	30,0 kg
självindrag och SOFT-CLOSE-funktion:	✓	✗
hjul diameter:	125,0 mm	125,0 mm
Ljullås:	✓	✓
Med central förregling:	✓	✓
enskilt lås:	✗	✓
Höjd:	1014,0 mm	976,0 mm
Bredd:	748 mm	788 mm
Djup:	459,0 mm	496,0 mm
Innermått låda:	565 x 395 mm	565 x 395 mm
med polyuretan i hörn- och kantskydd:	✗	✓
Fyrkantöppning för tillbehörsdelar:	✓	✓
Antal lådor:	7	7
plättjocklek:	0,8 mm	0,9 mm
handtag:	✓	✓
Expansionsbeslag för låda:	100 %	90 %
arbetsplatta med fack för smådelar:	✗	✓
Bänkskiva med skuminlägg:	✓	✗
Lådstyrning med kullager:	✓	✓
med metallhandtag på sidan:	✓	✓



Arbetsplatta med 10 mm tjockt skumplastinlägg

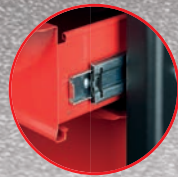

med självindrag och SOFT-CLOSE-funktion

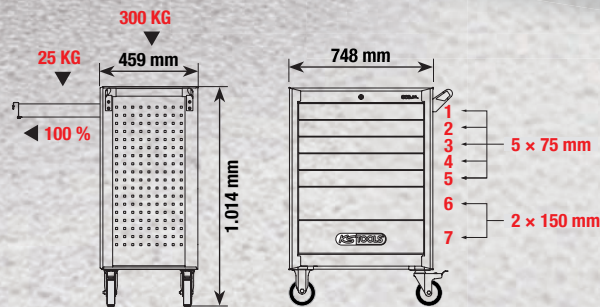

RACING *Line*



826.0007

UTAN VERKTYG

Mer information

7450,-



Arbetskiva av ABS med fack för smådelar

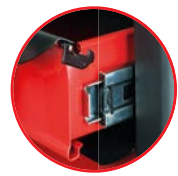

Separat låsning förhindrar oönskad öppning

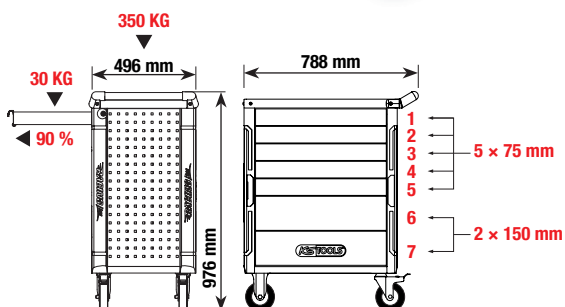

ECO *line*

Med sju lådor och
215-delars premiumverktyg

10110,-

897.7215

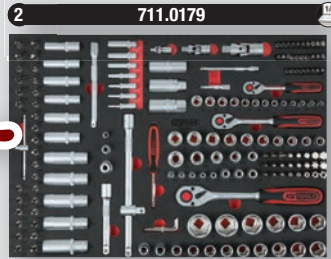
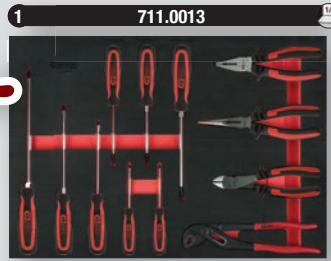

STARTPAKET - 215 DELAR

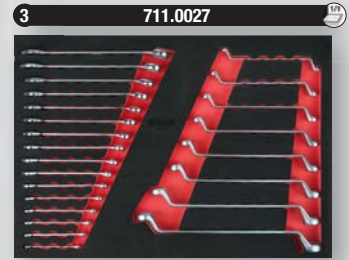

Mer information

RACING *line*

Med sju lådor och
215-delars premiumverktyg

10400,-

826.7215



ECO *line*

Med sju lådor och
515-delars premiumverktyg

13050,-

897.7515



UNIVERSALPAKET - 515 DELAR

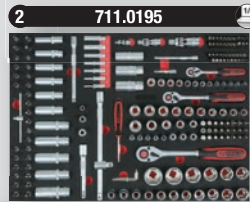
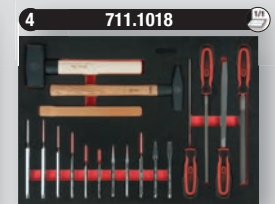
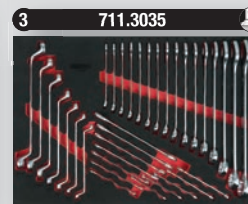

Mer information

RACING *line*

Med sju lådor och
515-delars premiumverktyg

13410,-

826.7515



ECO *line*

Med sju lådor och
598-delars premiumverktyg

19350,-

897.7598

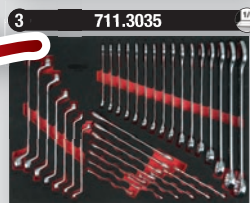
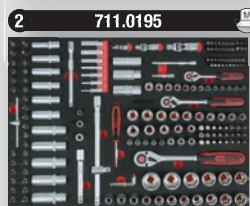
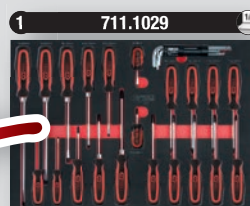

KRAFTPAKET - 598 DELAR

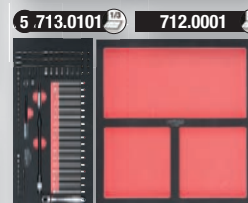
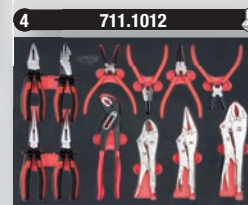

Mer information

RACING *line*

Med sju lådor och
598-delars premiumverktyg

20080,-

826.7598



från
350,-



A	517.0048			8 · 9 · 10 · 11 · 13 · 14 17 · 19 mm	350,- SEK
B	517.0052			8 · 9 · 10 · 11 · 12 · 13 · 14 15 · 16 · 17 · 18 · 19 mm	640,- SEK
C	517.0043			6 · 7 · 8 · 9 · 10 · 11 · 12 13 · 14 · 15 · 16 · 17 · 18 19 · 20 · 21 · 22 · 24 · 27 30 · 32 mm	1640,- SEK

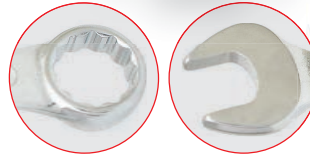

från
280,-



A	517.0148			6x7 · 8x9 · 10x11 · 12x13 14x15 · 16x17 · 18x19 20x22 mm	280,- SEK
B	517.0123			6x7 · 8x9 · 10x11 · 12x13 14x15 · 16x17 · 18x19 20x22 · 21x23 · 24x27 30x32 mm	670,- SEK
C	517.0125			6x7 · 8x9 · 10x11 · 12x13 14x15 · 16x17 · 18x19 20x22 · 21x23 · 24x27 25x28 · 30x32 mm	760,- SEK



från
360,-

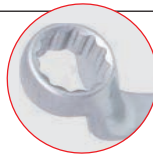

A	517.0248			6x7 · 8x9 · 10x11 · 12x13 14x15 · 16x17 · 18x19 20x22 mm	360,- SEK
B	517.0222			6x7 · 8x9 · 10x11 · 12x13 14x15 · 16x17 · 18x19 20x22 · 21x23 · 24x27 30x32 mm	760,- SEK



i Mer information

från 610,-

517.0670	230 mm	610,- SEK
517.0675	340 mm 1/2"	720,- SEK
517.0680	450 mm 1/2"	1520,- SEK
517.0685	580 mm 3/4"	2300,- SEK

i Mer information

VÄNDBAR 4-I-1-SPÄRRHÅKE

TOP SELLER

10 mm
13 mm
17 mm
19 mm

280,-

503.4565 10 x 13 x 17 x 19 mm

72 **5°**

i **1**
Mer information

TOP SELLER

8 - 17 mm

260 mm

8-17 mm

114.0055

510,-

14 - 32 mm

www.kstools.com

114.0055

1
2
3

8 · 9 · 10 · 11 · 12 · 13 · 14 · 15 · 16 · 17 · 18 · 19 · 20 · 21
22 · 23 · 24 · 25 · 26 · 27 · 28 · 29 · 30 · 31 · 32 mm

i **3**
Mer information

NEW

ELLER

fäste med möjlighet till förlängning eller invändig fyrkant

760,-

14 - 32 mm

5 - 11 mm

8 - 17 mm

14 - 32 mm

1/4"

3/8"

1/2"

www.kstools.com

114.0060

114.0060

5 · 6 · 7 · 8 · 9 · 10 · 11 · 12 · 13 · 14 · 15 · 16 · 17 · 18 · 19
20 · 21 · 22 · 23 · 24 · 25 · 26 · 27 · 28 · 29 · 30 · 31 · 32 mm

i **10**
Mer information

SMAL VERSION

3/8" 1/2" 3/4"

2050,-

913.1300

19 - 21 - 22 - 24 - 27 - 30 - 32 - 36 - 41 - 46 mm

i **10**
Mer information

72 \times 5°

2000,-

503.4250

8 - 10 - 11 - 12 - 13 - 14
16 - 17 - 18 - 19 mm

i **12**
Mer information

72 \times 5°

1790,-

503.4665

8 - 9 - 10 - 11 - 12 - 13 - 14
15 - 16 - 17 - 18 - 19 mm

L R

i **16**
Mer information

2280,-

1/2"
3/8"
1/4"

1/4" x 10 mm

1/4" x 10 mm
3/8" x 13 mm
1/2" x 19 mm

12 x

503.4266 8-9-10-11-12-13-14-15-16-17-18-19 mm

i **30**
Mer information

2520,- **TOP SELLER**

5/16" x 13 mm
10 mm x 13 mm
1/4" x 10 mm

1/2"
3/8"
1/4"

12 x

503.4960 8-9-10-11-12-13-14-15-16-17-18-19 mm

i **1**
Mer information

ARBETA GRÄNSLÖST!

1/4"

75 mm

280,-

912.1485

DRA UT, DRA UT! **TOP SELLER**

520,-

72 \times 5°

Mer information **2**

914.1412

1/2" 305 - 445 mm

1/4" 173 - 223 mm

justerbar:
1/4" i 4 steg
1/2" i 6 steg

i **1**
Mer information

914.1205

Steg: 1 2 3 4 5 6

360,-

1/2" 600 MM!

460 - 600 mm

Justerbar i 6 steg

i **1**
Mer information

från 270,-

A	918.1291	1/2"	378 mm	270,- SEK
B	918.1297	1/2"	460 mm	520,- SEK
B	918.1292	1/2"	655 mm	550,- SEK
B	918.1293	1/2"	750 mm	760,- SEK

1/2"

	Nm		↔		
914.1420		1/4"	60	150 - 200 mm	450,- SEK
914.3820		3/8"	248	258 - 373 mm	560,- SEK
914.1220		1/2"	610	294 - 432 mm	640,- SEK



	Nm		↔		
920.1490		1/4"	102	140 mm	360,- SEK
920.3890		3/8"	325	190 mm	450,- SEK
920.1290		1/2"	710	245 mm	550,- SEK



från 450,-

	Nm		↔		
935.1490		1/4"	110	125 mm	450,- SEK
935.3890		3/8"	365	199 mm	600,- SEK
935.1290		1/2"	950	275 mm	760,- SEK
935.1295		1/2"	950	425 mm	1040,- SEK

GARANTERAT: 6 MONSTER FÖR LIVET!

450,-

>100 Nm

935.1495

1/4" 106 g 125 mm

1500,-

TELESKOPSTÅNG

935.1285

406 431 457 482 508 533 557 582 607 635 mm

>950 Nm

1/2" 1.280 g 406 - 635 mm

1/4" x 3/8" - 3/8" x 1/4"
3/8" x 1/2" - 1/2" x 3/8"
1/2" x 3/4" - 3/4" x 1/2"

210,-

A B

1/4" + 3/8" + 1/2" + 3/4"

A	917.0707		Matt satinerat	7	210,- SEK
B	918.0707		Kromad och blankpolerad	7	210,- SEK

4 - 5 - 6 - 7 - 8 - 9 - 10 - 12 - 14 mm

A

från **520,-**

T10 - T15 - T20 - T25 - T27 - T30 - T40 - T45 - T50 - T55

B

3/8"

28 mm 50 mm

A	917.4000			9	520,- SEK
B	917.4015			10	600,- SEK

EXTRA KORT MODELL

Mer information

50

- 2 - 2,5 - 3 - 4 - 5 - 6
7 - 8 - 9 - 10 mm
- M5 - M6 - M7 - M8 - M9
M10 - M12
- T10 - T15 - T20 - T25 - T27
T30 - T40 - T45 - T47 - T50
- PH1 - PH2 - PH3
- 6 - 10 mm
- 7/32" - 1/4"
5/16" - 3/8"
- IPR20 - IPR25
IPR27 - IPR30
IPR40 - IPR45
- IP10 - IP15 - IP20 - IP25
IP30 - IP40 - IP45 - IP50

1/4"

510,-

28 mm 37 mm

911.1850

Mer information

19

710,-

1/4" + 3/8" + 1/2"

- EPL4 - EPL5 - EPL6 - EPL7 - EPL8 - EPL10 - EPL11 - EPL12 - EPL14
EPL16 - EPL18 - EPL20 - EPL22 - EPL24 - EPL26 - EPL28 - EPL30 - EPL32
- EPL8,8

515.0119

NY UTÖKAD SATS, NU MED 101 DELAR!

Mer information

101

5 x		1/4": E4 - E5 - E6 - E7 - E8	8 x		1/4": T6 - T8 - T10 - T15 - T20 T25 - T27 - T30
5 x		3/8": E10 - E11 - E12 - E14 - E16	5 x		3/8": T40 - T45 - T47 - T50 - T55
4 x		1/2": E18 - E20 - E22 - E24	2 x		1/2": T60 - T70
5 x		1/4": EPL4 - EPL5 - EPL6 - EPL7 EPL8	7 x		1/4": TB8 - TB10 - TB15 - TB20 TB25 - TB27 - TB30
5 x		3/8": EPL10 - EPL11 - EPL12 EPL14 - EPL16	4 x		3/8": TB40 - TB45 - T50 - T55
8 x		1/2": EPL18 - EPL20 - EPL22 - EPL24 EPL26 - EPL28 - EPL30 - EPL32	1 x		1/2": TB60
5 x		1/4": EPR4 - EPR5 - EPR6 - EPR7 EPR8	7 x		1/4": IP8 - IP10 - IP15 - IP20 IP25 - IP27 - IP30
5 x		3/8": EPR10 - EPR11 - EPR12 EPR14 - EPR16	3 x		3/8": IP40 - IP45 - IP50
8 x		1/2": EPR18 - EPR20 - EPR22 - EPR24 EPR26 - EPR28 - EPR30 - EPR32	2 x		1/2": IP55 - IP60
			7 x		1/4": IPR8 - IPR10 - IPR15 IPR20 - IPR25 - IPR27 - IPR30
			3 x		3/8": IPR40 - IPR45 - IPR50
			2 x		1/2": IPR55 - IPR60

1790,-

1/4" + 3/8" + 1/2"

911.7101

1200,-



1/2"

A HEX **B** RIBE **C** XZN **D** TORX

A	911.4510				5 - 6 - 7 - 8 - 10 - 12 14 - 17 - 19 mm	1200,- SEK
B	911.4520				M5 - M6 - M7 - M8 M9 - M10 - M12 M13 - M14	1200,- SEK
C	911.4540				M5 - M6 - M8 - M9 M10 - M12 - M14 - M16	1200,- SEK
D	911.4550				T20 - T25 - T27 - T30 T40 - T45 - T50 - T55 T60 - T70	1200,- SEK

Mer information



1/2"

10 - 11 - 12 - 13 - 14 - 15
16 - 17 - 18 - 19 - 22 - 24
27 - 30 - 32 mm



900,-

911.0620

SATSER ATT ÄLSKA

från
410,-



A

B

1/4"



4 - 4,5 - 5 - 5,5 - 6 - 7 - 8 - 9
10 - 11 - 12 - 13 - 14 mm

Mer information



1/4"

4 - 4,5 - 5 - 5,5
6 - 7 - 8 - 9 - 10
11 - 12 - 13 - 14 mm



470,-

911.0653

från 1200,-

1/4" + 1/2"

○ — ⊕ ⊗ ⊖ ⊛ ⊙
 ○ 4 - 4,5 - 5 - 5,5 - 6 - 7 - 8 - 9
 10 - 11 - 12 - 13 - 14 - 15 - 16
 17 - 18 - 19 - 20 - 21 - 22 - 23
 24 - 27 - 30 - 32 mm

A	911.0694		Matt satinerat	94	1200,- SEK
B	918.0694		Kromad och blankpolerad	94	1340,- SEK

Mer information

108

1340,-

1/4" + 1/2"

○ — ⊕ ⊗ ⊖ ⊛ ⊙
 ○ 4 - 4,5 - 5 - 5,5 - 6 - 7 - 8 - 9
 10 - 11 - 12 - 13 - 14 - 15 - 16
 17 - 18 - 19 - 20 - 21 - 22 - 24
 27 - 30 - 32 mm

911.0708

Mer information

82

KOMPLETTERANDE UPPSÄTTNING SEXKANTS- OCH TUMDIMENSIONER

○ 5/32" - 3/16" - 7/32" - 1/4"
 9/32" 5/16" 11/32" - 3/8"
 7/16" - 1/2" 9/16" - 5/8"
 11/16" - 3/4" - 13/16" - 7/8"
 9/16" - 5/8" - 11/16" - 3/4"
 13/16" - 7/8" - 15/16" - 1"
 1.1/16" - 1.1/8" - 1.3/16"
 1.1/4"

○ 5/32" - 3/16" - 7/32" - 1/4"
 9/32" 5/16" - 11/32" - 3/8"
 7/16" - 1/2" - 9/16" - 5/8"
 11/16" - 3/4" - 13/16" - 7/8"
 9/16" - 5/8" - 11/16" - 3/4"
 13/16" - 7/8" - 15/16" - 1"
 1.1/16" - 1.1/8" - 1.3/16"
 1.1/4"

1300,-

1/4" + 3/8" + 1/2"

917.0082

Mer information

133

1300,-

1/4" + 3/8" + 1/2"

○ — ⊕ ⊗ ⊖ ⊛ ⊙
 ○ 4 - 4,5 - 5 - 5,5 - 6 - 7 - 8 - 9
 10 - 11 - 12 - 13 - 14 - 15 - 16
 17 - 18 - 19 - 20 - 21 - 22 - 23
 24 - 27 - 30 - 32 - 34 - 36 mm

⊛ E4 - E5 - E6 - E7 - E8 - E10
 E11 - E12 - E14 - E16 - E18
 E20 - E22 - E24

917.0133

från
1640,-

1/4" + 3/8" + 1/2"

A	917.0795		Matt satinerat	195	1640,- SEK
B	918.0795		Kromad och blankpolerad	195	1770,- SEK

från
2610,-

1/4" + 3/8" + 1/2"

A	917.0216		Matt satinerat	216	2610,- SEK
B	918.0216		Kromad och blankpolerad	216	2830,- SEK

TOP SELLER

1/4" + 3/8" + 1/2"

från
1790,-

A	917.0255		225		6-kant + mm	1790,- SEK
B	916.0255		225		12-kant + tum	1790,- SEK

3/4"

från
3280,-

A	911.0721		21		6-kant + mm 19-50 mm	3280,- SEK
B	911.0722		21		12-kant + mm 19-50 mm	3710,- SEK
C	911.0751		21		12-kant + tum 3/4" - 2"	3710,- SEK

i  **47**
Mer information



1800,-

1/2"







917.0047 



från 2610,-

1/4" + 1/2"

A	917.0797 	Matt satinerat	97	2610,- SEK
B	918.0797 	Kromad och blankpolerad	97	2830,- SEK



i  **62**
Mer information



1300,-

1/4"









917.0062

i  **88**
Mer information



2830,-

1/4" + 1/2"















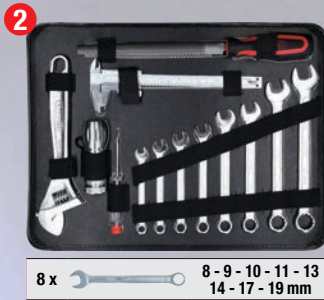





911.0688

TOP SELLER



i  127
Mer information



	4 - 4,5 - 5 - 5,5 - 6 - 7
	8 - 9 - 10 - 11 - 12
	13 - 14 mm
	   
	  
	10 - 13 - 14 - 16 - 17
	18 - 19 - 20 - 22 - 24
	27 - 30 - 32 mm

5510,-

911.0727









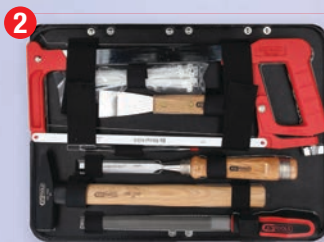
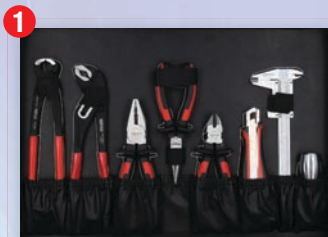



1/4" + 1/2"



ALLROUNDERN

i  149
Mer information

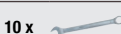

	4 - 4,5 - 5 - 5,5 - 6 - 7
	8 - 9 - 10 - 11 - 12
	13 mm
	   
	  
	10 - 13 - 14 - 15 - 16
	17 - 18 - 19 - 21 - 22
	24 - 27 - 30 - 32 mm
	8 - 10 - 11 - 12 - 13
	14 - 15 - 17 - 19 - 22 mm

911.0649

1/4" + 1/2"



5810,-



Mer information



9 x 1,5 - 2 - 2,5 - 3 - 4 - 5 - 6
8 - 10 mm

9 x TS10 - TS15 - TS20 - TS25
TS27 - TS30 - TS40 - TS45
TS50



1/4" 4 - 4,5 - 5 - 5,5 - 6 - 7
8 - 9 - 10 - 11 - 12
13 mm

1/2" 10 - 11 - 12 - 13 - 14
15 - 16 - 17 - 18 - 19
21 - 22 - 24 - 27 - 30
32 mm

11 x 8 - 9 - 10 - 11 - 12
13 - 14 - 16 - 17 - 19
22 mm

911.0630

1/4" + 1/2"



6700,-

SPÄNNANDE OCH MED POWER!



Mer information



1/4" 4 - 4,5 - 5 - 5,5 - 6 - 7 - 8
9 - 10 - 11 - 12 - 13 mm

1/2" 10 - 11 - 12 - 13 - 14 - 15
16 - 17 - 18 - 19 - 21 - 22 mm

10 x 8 - 10 - 11 - 12 - 13 - 14
15 - 17 - 19 - 22 mm

911.0628

1/4" + 1/2"





5810,-

i  127 
Mer information

BLI MOBIL!

1/4" + 1/2"



1/4"		4 - 5 - 6 - 7 - 8 - 9 - 11 12 - 13 mm
1/2"		10 - 11 - 12 - 13 - 14 - 15 - 16 17 - 18 - 19 - 21 - 22 - 24 mm
11 x		8 - 9 - 10 - 11 - 12 - 13 14 - 16 - 17 - 18 - 19 mm







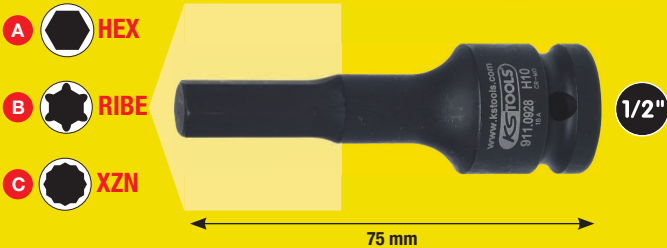

7750,-

911.0735

NEW

610,-



A	911.0902				5 - 6 - 8 - 10 - 12 14 - 17 - 19 mm	610,- SEK
B	911.0934				M5 - M6 - M7 - M8 M9 - M10 - M12 M13 - M14	610,- SEK
C	911.0944				M4 - M5 - M6 - M8 - M9 M10 - M12 - M14 - M16	610,- SEK

i  40 
Mer information



**TOP
SELLER**

1720,-



KALIBRERAD FÖR FRAMTIDEN!



Mer information

EN FÖR ALLTID!



Infinitool



Leverans i plastväska



SERVICE REMINDER

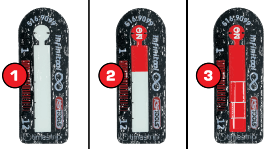

START 1 6 12 MONTH



KALIBRERING EFTER TOLV MÅNADER

Första gången du använder den utlöser du servicepåminnelsen. Efter tolv månader får du automatiskt en synlig röd skala som indikerar att din momentnyckel behöver kalibreras.

		Nm	Delning Nm	Lbf-ft		
516.9002		1/4"	1-5	0,02	0,7 - 3,7	850,- SEK
516.9012		1/4"	5-25	0,10	3,7 - 18	940,- SEK
516.9022		3/8"	10-50	0,10	7 - 37	1000,- SEK
516.9032		1/2"	20-100	0,10	8 - 67	1080,- SEK
516.9042		1/2"	20-200	1,00	20 - 150	1140,- SEK
516.9072		1/2"	60-320	1,00	45 - 235	1370,- SEK
516.9082		1/2"	80-420	1,00	65 - 315	1520,- SEK
516.9090		3/4"	110-550	2,00	75 - 415	7110,- SEK
516.9093		3/4"	150-750	5,00	100 - 550	8250,- SEK
516.9095		1"	200-1000	5,00	150 - 750	10690,- SEK



från

850,-

Skala med lupp

Mikrometerskala



Mer information

SERVICE REMINDER

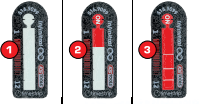

Infinitool

2520,-



1X LIVSTID, TACK!



1/2"

516.9110 14 x 18 mm 17 - 22 - 24 - 26 - 27 - 29 mm



Mer information

SERVICE REMINDER

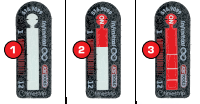

Infinitool

2370,-



KORREKT FÖR ALLTID!



1/2"

516.9105 14 x 18 mm 13 - 15 - 16 - 17 - 18 - 19 - 21 mm



A	151.4420			9		1,5 - 2 - 2,5 - 3 - 4 5 - 6 - 8 - 10 mm	280,- SEK
B	151.5210			9		T10 - T15 - T20 T25 - T27 - T30 T40 - T45 - T50	360,- SEK

i **208**

Mer information

600,-

1/4"		1/4": 205 mm
138 x		25 mm
29 x		50 mm
18 x		75 mm
20 x		4 - 5 - 6 - 7 - 8 - 9 - 10 - 11 - 12 - 13 mm 5/32" - 3/16" - 7/32" - 1/4" - 9/32" 5/16" - 11/32" - 3/8" - 7/16" - 1/2"
1 x		1/4": 50 mm
1 x		1/4"

911.2008

i **32**

Mer information

1410,-

1 x		8 x 10 mm
1 x		4 mm
3 x		PH0 - PH1 - PH2
5 x		4 - 5 - 6 - 7 - 8 mm
4 x		5 - 6 - 8 - 10 mm
9 x		T8 - T10 - T15 - T20 - T25 - T27 T30 - T40 - T45
9 x		T88 - TB10 - TB15 - TB20 - TB25 TB27 - TB30 - TB40 - TB45

503.4670

i **31**

Mer information

870,-

10 x		5 - 6 - 7 - 8 - 9 - 10 11 - 12 - 13 - 14 mm
1 x		1/4" x 11 mm
2 x		4 - 6 mm
4 x		PH0 - PH1 - 2 x PH2
3 x		PZ0 - PZ1 - PZ2
4 x		3 - 4 - 5 - 6 mm
7 x		T10 - T15 - T20 - T25 T27 - T30 - T40

918.3050

i **108**

Mer information

450,-

TORION power

1/4"

6x: 4 - 5 - 6 mm	6x: PZ1 - PZ2 - PZ3
6x: PH1 - PH2 - PH3	6x: 4 - 5 - 6 mm
6x: T10 - T15 - T20 - T25 - T30 - T40	

918.3108

i **32**

Mer information

160,-

TORION power

1/4"

4 x		3 - 4 - 5 - 6 mm
4 x		PH1 - 2 x PH2 - PH3
4 x		PZ1 - 2 x PZ2 - PZ3
4 x		3 - 4 - 5 - 6 mm
7 x		T10 - T15 - T20 - T25 T27 - T30 - T40
7 x		TB10 - TB15 - TB20 - TB25 TB27 - TB30 - TB40

911.3030

i **32**

Mer information

670,-

TORION power

1/4"

4 x		3 - 4 - 5 - 6 mm
4 x		PH1 - 2 x PH2 - PH3
4 x		PZ1 - 2 x PZ2 - PZ3
4 x		3 - 4 - 5 - 6 mm
7 x		T10 - T15 - T20 - T25 T27 - T30 - T40
7 x		TB10 - TB15 - TB20 - TB25 TB27 - TB30 - TB40

918.3010

i **1**
Mer information

1/4"

80 mm

70,-

159.1171

i **1**
Mer information

1/4"

95 mm

110,-

159.1172

1/4" **från 160,-**

A	159.2025		6 i 1 Mini-spärrskruvmejsel	160,- SEK
B	159.2035		12-i-1 spärr-bits-skruvdragare	210,- SEK

TOP SELLER

6 IN ONE

110 mm **A**

- 4 - 5 mm
- PH1 - PH2
- PZ1 - PZ2

12 IN ONE

240 mm **B**

- 4 - 5 - 6 mm
- PH1 - PH2 - PH3
- 3 - 4 - 5 mm
- T15 - T20 - T25

i **1**
Mer information

1/4" **140,-**

60 mm

159.1176 **T-handtag dubbel bitshållare**

i **1**
Mer information

1/4" **70,-**

210 mm

159.1174 **Bitshållarförlängning**

i **1**
Mer information

200 - 400 mm

1/4" **210,-**

159.1175 **Teleskopbitshållare med T-handtag**

Tums T-fyrkantshandtag

från 70,-

A 140 mm

B 300 mm

A	151.1111		1/4" kort	70,- SEK
B	151.1112		1/4" lång	110,- SEK

Kromad med polerad spets

med profilmärkning i handtaget

från 160,-

A	159.0005			5		4 - 5,5 - 6,5 mm PH1 - PH2	160,- SEK
B	159.0030			6		T10 - T15 - T20 T25 - T30 - T40	210,- SEK
B	159.0040			6		TB10 - TB15 - TB20 TB25 - TB30 - TB40	210,- SEK

39

770,-

TOP SELLER

Mer information

6 x			3 - 4 - 5,5 - 6,5 8 - 10 mm
5 x			PH0 - PH1 PH2 - PH3 PH4
4 x			PZ0 - PZ1 PZ2 - PZ3
1 x			6 mm
1 x			PH2
7 x			2 - 2,5 - 3 - 4 5 - 6 - 8 mm
7 x			TB10 - TB15 TB20 - TB25 TB27 - TB30 TB40
7 x			T10 - T15 - T20 T25 - T27 - T30 T40
1 x			1/4"
1 x			205 mm

159.0100 **1/4"**

13

1010,-

TOP SELLER

Mer information

5 x			3,5 - 5,5 - 7 - 8 - 10 mm
5 x			PH0 - PH1 - PH2 - PH3 - PH4
1 x			6 mm
1 x			PH2
1 x			1/4"

151.1150 **1/4"**

3

EXTRA LÅNG

280,-

Mer information

450 mm

6 mm **PH2** **T15**

159.1270

11

410,-

1/2"

Mer information

1 x			1/2"
1 x			1/2" x 5/16"
6 x			5 - 6 - 8 - 10 - 12 - 14 mm
3 x			PH1 - PH2 - PH3

515.1003 **Hand-mutterdragare-sats**

i **15**
Mer information

260 mm

A

1010,-

i **17**
Mer information

B

2610,-

510 mm

3 x

8,5 x 5,5 - 17 x 12 - 19 x 15 mm

5 x

M4 - M5 - M6 - M8 - M10

6 mm

i **1**
Mer information

280 mm

C

540,-

360°

STABILA NITAR. SOM SITTER.



Nitar (aluminium)

Nitar (stål)



Mutter

		A	B	C
		150.9805	150.9630	150.9540
	i resväskan	✓	✓	✗
	längd mm	260	510	280
	plåtperforator	✓	✗	✗
	en- eller tvåhands-operation			
	M10	✓	✓	✗
	M8	✓	✓	✗
	M6	✓	✓	✗
	M5	✓	✓	✗
	M4	✓	✓	✗
	M3	✓	✓	✗
	Stål 4,8 mm	✓	✓	✓
	Stål 4,0 mm	✓	✓	✓
	Stål 3,2 mm	✓	✓	✓
	Stål 2,4 mm	✓	✓	✓
	Aluminium 6,4 mm	✓	✓	✗
	Aluminium 4,8 mm	✓	✓	✓
	Aluminium 4,0 mm	✓	✓	✓
	Aluminium 3,2 mm	✓	✓	✓
	Aluminium 2,4 mm	✓	✓	✓

i   **1**
Mer information



från
130,-

115.2015	128 mm	5"	15	130,- SEK	NEW
115.2017	178 mm	7"	18	140,- SEK	
115.2018	250 mm	10"	25	210,- SEK	
115.2019	305 mm	12"	30	250,- SEK	
115.2021	407 mm	16"	28	380,- SEK	



> 50 mm

128 mm / 5"

MINI



NEW

CrV **DIN 5254 A** **DIN 5254 B**
DIN 5256 C **DIN 5256 D**

A 19 - 60 mm
B 40 - 100 mm

0° 90° 0° 90°

från 1370,-

A	119.2055		19 - 60 mm 160 mm	1370,- SEK
B	119.2060		40 - 100 mm 230 mm	1430,- SEK

i   **5**
Mer information

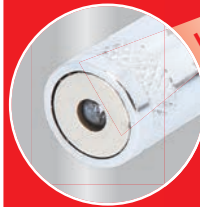

5i1

**TOP
SELLER**

inklusive snabbblåsning



210,-

172 - 640 mm

550.1145

i   **1**
Mer information

Polygrip

- ersätter kompletta nyckelsatser för metriska skruvar och tum-skruvar
- hög utväxling möjliggör hög press- och klämkraft vid backarna

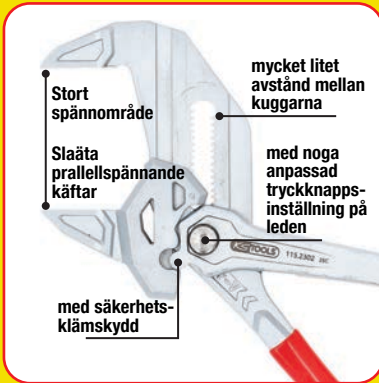

från
250,-

TILLVAL

3 par



130,-



utbytbara skyddsbackar som tillval

115.2301	180 mm	2,5 mm	14	0 - 37 mm	250,- SEK
115.2302	260 mm	2 mm	19	0 - 50 mm	320,- SEK
115.2303	300 mm	2 mm	22	0 - 64 mm	410,- SEK

115.2311	180 mm		3 x 2	130,- SEK
115.2312	260 mm		3 x 2	130,- SEK
115.2313	300 mm		3 x 2	130,- SEK

i  **4**
Mer information

160,-



550.1045 45° 135° 0° 90°



i  **9**
Mer information

280,-

**TOP
SELLER**



45° 135° 0° 90° 45° 90° 0°

i  **11**
Mer information

Ø 40 mm

20 mm 33 mm 1,6 mm 3,5 mm 4,5 mm 5 mm

30 mm 95 mm 95 mm

200 mm

**ISO
BUTAN**

Piezo

450,-

960.1160 Mikrolödnings-sats



i  **5**
Mer information

temperaturreglering:
1≈50°C / 2≈100°C / 3≈200°C /
4≈350°C / 5≈550°C / 6≈650°C

260 mm

1 2 3 4 5 6

1 max. 450°C
2 max. 650°C

450,-

960.1190



i  **283**
Mer information

Ø 0,5 - 6 mm Ø 0,5 - 6 mm Ø 0,5 - 10 mm

Ø 6,50 / 5,41 / 1,72 mm Ø 0,5 - 4 mm

Ø 1,0 - 3,2 mm

220 mm

2530,-

115.1400

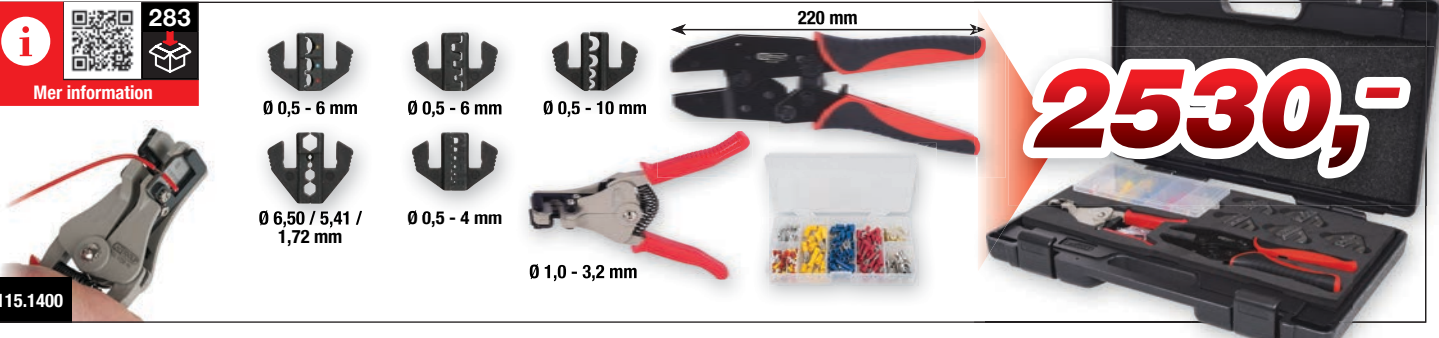

i  **1**
Mer information

IP 34

15 + 1 m

3x 1,5 mm²

230 V 50 Hz

1000/3000 W

10 A

• Belastningsbar i hoprullat läge: 1000 W
• Belastningsbar i hoprullat läge: 3000 W

15 m

1,0 m

2010,-

180°

STOP

150.4217 Verkstad kabel-vinda



1 Mer information

138 x 69 x 31 mm 342 9 V Data Hold

280,-

69 mm 138 mm

1 Mer information

MULTITALENTET BARA ATT RINGA ÄR INTE MÖJLIGT ÄN.

143 x 70 x 16 mm 119 AAA Data Hold

760,-

143 mm 70 mm 16 mm

TOP SELLER

NCV

USB-A USB-C

AUTOMATIC DIGITAL MULTIMETER

Symbol	Beskrivning
DC	DC spänning
AC	AC spänning
⏻	Indikator för automatisk avstängning
🔋	Indikator för lågt batteri
▶	Diodläge
)))	Textavsnitt
	Kapacitet
%	Effektmätarförhållande
HOLD	Datahållningsfunktion
V, mV	Spänningenshet: volt, millivolt
mF, μF, nF	Kapacitetsenhet
MΩ, KΩ, Ω	Motståndsenhet
NCV	Beröringsfri spänningsinduktion
Live	Testar levande linjer
KHz, Hz	Frekvensenhet
°C/°F	Celsius/Fahrenheit

Nej. Beskrivning

- 1 Strömknappen
- 2 Funktionsomkopplare
- 3 Kapacitansbrytare
- 4 Belysningsbrytare
- 5 LCD skärm
- 6 NCV-sensorområde
- 7 Testledning

1 Mer information

190 x 90 x 35 mm 210 g 9 V Data Hold

1450,-

90 mm 190 mm

V~ ▶ 6 V - 750 V
 A~ ▶ 600 μA - 10 A
 V... ▶ 600 mV - 1000 V
 A... ▶ 600 μA - 10 A
 Ω ▶ 600 Ω - 60 MΩ
 F ▶ 300 mA/600 V
 10 A/600 V
 (32x6 mm)

i **1**
Mer information

350,-

300.0510

i **1**
Mer information

360,-

+/- 0,03 mm

+

300.0532

i **1**
Mer information

HET FÖR PRECISION:
INFRARÖD TERMOMETER -38° TIL 520°C

760,-

150.3040

i **4**
Mer information

850,-

550.1290

Refraktometer - optisk testutrustning för batteridensitet och frostskyddsmedel

i **4**
Mer information

1010,-

ÄVEN FÖR ADBLUE®!

550.1285

Refraktometer - optisk testutrustning för batteridensitet, frostskyddsmedel och AdBlue®-tillsats

i **4**
Mer information

280,-

11 mm
200 mm
16 mm
300 mm
20 mm
450 mm
20 mm
600 mm

911.8100 Bräckjärn-sats

i **4**
Mer information

XL

2140,-

900 mm
600 mm
0°
45°
75°
90°

911.8410

i  **12**
Mer information



4460,-



700.1300

i  **22**
Mer information



10t.

Hydraulisk universal-avdragare-sats 2+3-armad

- låg glidfara genom automatisk förslutande avdragararmar
- 8 avdragarevarianter möjliga
- Extremt robust spindel med induktivt härdad gänga
- Låg kraftinsats
- Speciellt-verktygsstål

4550,-

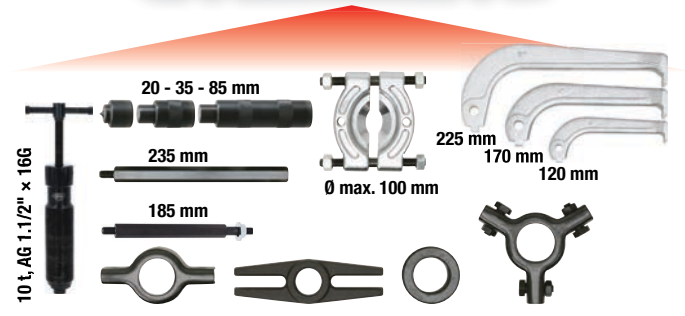

700.1200

VÅRA NÖDFALLSSATSER

i  **13**
Mer information

Rescue power

TOP SELLER

1200,-

Inklusive
3/8" 1/2" 3/8"

8 - 9 - 10 - 11 - 12 - 13 - 14 - 15 - 16 - 17 - 18 - 19 mm

913.3930

0 % ✓ 85 % ✓
för att lossa och skruva loss
muttrar och bultar med skadade
huvuden eller

upp till 85 %
"rundade" huvuden

i  **7**
Mer information

Rescue power

TOP SELLER

1340,-

Ringar böjda 45°

6x7 - 8x9 - 10x11 - 12x13 - 14x15 - 16x17 - 18x19 mm

517.1555



Mer information

240,-

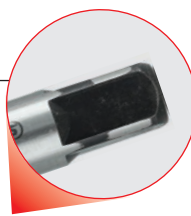

- För skruvar mellan M3 - M24
- Ger möjlighet för utskruvning av avrivna skruvar och bultar
- Koniskt utformad spiral
- i stabil plastlåda

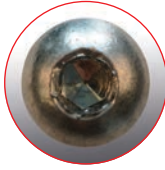
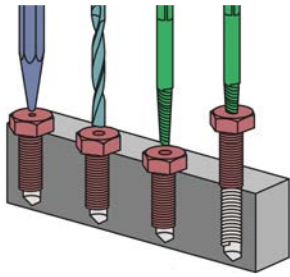

150.1330 Skruvavdragare-sats



Mer information

**TOP
SELLER**

TORXION^{power}

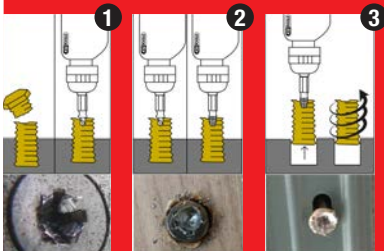

670,-

- 9 x TE10 - TE15 - TE20 - TE25 - TE27 - TE30 - TE40 - TE50 - TE55
- 9 x 1,5 - 2 - 2,5 - 3 - 4 - 5 - 6 - 8 - 10 mm
- 7 x 1,5 - 2 - 2,5 - 3 - 4 - 5 - 6 mm
- 7 x T10 - T15 - T20 - T25 - T27 - T30 - T40



150.7060 1/4" + 10 mm Torx-och insexkant-skrivar-utdragarsats



Mer information

600,-

- omfattande satssammansättning
- för borttagning av avbrutna gängbultar och skruvar
- inga skador på gängor
- endast obetydlig utvidgning av gängbult genom speciellt profilerat utdragningsstift

Führungshülse drill guide	Hülse Innen- Ø mm guide	vorborenen Ø mm pre-drilling	aufbohren re-drilling	Stift pin	Art.Nr. Stift No. Pin	Mutter D nut D	Art.Nr. Mutter nut D	Stift + Mutter pin + nut
150.0501	4,0 / 3,2	3,2	-	3,2	150.0521	SW 10	150.0511	150.0511S
150.0502	4,8 / 3,2	3,2	-	3,2	150.0521	SW 10	150.0511	150.0511S
150.0503	4,8 / 3,2	3,2	4,8	4,8	150.0522	SW 11	150.0512	150.0512S
150.0504	4,8 / 3,2	3,2	4,8	4,8	150.0522	SW 11	150.0512	150.0512S
150.0505	6,0 / 4,8	4,8	6,4	6,4	150.0523	SW 13	150.0513	150.0513S
150.0506	7,0 / 4,8	4,8	6,4	6,4	150.0523	SW 13	150.0513	150.0513S
150.0507	7,0 / 4,8	4,8	8,0	8,0	150.0524	SW 14	150.0514	150.0514S
150.0508	7,0 / 4,8	4,8	8,7	8,7	150.0525	SW 17	150.0515	150.0515S
150.0509	9,0 / 6,5	6,4	8,7	8,7	150.0525	SW 17	150.0515	150.0515S
150.0510	9,5 / 6,5	6,4	8,7	8,7	150.0525	SW 17	150.0515	150.0515S

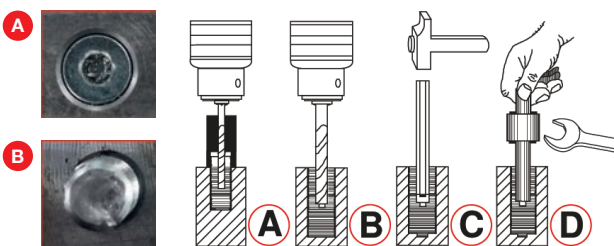

150.1305 M5 - M6 - M8 - M10 - M12 - M14 - M16 Skruvutdragning-sats

i  **7**
Mer information

760,-



1/2" 21 mm

M5 M6 M7 M8 M10 M12 M14

152.1101 M5 - M6 - M7 - M8 - M10 - M12 - M14 **Ståbult-urvidare-sats**

i  **12**
Mer information



360,-

Mikrofinstickad

	Storlek	Innehåll
310.0490	7	12 par
310.0491	8	12 par
310.0470	9	12 par
310.0475	10	12 par
310.0480	11	12 par

EN388
4131X

i  **100**
Mer information

PERFECT GRIP

SENSITIVE

Av nitril

HELT RIVTÅLIG, MED ANTI-SVETTEFFEKT

280,-

8 mil

S = 80±5 mm
M = 95±10 mm
L = 110±10 mm
XL = 120±10 mm

CE 2777
EN ISO 374-1:2016+A1:2018

i  **1**
Mer information

140,-



100 mm 160 mm 250 mm

4x U

160.0035 **Handskdispenser, magnetisk**

i  **1**
Mer information

Tekniska data:

Färgval: steglöst justerbar från DIN 9-13 standardljusinställning DIN 4

Omkopplings reaktionstid: 1/25.000 s

UV/IR skydd: 0,2 - 0,8 s Fördröjning (justerbar) enligt EN169 / bis DIN 16

Drifttemperatur: -5°C till +55°C

Lagertemperatur: -20°C till +70°C

Strömförsörjning: Litiumbatterier + solceller

Höjd: 220 mm

Bredd: 200 mm

Längd: 295 mm

Vikt: 480 g

Mått låda: 100 x 90 x 10 mm

Inspektionsfönster: 100 x 50 mm

760,-

310.0195

i **1**
Mer information

Universell tryckpump-atomiserare

- I högvärdig polyetylen
- för olika kemikalier som t.ex. tvätt-, lösnings- och rengöringsmedel osv.
- ej lämpat för bromsrengöring
- Justerbart och stängbart sprayhuvud i mässing
- Tätningar i Viton®
- Kan användas upp och ner

ej lämpat för bromsrengöring

150.8251	1 L	210,- SEK
150.8252	2 L	280,- SEK

från 210,-

i **1**
Mer information

UTSTRÅLAR PÅLITLIGHET! **NEW**

0,62 L

max. 6,3 bar (90 psi)

225 mm

105 mm

Ø 67 mm

960,-

aluminium

150.8273 Trycksprayflaska

enkelt byte mellan dim- och precisionsstråle

kan användas över huvudet

i **16**
Mer information

180,-

5x 12 mm

5x 16 mm

5x 20 mm

145 mm

907.2255 Skrapa-sats

i **27**
Mer information

280,-

5x 12 mm

5x 16 mm

5x 16 mm

5x 20 mm

145 mm

145 mm

19 mm

907.2200 Kniv-sats

A 190 mm

B 220 mm

från 160,-

Fällkniv med låsning

A	907.2105		1	190 x 25 mm	160,- SEK
B	907.2190		1	220 x 28 mm	180,- SEK

i **1**
Mer information

180,-

210 mm

907.2220 Fällkniv med låsning och bandskärare



540,-



eMONSTER
MED 3-VÄXLAD-MOMENTJUSTERING

6 Nm

NEW

max 6 Nm

max 4 Nm

max 2 Nm



TORION power

+30%

4 x		3 - 4 - 5 - 6 mm
3 x		PH1 - PH2 - PH3
3 x		PZ1 - PZ2 - PZ3
4 x		3 - 4 - 5 - 6 mm
5 x		T10 - T15 - T20 - T25 T27
5 x		TB10 - TB15 - TB20 - TB25 TB27

515.6550 eMONSTER Batteridrivna bit-rak skruvdragare-sats

- 3,6 V
- 1.500 mAh
- 300 rpm
- USB-C
- 4x LED



eMONSTER

2-i-1-enhet med en bra balans mellan prestanda och storlek, idealisk för arbete över huvudet och i trånga utrymmen.



praktisk batteriladdningsstatusvisning med 3 lysdioder

magnetisk bitshållare



1/4"

vridmomentförval justerbart i 10 steg

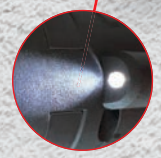

integrerad lampa

6 Nm

600,-

- 3,6 V
- 1300 mAh
- 210 rpm
- USB-C
- 2x 1x

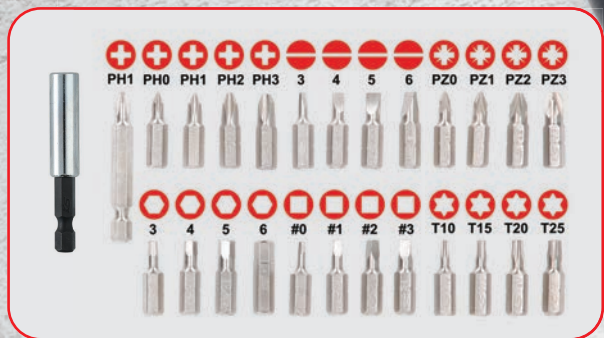

515.6550 eMONSTER Batteridrivna bit-rak skruvdragare-sats

i  **51**
Mer information

515.3990

MULTITALENTET

eMONSTER Sladdlös multiverktygssats med 50 tillbehör













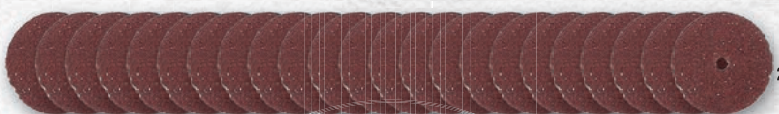

eMONSTER



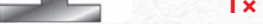

1 Borr
1x  Ø 3 mm

2 Rengöring
1x 

3 Slipning
1x  Ø 6 mm
4x  + 
23x  Ø 20 mm

4 Gravering
1x 
1x 
1x 
1x 
1x 
1x 
1x 
1x 
1x 
1x 

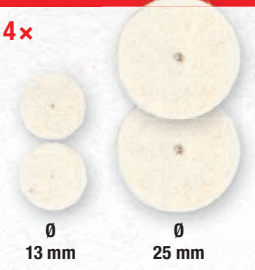
5 Separering
8x  Ø 24 mm
Ø 0,8 mm

6 Polering
4x  Ø 13 mm, Ø 25 mm
+  Putsnings
+ 

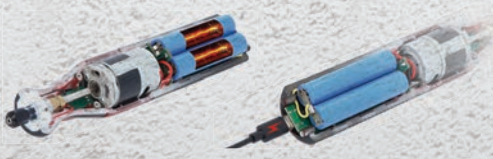

760,-

ATT KÖPA SENARE

i  **50**
Mer information



160,-

515.3992 Tillbehörssats, 50 delar

i  **32**
Mer information

**eMONSTER
TORSIONpower Bitslåda**

160,-

515.6932



1 x		1/4"
1 x		1/4"
4 x		3 - 4 - 5 - 6 mm
4 x		PH1 - 2 x PH2 - PH3
4 x		PZ1 - 2 x PZ2 - PZ3
4 x		3 - 4 - 5 - 6 mm
7 x		T10 - T15 - T20 - T25 - T27 - T30 - T40
7 x		TB10 - TB15 - TB20 - TB25 - TB27 - TB30 - TB40



i  **1**
Mer information



515.6901 eMONSTER verktygsskåp för väggmontering

i  **8**
Mer information

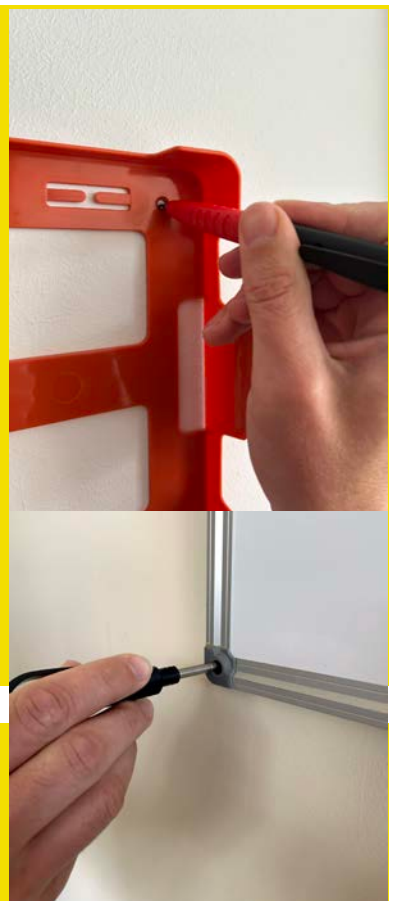

i  **60**
Mer information



TOP
SELLER

eMONSTER borstlös sladdlös borrh-/
skruvdragarset



eMONSTER borstlös sladdlös slagborrh-/
borrh-/skruvdragarset

TOP
SELLER

MINI



2390,-

Vridmoment max: 40 Nm
Adapter: 10 mm snabborrhchuck

515.6400

INKLUSIVE



Batterispänning: 18,0V
max. laddström: 3 A

Batterispänning: 18,0V
Batteriteknologi: Litium-Ijoner
Batterikapacitet: 2,0 Ah

leverans inkl två 2,0 Ah batterier och
3 A snabbaddare



INKLUSIVE



2830,-

Vridmoment max: 60 Nm
Adapter: 13 mm Röhm-metall-
snabbchuck

515.6300

TOP
SELLER

eMONSTER 1/2" borstlös
sladdlös slagnyckelsats



eMONSTER Borstlös
sladdlös vinkelslipsats

TOP
SELLER



vridmomentförval
justerbart i 3 steg

1/2 690 N•m
ÖFFNEN ∞

2/2 690 N•m
ÖFFNEN STOP

Vridstopp



15 mm 17 mm 19 mm 21 mm 22 mm

4020,-

Max. lös-vridmoment: 690 Nm
Adapter: 1/2"

515.6100

INKLUSIVE



Batterispänning: 18,0V
max. laddström: 8 A

Batterispänning: 18,0V
Batteriteknologi: Litium-Ijoner
Batterikapacitet: 4,0 Ah

leverans inkl två 4,0 Ah batterier och
8 A snabbaddare





Spännnyckel i
sidohandtaget

6 hastigheter



Varvtal: 9000 varv/min
Vibrationsacceleration: < 4,831 m/s²
3,371 m/s²

515.6200

i   **1**
Mer information **210,-**



A
B
C

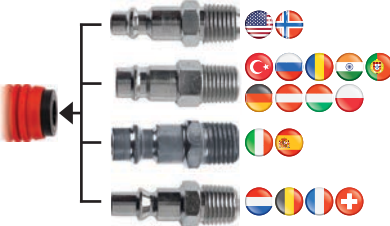

Universaltryckluftssäkerhetskoppling, 3-i-1

999.9101	A	9 mm	210,- SEK
999.9102	A	11 mm	210,- SEK
999.9103	A	14,5 mm	210,- SEK
999.9104	B	1/4" AG	210,- SEK
999.9105	C	1/4" IG	210,- SEK

i   **1**
Mer information



150 mm
1400 mm
1/4" PT
ON **OFF**

1850,-

515.3196 Tryckluft-graveringsstift

i   **1**
Mer information



1500 mm
1400 mm
110° vinklad
1/4" PT
3 mm
ON **OFF**
132 mm
1/4" PT
3 mm

KEVLAR
lång gångtid tack vare kevlar-lameller

från
1510,-

A	515.3179		110° vinklad	2750,- SEK
B	515.3197		Rakt utförande	1510,- SEK

i   **1**
Mer information



123 mm
6 mm
1/4" PT

1180,-

515.5530 SlimPOWER miniatur-tryckluft-stavslip, rak

i   **1**
Mer information



188 mm
6 mm
1/4" PT

1000,-

515.5410 Tryckluft-stavslip

i   **1**
Mer information



340 mm
1/4" PT

4880,-



2,4 mm 3,2 mm 4 mm 4,8 mm 5,6 mm 6,4 mm

515.3101 Tryckluft-blindnit-pistol

1.390 Nm

1/2"



1 515.1150



2980,-

1.390 Nm

1/2"



2 515.1270



2230,-

1.690 Nm

1/2"

3/4"

175 mm



3 515.1210

1/2"



2230,-

4 515.3785

3/4"



2830,-

1.084 Nm

1/2"



5 515.1315



1040,-

1.600 Nm

1/2"



6 515.1200



1040,-

2.000 Nm

3/4"



7 515.3400



1870,-

MED BI-TURBO PÅ HELA 2 300 NM
PÅ BARA ~ 15 SEKUNDER!

DEN ANDRA GENERATIONEN



genomtänkt frånluftskanal

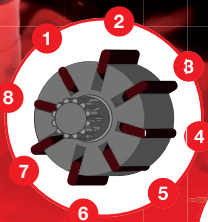
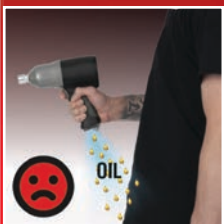

V8
8 istället för
6 rotorblad



185 mm

max. 2300 Nm	max. 851 Nm	max. 1256 Nm
1/4" NPT	244 L/min	6,3 bar (90 psi)
3/8"- 10 mm	<8,69 m/s ²	110,9 dbA
		99,7 dbA

8 512.0002



2090,-



3.405 Nm

3/4" 1"



9 515.3250

3/4"



12670,-

10 515.3270

1"



12670,-



3.405 Nm

3/4" 1"



11 515.3260

3/4"



13490,-

12 515.3280

1"



13490,-



4.250 Nm

3/4" 1"



13 512.3400

3/4"



6200,-

14 512.1015

1"



6890,-



4.050 Nm

3/4" 1"



15 512.3405

3/4"



6890,-

16 512.1020

1"



7580,-



			MAX. Nm	U/min	m/s ²	dbA	dbA	l/min	PT				kg
1	515.1150	1/2"	1390	10.000	<9,18	102,0	113,0	135	1/4"	-	✓	-	1,08
2	515.1270	1/2"	1390	10.00	<9,18	102,0	113,0	135	1/4"	-	✓	-	1,3
3	515.1210	1/2"	1690	7930	<17,9	87,0	98,0	178	1/4"	✓	-	-	2,1
4	515.3785	3/4"	1690	7930	<13,56	88,0	104,0	178	1/4"	✓	-	-	2,2
5	515.1315	1/2"	1084	9000	<10,36	160,0	115,0	169	1/4"	-	✓	-	1,2
6	515.1200	1/2"	1600	8500	<17,5	89,9	100,9	169	1/4"	✓	-	-	2,1
7	515.3400	3/4"	2000	8500	<17,25	91,0	100,9	169	1/4"	✓	-	-	2,2
8	512.0002	1/2"	2300	8500	<8,69	99,7	110,9	244	1/4"	✓	-	✓	1,6
9	515.3250	3/4"	3405	6200	<12,57	115,5	104,5	283	1/2"	✓	-	-	6,7
10	515.3270	1"	3405	6200	<12,57	115,5	104,5	283	1/2"	✓	-	-	6,7
11	515.3260	3/4"	3405	6200	<12,88	115,5	104,5	283	1/2"	✓	-	-	7,7
12	515.3280	1"	3405	6200	<12,88	115,5	104,5	283	1/2"	✓	-	-	7,8
13	512.3400	3/4"	4250	5500	<12,96	96,09	108,8	170	1/2"	✓	-	-	7,3
14	512.1015	1"	4250	5500	<12,96	96,09	108,8	170	1/2"	✓	-	-	7,3
15	512.3405	3/4"	4050	5500	<12,96	96,09	108,8	170	1/2"	✓	-	-	8,3
16	512.1020	1"	4050	5500	<12,96	96,09	108,8	170	1/2"	✓	-	-	8,3



Krafftfullt slagverk med dubbla hammare



Högprestanda Jumbo-mekanism



BITURBO-teknologi

ROBUST STÅLKONSTRUKTION



Mer information

2570,-

→ **Ø 10 MM
X 20 M**

Tekniska data:

max. tryck:	12 bar
Slanglängd:	20 + 2 m
Inre slangdiameter:	10 mm
Anslutningsgångning:	3/8"
Tillåtet Temperaturområde:	-40 - 60 °C

515.3425 Tryckluftsslang-upprullare



Hybrid polymer-slang

20 m



2 m



3/8"

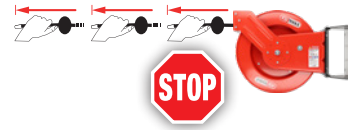

180°

Automatisk tryckluftsslangvinda



Mer information

515.3440

1790,-

Tekniska data:

max. tryck:	20,0 bar
Slanglängd:	15 + 1,5 m
Inre slangdiameter:	10,0 mm
Anslutningsgångning:	1/4"



15 m

1,5 m



180°

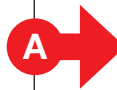

**Ø 10 MM
X 15 M**



Mer information

515.3445

2690,-

Tekniska data:

max. tryck:	20,0 bar
Slanglängd:	15 + 1,5 m
Inre slangdiameter:	13,0 mm
Anslutningsgångning:	3/8"



**Ø 13 MM
X 15 M**



Mer information

3 5000 rpm, 57 dB, 4,9 m/s, 56,9 W



Ø 440 mm

2 4500 rpm, 51,5 dB, 4,3 m/s, 53 W



1 4000 rpm, 48 dB, 3,5 m/s, 49 W



760,-

**EXTREM TYST
ULTRALÄTT
< 3,5 KG**

Luftflöde: 3 900 m³/h



610 mm

570 mm

160 mm

999.2000 Verkstadsfläkt, 70 Watt



Mer information

Skruvstäd

**TOP
SELLER**

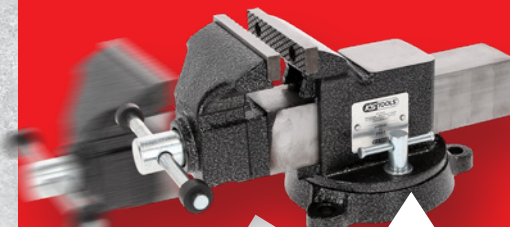

Backar och smidesstöd
induktivt härdade

från **2480,-**

914.0004	120 mm	4"	2480,- SEK
914.0005	140 mm	5"	2680,- SEK
914.0006	160 mm	6"	2830,- SEK
914.0008	200 mm	8"	3430,- SEK

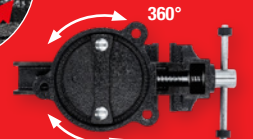

med vridskiva

1

Mer information

480 mm
320 mm
36 mm
1.150 mm
550 mm
36 mm

från 180,-

A	500.8040	480 mm	180,- SEK
B	500.8045	1.150 mm	600,- SEK

1

Mer information

420 - 540 mm

900,-

500.8030

2

Mer information

490 mm
1.040 mm
85 mm
400 mm

1040,-

500.8011

3

Mer information

1.200 mm
145 mm
420 mm
510 mm
145 mm

1500,-

500.8000

	1	2	3	4
Tekniska data:	500.8030	500.8011	500.8000	500.8090
Färg	röd	röd	röd	röd
Material	metall	metall	metall	plast
antal länkrullar	5	6	6	6
rullbar	✓	✓	✓	✓
däcktyp	plast	plast	plast	plast
vaderad	✓	✓	✓	✗
justerbar i höjd	✓	✓	✓	✗
förpackningens innehåll	1	1	1	1
totallängd L i mm	370,0 mm	1040,0 mm	1200,0 mm	1030,0 mm
bredd B	370,0 mm	490,0 mm	420,0 mm	480,0 mm
höjd H	420,0 - 540,0 mm	85,0 - 400,0 mm	145,0 - 510,0 mm	115,0 mm
total dragkraft kg	90 kg	90 kg	90 kg	120 kg

4

Mer information

480 mm
1.030 mm
115 mm

1010,-

500.8090

i  **3**
Mer information

Genialiskt flexibel

670,-

500.8077 Sats med verktygsfack av silikon

1 53 x 29,5 x 3,2 cm

2 25,5 x 23,3 x 2,4 cm

3 27,5 x 14,5 x 2,4 cm

i  **38**
Mer information

12 justerbara hållare vardera för 1/4 tums, 3/8 tums och 1/2 tums hylsor

210,-

800.0185 Magnetiskt hylsorganiseringsystem

12 x 1/4"

12 x 1/2"

12 x 3/8"

30 x 15,5 cm

i  **1**
Mer information

NEW

14 kg

90 mm

122 mm

220,-

800.0145 Magnethållare för mutterdragare

i  **1**
Mer information

10-18 kg

Ø 72 mm

10 - 18 kg

140,-

800.0165 Magnethållare

i  **1**
Mer information

Magnetmatta

320 mm

100 mm

140,-

800.0180

i  **1**
Mer information

Magnetmatta

320 mm

245 mm

280,-

800.0175



från
510,-



			L	B	H	📦		
A	800.0975		1	380 mm	405 mm	275 mm	150 kg	510,- SEK
B	800.0965		1	620 mm	440 mm	600 mm	150 kg	830,- SEK
C	800.0960		1	1270 mm	446 mm	495 mm	150 kg	1500,- SEK
D	800.0985		1	1650 mm	380 mm	730 mm	150 kg	2000,- SEK

- med profil av räfflad plåt på steget
- Ingen tippning på grund av sneda ståndfötter
- Kan beträdas från båda sidor
- fällbar och därmed platsbesparande vid förvaring
- Plastkanter på fötterna skyddar löp plattformen och marken

Mer information

780,-

140.2226

Mer information

2690,-

500.8100

Mer information

XXL

17880,-

865.0201

XXL-Arbeitsbank med 3 lådor och dörr

i **1**
Mer information

max. 3-7 h, 2,5 h, IP45, +, 🔊

GIGANTISKT LITEN, ENORMT LJUS!

70 Lumen

114 mm

MAX. 500 LUMEN

USB C, 🔊, AL

270,-

150.4530 UltimateBEAM LED-inspektionslampa av aluminium, litiumjon, 500 lumen

i **1**
Mer information

max. 2-4,5 h, +, 🔊, 1,5 h, IP20

KOMPAKT OCH ROBUST

150 Lumen

160 mm

280,-

70 Lumen

150.4540 UltimateBEAM LED-stiftlampa i aluminium, litiumjon, 150 lumen

i **1**
Mer information

max. 3 h, 3 h, IP20, +, 🔊

UV LED, med laserpekare

MAX. 350 Lumen

165 mm

uppladdningsbar med USB-C-kabel (ingår)

240,-

150.4400 LED COB Stripe inspektionslampa 350 Lumen med UV-spot-LED och laserpekare

i **1**
Mer information

25 m, max. 10 h, IPX3, +

85 Lumen

140 mm

25 m

210,-

150.4370 perfectLight ficklampa 85 Lumen

Modi	COB 100%	COB 40%	COB rot	XPE 100%	XPE 40%
LED	270° 3 Watt COB LED			1 Watt High Power XPE LED	
40% 🔊 100%	350 LM	150 LM	-	100 LM	40 LM
🕒	3 h	6 h	8 h	4 h	8 h



i **1**
Mer information

Sensoromkopplare On/Off, USB-C, Power Display, Rörelsesensor

MAX. 100 Lumen, MAX. 350 Lumen

270°

ON/OFF

Storleksjustering, XPE LED 2 ljusnivåer, COB LED 3 ljusnivåer

210,-

40 - 350 Lumen, 4,5 h, +, 🔊, max. 8 h, IPX4, 95 g

150.4520

Mer information

250,-

TOP SELLER

360°

250 Lumen

500 Lumen

USB

ON OFF

1 200 mAh litiumjonbatteri (ingår)

180°

eller

3x AAA-batterier (ingår ej i leveransen)

inklusive USB powerbank-funktion

20 %	●
40 %	●●
60 %	●●●
80 %	●●●●
100 %	●●●●●

150.4510

max. 3 h

3 h

IP65

Mer information

280,-

max. 3 h

3 h

IP65

USB-A OUT

USB-C IN

ON OFF

130 Lumen

300 Lumen

USB-A OUT

power-bank-funktion

integrerat litium-jonbatteri 1.200 mAh

20 %	●
40 %	●●
60 %	●●●
80 %	●●●●
100 %	●●●●●

150.4505

Mer information

240,-

60 Lumen

150 Lumen

max. 3,5 h

2,5 h

IP20

360°

Micro USB

ON OFF

20 %	●
40 %	●●
60 %	●●●
80 %	●●●●
100 %	●●●●●

150.4495

Mer information

540,-

max. 3,5 h

3 h

IP65

USB-A OUT

USB-C IN

250 Lumen

550 Lumen

360°

20 %	●
40 %	●●
60 %	●●●
80 %	●●●●
100 %	●●●●●

150.4490

i **1** **Mer information**

max. 8 bar (116 PSI) 60° C / 140° F

1 Water 2 Detergent 3

Max. 40° C Max.

4 5 ↓ Switch

↑ ↓ Lock

280,-

150.8271 Tryck-pump-skum-sprayer (skummare)

i **1** **Mer information**

350 mm

650 mm

1270,-

500.8013 Transportabel pall

i **1** **Mer information**

6,3 bar 96 L/min 92 dbA 1/4" PT

145 mm 3/8" - Ø 10 mm

600,-

sug blås

515.5090 Tryckluft-sugblåspistol

i **1** **Mer information**

Ø 88 mm

5/16" x 24F

15 mm

110,-

515.5481 Folieraderare

i **1** **Mer information**

FÖR MATT LACK

Ø 88 mm

5/16" x 24F

15 mm

140,-

515.5491 Gummi-rondell för matt lack

i **10** **Mer information**

SET-PRIS = 10X

870,-

515.5486

i **10** **Mer information**









SET-PRIS = 10X

1160,-

515.5496

DEN UNIVERSELLA

i  
Mer information

			
			
1/4" PT	80 L/min	6,3 bar 90 psi	
3/8" 10 mm	102 dbA	91 dbA	



560,-

515.5595 Tryckluft-rengöringspistol

FÖR DETALJER

i  
Mer information

			
			
1/4" PT	80 L/min	6,3 bar 90 psi	
3/8" 10 mm	102 dbA	91 dbA	



820,-

515.5575

i  
Mer information

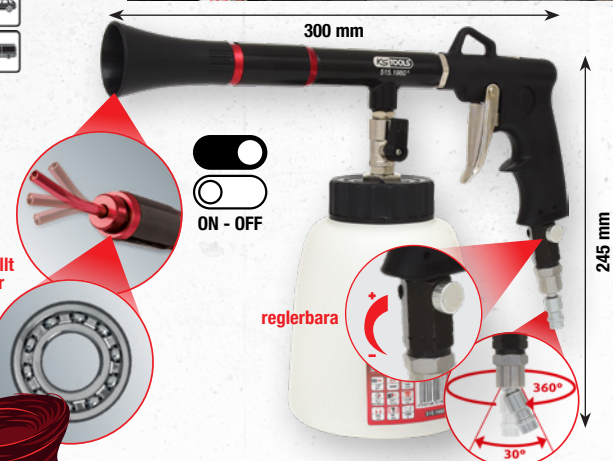

2120,-

515.1980 Tryckluft-blåsmunstycke

i  
Mer information

			
			
1/4" PT	300 L/m	6,3 bar (90 psi)	max. 15 bar

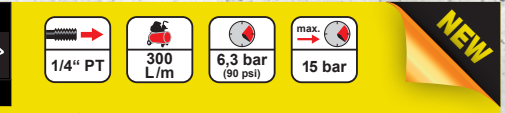









500,-

FLEXIBEL TILL SPETSEN

515.1914 Trycklufts-blåspistol med flexibelt munstycke

i  
Mer information

			
			
1/4" NPT	8000	160 L/min	
6,3 bar (90psi)	3/8" 10 mm	<3,90 m/s²	
106 dbA	95 dbA	1000 ml	

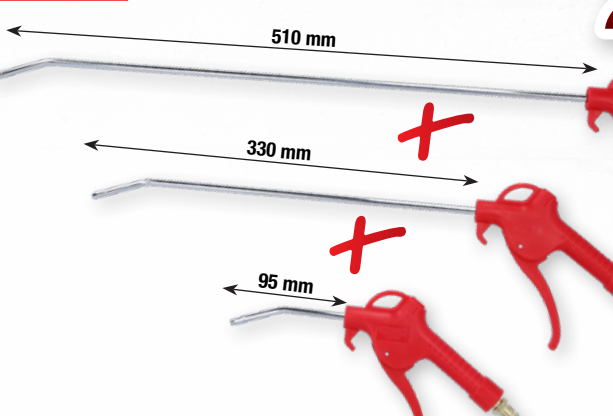
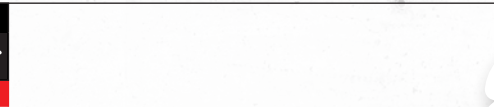

280,-

515.1921 Tryckluft-blåsmunstycke-sats

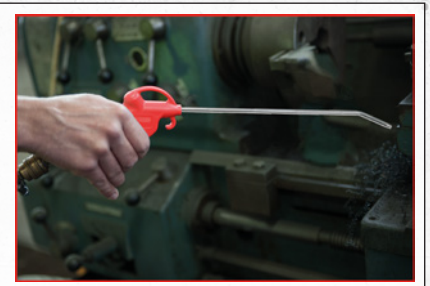

i **23**
Mer information

M8 x 50 mm
Ø 10,2 mm

1x 17/19 mm 1x 18/20 mm 1x 18,2/22,5 mm

1x 26,7/24 mm 1x 26/32 mm 1x 29,3/27 mm 1x 38,9/28,1 mm

710,-

140.2650 Hålstans-sats för avståndssensorer (PDC)

i **1**
Mer information

50 mm

8 mm Svetspunktsbör för hård metall

332.0418

890,-

NEW

i **1**
Mer information

44 mm

8 mm Svetspunktsfräs för hård metall

332.0428

890,-

NEW

i **2**
Mer information

HELT I METALL

25 mm

175 mm

630,-

911.8230 Universal-kit monteringsjärn

i **6**
Mer information

450,-

510 mm

4 mm

8 mm

10 mm

4 mm

8 mm

10 mm

245 mm

140.2370

i **5**
Mer information

250,-

180 mm

180 mm

160 mm

200 mm

210 mm

911.8120 Plastkilsats

i **11**
Mer information

280,-

180 mm

200 mm

200 mm

200 mm

180 mm

200 mm

200 mm

911.8205 MASTER plastkil-sats

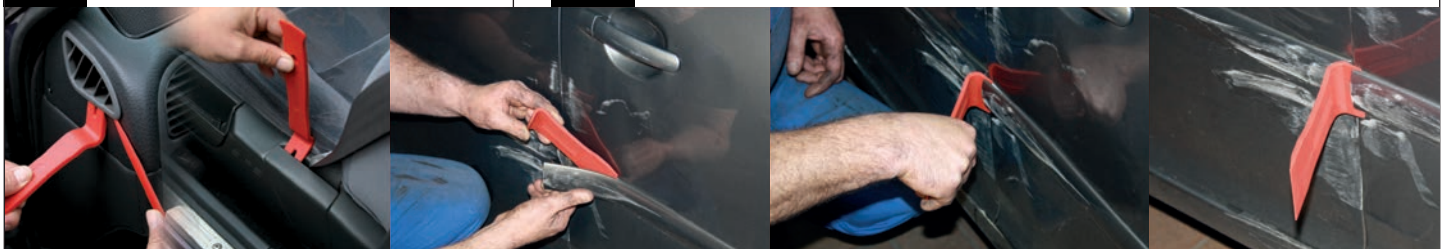



BY KSTOOLS

COMPETITION



**MAXIMAL
KVALITET
TILL BÄSTA
PRIS.**

**MAXIMUM QUALITY
AT THE BEST PRICE.**

PERFECT FÖR ALLA SOM
KAN FATTA SMARTA BESLUT
UTAN RÅDGIVNING.



PERFECT FOR THOSE WHO CAN MAKE
SMART DECISIONS WITHOUT ADVICE



**DU AVSTÅR
MEDVETET FRÅN:**

- ⊖ GOODWILL ⊖ REPARATION ⊖ OMKALIBRERING
- ⊖ EFTERKÖP AV ENSKILDA DELAR

YOU CONSCIOUSLY DO WITHOUT:

- ⊖ GOODWILL ⊖ REPAIR ⊖ RECALIBRATION
- ⊖ PURCHASE OF SPARE PARTS



512.4600



Ø
**6 mm
8 LED**



32 GB



2060,-



512.3119

119
TLG
pcs



5510,-

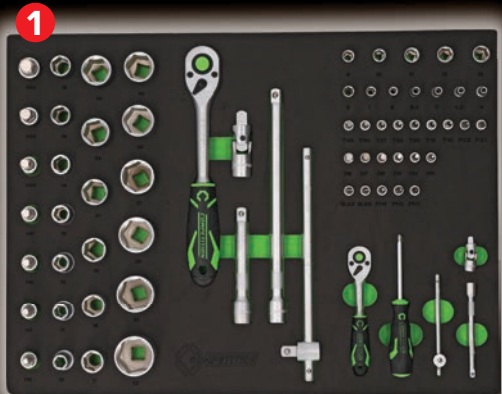

1

1/4" 4 - 4,5 - 5 - 5,5 - 6 - 7 - 8 - 9
10 - 11 - 12 - 13 mm

1/2" 10 - 11 - 12 - 13 - 14 - 15 - 16 - 17
18 - 19 - 21 - 22 - 23 - 24 - 26 - 27
28 - 30 - 32 mm



3

17 x 6 - 7 - 8 - 9 - 10 - 11 - 12 - 13
14 - 15 - 16 - 17 - 18 - 19 - 21
22 - 23 mm



2

4 x 4 - 5,5 - 6 - 8 mm

2 x PH1 - PH2

6 x T10 - T15 - T20 - T25
T30 - T40

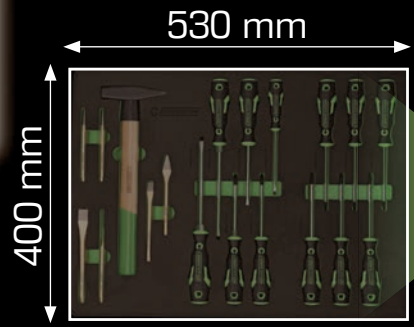



512.0207

6x7 - 8x9 - 10x12
11x13 - 14x17
19x21 - 22x23 mm



EXTRA FLAT



7
TLG
pcs

NEW!

270,-



512.0208

6x7 - 8x9 - 10x11 - 12x13
14x15 16x17 - 18x19
20x22 mm



8
TLG
pcs

210,-



512.0225

6 - 7 - 8 - 9 - 10 - 11 - 12 - 13 - 14 - 15
16 - 17 - 18 - 19 - 22 mm



15
TLG
pcs

540,-



512.0218

6x7 - 8x9 - 10x11 - 12x13 - 14x15
16x17 - 18x19 - 20x22 mm



8
TLG
pcs

270,-



512.0205

12 - 13 - 16 - 17
18 - 19 mm



XXL



72°
5°

410,-

6
TLG
pcs



512.0103

1/4"

185 - 234 mm

3/8"

248 - 350 mm

180°

1/2"

348 - 490 mm

680,-

3 TLG pcs

512.1414

NEW!

60 mm

1/4"

60 mm

540,-

2 TLG pcs

EXTREME MINI

72° 5°

SERIAL #

74026512001523090001

AB From 680,-

1/2"

	Nm	lbf·ft	Teilung/Division Nm	mm	∅ mm	↑ mm
512.0015	20-200	15-150	1,00	515,0	40,0	21,0
512.0025	60-320	45-236	1,00	590,0	40,0	21,0

512.0010

4 TLG pcs

17 mm

19 mm

21 mm

20-200 Nm

820,-

1/2"

170 mm

185 mm

1/2"

1.600 Nm

2,1 kg

512.0020

680,-

115 mm

180 mm

1/2"

1.390 Nm

1,2 kg

MINI

512.0030

820,-

170 mm

185 mm

3/4"

2.000 Nm

2,2 kg

512.0035

960,-

		MAX. Nm	MAX. Nm	U/min	m/s ²	dbA	dbA	l/min	bar	mm	PT	g
512.0020	1/2"	490,660,870	1600	8600	<17,4	100,9	89,9	169	max. 6,3	min. 10	1/4"	2100
512.0030	1/2"	270,640,960	1390	9000	<10,36	115	106	169	max. 6,3	min. 10	1/4"	1200
512.0035	3/4"	660,1010,1290	2000	8500	<17,25	100,9	91	196	max. 6,3	min. 10	1/4"	2200

512.3410

512.3420

512.3410

512.3420

10,0 m

10,0 mm

20,0 bar

210,- SEK

350,- SEK

512.5050

1/2"

max. 10 bar

-10°
+60°C

230 mm

175 mm

820,-



512.0048

48
TLG
pcs

1/4"



350,-



4 - 4,5 - 5 - 5,5 - 6
7 - 8 - 9 - 10 - 11
12 - 13 - 14 mm



512.0092

91
TLG
pcs

1/4" 3/8"



1/4" - 5/16" - 3/8"
7/16" - 1/2" - 9/16"
5/8" - 11/16" - 3/4"



1100,-



5/32" - 3/16" - 7/32" - 1/4" - 9/32" - 9/16"
19/32" - 5/8" - 11/16" - 3/4" - 25/32"
13/16" - 7/8" - 15/16" - 1" - 5/16" - 11/32"
3/8" - 7/16" - 1/2"



512.0132

132
TLG
pcs

1/4" 3/8" 1/2"



8 - 9 - 10 - 11 - 12
13 - 14 - 15 - 16
17 - 18 - 19 mm



1510,-



4 - 5 - 5,5 - 6 - 7 - 8 - 9 - 10 - 11
12 - 13 - 14 - 15 - 16 - 17 - 18
19 - 21 - 22 - 24 - 27 - 30 - 32 mm



512.0191

191
TLG
pcs

1/4" 3/8" 1/2"



1100,-



4 - 4,5 - 5 - 5,5 - 6 - 7 - 8 - 9 - 10 - 11
12 - 13 - 14 - 15 - 16 - 17 - 18 - 19
20 - 21 - 22 - 24 - 27 - 30 - 32 mm



512.0107

106
TLG
pcs

1/4"

1/2"

1230,-



8 - 9 - 10 - 11 - 13
14 - 17 - 19 mm

4 - 5 - 6 - 7 - 8 - 9 - 10 - 11 - 12
13 - 14 - 15 - 17 - 19 - 21 - 24
27 - 30 - 32 mm



512.0144

143
TLG
pcs

1/4"

1/2"



10 - 11 - 12 - 13 - 14
15 - 16 - 17 - 19 mm

1920,-

4 - 4.5 - 5 - 5.5 - 6 - 7 - 8 - 9 - 10 - 11
12 - 13 - 14 - 15 - 16 - 17 - 18 - 19
21 - 22 - 24 - 27 - 30 - 32 mm



512.0145

145
TLG
DCS

1/4"

1/2"

1920,-



4 x



8 x 8 - 10 - 11 - 12 - 13
15 - 17 - 19 mm



1/4"		4 - 4,5 - 5 - 5,5 - 6 - 7 - 8 - 9 - 10 - 11 - 12 - 13 mm
1/2"		10 - 13 - 14 - 15 - 17 - 18 - 19 - 20 - 22 - 24 - 27 mm



512.0147

147
TLG
DCS

1/4"

1/2"



9 x 1,5 - 2 - 2,5 - 3 - 4 - 5
6 - 8 - 10 mm

9 x T10 - T15 - T20 - T25 - T27
T30 - T40 - T45 - T50



6 x



1/4"		4 - 4,5 - 5 - 5,5 - 6 - 7 - 8 - 9 - 10 - 11 - 12 - 13 - 14 mm
1/2"		10 - 13 - 14 - 16 - 17 - 18 - 19 - 20 - 22 - 24 - 27 - 30 - 32 mm
6 x		8 - 10 - 12 - 15 - 17 - 19 mm

2060,-



512.0053

51

TLG
pcs

410,-

NEW!



1/4"

1 x		1/4"
12 x		4 - 5 - 5,5 - 6 - 7 - 8 - 9 - 10 - 11 - 12 - 13 - 14 mm
3 x		25 mm: 1,5 - 4,5 - 6,5 mm
1 x		75 mm: 5,5 mm
4 x		25 mm: PH1 - 2xPH2 - PH3
2 x		75 mm: PH1 - PH2
4 x		25 mm: PZ1 - 2xPZ2 - PZ3
2 x		75 mm: PZ1 - PZ2
5 x		25 mm: 2 - 3 - 4 - 5 - 6 mm
4 x		75 mm: 3 - 4 - 5 - 6 mm
7 x		25 mm: T10 - T15 - T20 - T25 - T27 - T30 - T40
3 x		75 mm: T20 - T25 - T30
1 x		1/4"
1 x		1/4", 100 mm
1 x		1/4"



512.0062

60

TLG
pcs

540,-

NEW!



1/4"

1 x		1/4"
8 x		5,5 - 6 - 7 - 8 - 10 - 11 - 12 - 13 mm
1 x		25 mm: 1,5 mm
1 x		50 mm: 5,5 mm
1 x		89 mm: 5,5 mm
3 x		25 mm: PH1 - PH2 - PH3
2 x		50 mm: PH2 - PH3
2 x		89 mm: PH1 - PH2
2 x		25 mm: PZ1 - PZ2
2 x		50 mm: PZ2 - PZ3
2 x		89 mm: PZ1 - PZ2
3 x		25 mm: 4 - 5 - 6 mm
2 x		50 mm: 3 - 4 mm
4 x		89 mm: 3 - 4 - 5 - 6 mm
6 x		25 mm: T10 - T15 - T20 - T25 - T30 - T40
5 x		50 mm: T10 - T15 - T20 - T25 - T30
3 x		89 mm: T20 - T25 - T30
1 x		1/4"
1 x		1/4"
1 x		150 mm
1 x		50 mm
1 x		50 mm
7 x		1,5 - 2 - 2,5 - 3 - 4 - 5 - 6 mm



512.3421

21

TLG
pcs

3/4"

2200,-



19 - 21 - 22 - 23 - 24 - 26 - 27 - 29
30 - 32 - 35 - 36 - 38 - 41 - 46 - 50 mm



512.0706

5

TLG
pcs



1/4"

210,-



4,5 x 125 mm
5,5 x 100 mm
7,0 x 140 mm



PH1 x 80 mm
PH2 x 100 mm



512.0603

3

TLG
pcs

8 - 10 - 13 mm



270 mm

270,-



512.0310

3

TLG
pcs



512.0405

5

TLG
pcs

270,-



320 mm

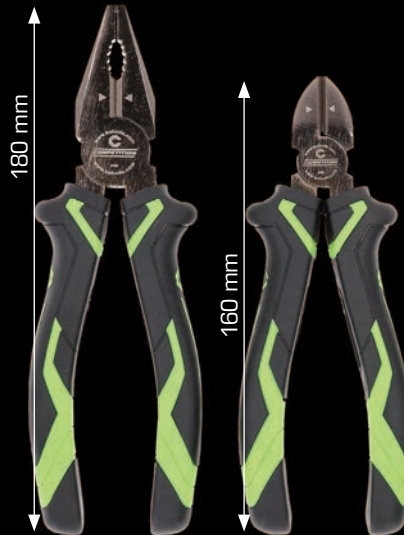

180 mm

160 mm

200 mm

270,-



512.4515

150 Lumen



512.4510

200 Lumen



500 Lumen

180 mm

270,-



1.200 Lumen

275 mm

410,-

incl. +



512.4505

120 Lumen

240 Lumen

2

TLG pcs

360 Lumen

400 Lumen

275 mm

150 mm

350,-



512.3000



490,-

2x AAA ✓

LCD				+ ✓ - ✓	$\frac{c}{a} b$
1x ✓			2 630 - 670 nm <1 mW	ABS	2 AAA 1,5 V

512.5030



320,-

NEW!



512.5065

9V +- ✓

- V~ ▶ 200 V - 600 V
- V... ▶ 200 mV - 600 V
- A... ▶ 20 μA - 10 A
- Ω ▶ 200 Ω - 2 MΩ
- F ▶ 250 mA/600 V; 10 A/600 V



130,-

NEW!



512.0510

3
TLG
pcs

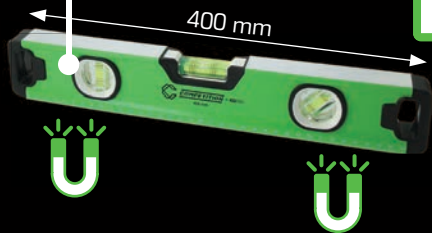
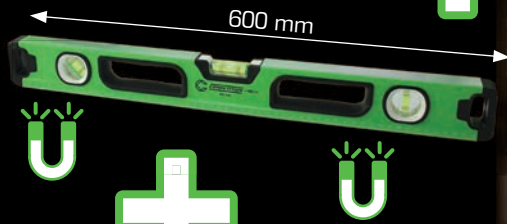
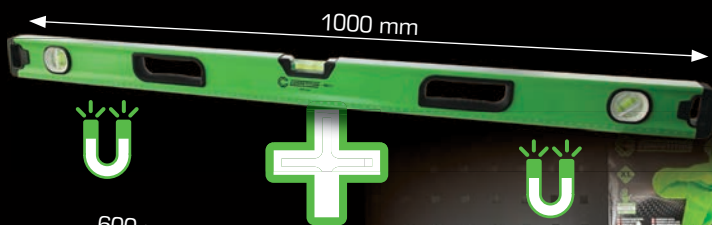
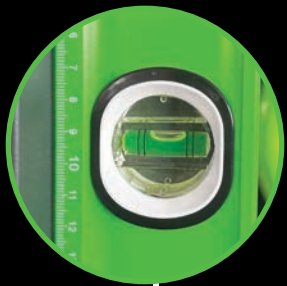

540,-



512.5060

2in1

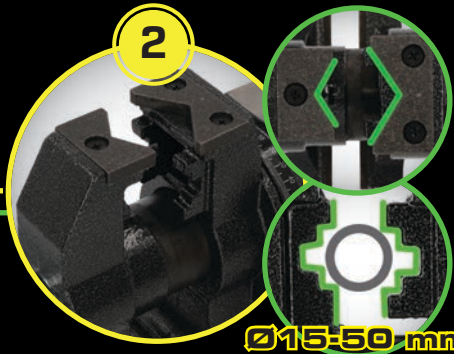

1230,-

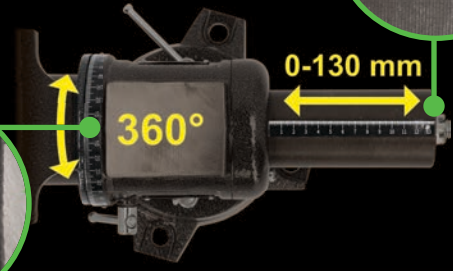
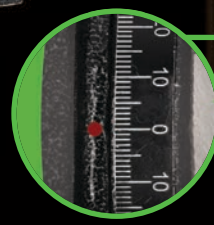



512.5090



5x		M1 - M2 - M3 - M4 - M5
1x		1/4" x 3/8"
1x		
10x		2 - 3 - 4 - 5 - 6 - 7 - 8 - 10 - 11 - 12 mm
10x		2 - 3 - 4 - 5 - 6 - 7 - 8 - 10 - 11 - 12 mm
13x		6 - 7 - 8 - 9 - 10 - 11 - 12 13 - 14 - 15 - 16 - 17 - 19 mm

820,-



NEW!

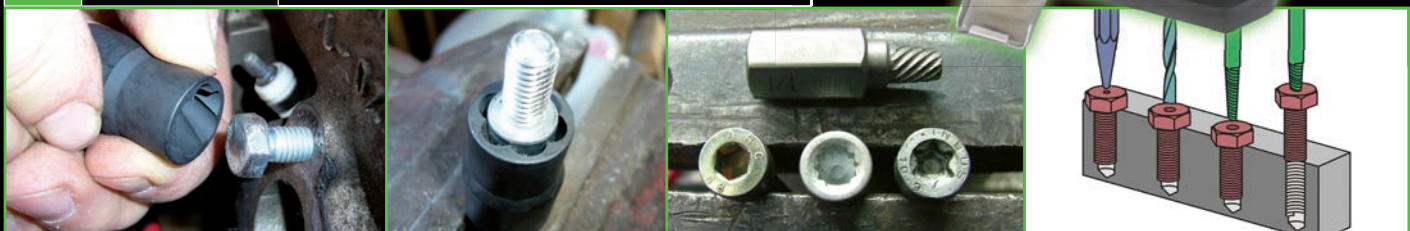

512.5070



NEW!

2x		M3 - M12 - M6 - M20
2x		M2 - M9 - M10 - M18
1x		M2 - M3
35x		M2x0,4 - M3x0,5 - M4x0,7 - M5x0,8 - M6x0,75 M6x1,0 - M7x0,75 - M7x1,0 - M8x0,75 - M8x1,0 M8x1,25 - M9x0,75 - M9x1,0 - M9x1,25 - M10x0,75 M10x1,0 - M10x1,25 - M10x1,5 - M11x0,75 - M11x1,0 M11x1,25 - M11x1,5 - M12x0,75 - M12x1,0 - M12x1,25 M12x1,5 - M12x1,75 - M14x1,0 - M14x1,25 - M14x1,5 M14x2,0 - M16x2,0 - M16x1,5 M16x1,0 - M18x1,5 mm
35x		M2x0,4 - M3x0,5 - M4x0,7 - M5x0,8 - M6x0,75 M6x1,0 - M7x0,75 - M7x1,0 - M8x0,75 - M8x1,0 M8x1,25 - M9x0,75 - M9x1,0 - M9x1,25 - M10x0,75 M10x1,0 - M10x1,25 - M10x1,5 - M11x0,75 - M11x1,0 M11x1,25 - M11x1,5 - M12x0,75 - M12x1,0 - M12x1,25 M12x1,5 - M12x1,75 - M14x1,0 - M14x1,25 - M14x1,5 M14x2,0 - M16x2,0 - M16x1,5 M16x1,0 - M18x1,5 mm

1650,-





512.5100

16
TLG
pcs

NEW!

600 ml



220V



12V

540,-



512.5101

600 ml



130,-

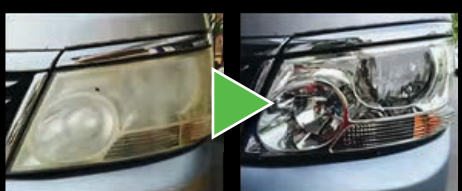
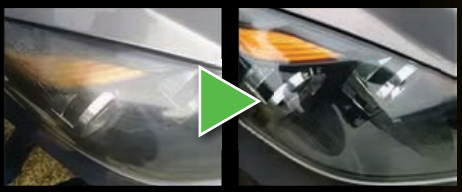



512.5080

max. 12.000 V

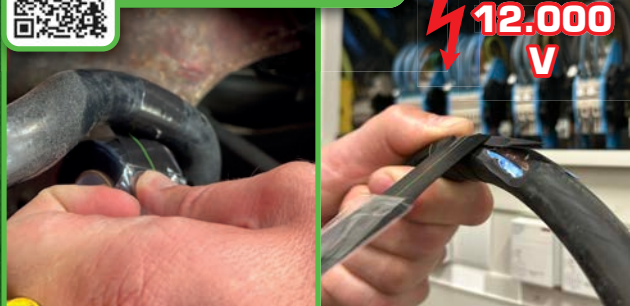

max. 12 bar



FAST REPAIR



NEW!

3.6 m

25 mm

130,-



512.5095

16 TLG OCS

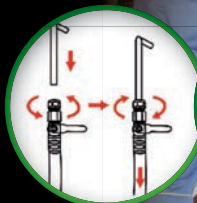

NEW!

1230,-



512.5005

500 kg



1108 - 1926 mm

2200,-

	für/for: Ford 1/8-27 NPT
	für/for: BMW, Honda, Nissan etc.
	für/for: VAG
	für/for: VAG, Porsche
	für/for: VAG, Mini Cooper M10 x 1.0
	für/for: Mercedes M12 x 1.5
	für/for: VAG DSG M24 x 1.5
	für/for: VAG CVT M22 x 1.5
	für/for: Škoda M18 x 1.5
	für/for: VAG, Škoda M30 x 1.5

	Universal Flexible 300 mm, für/for: Honda, Hyundai, Kia, etc.
	für/for: Volvo 5/16-24 (UNF)
	für/for: Toyota / Lexus M18 x 1,5
	für/for: VW, Passat ATF-Adapter
	für/for: Nissan M10 x 1,5



512.5085



27
TLG
PCS

1230,-



NEW!



2T



512.5010



820,-



NEW!



512.5015

3T



2060,-



NEW!



512.5075

3/8"

820,-

30
TLG
pcs

1x		Ø 8 x 10 - 12 x 10 mm
1x		3/8" x 1/2"
28x		Ø: 65x14F - 66/68x14F - 66x6F - 68x14F - 73x14F 74x15F - 74/76x15F - 76x8F - 76x12F - 76x14F 76x30F - 78x15F - 80x15F - 80/82x15F - 86x16F - 86x18F 90x15F - 92x10F - 93x15F - 93x36F - 93x45F - 95x15F 96x18F - 100x15F - 106x15F - 108x15F - 108x18F

NEW!



6
mil

CE 2777
EN ISO 374-1:2016+A1:2018

50
TLG
pcs



Verkauf
nur in vollen
VPE's
à 10 Boxen
Sale only in full PUs of 10 boxes



512.04620P	M	95±10 mm	50	690,- SEK
512.04630P	L	110±10 mm	50	690,- SEK
512.04640P	XL	120±10 mm	50	690,- SEK



512.0600



410,-

i **303**
Mer information

45°

MAX. 600°C

50 x V Ø 0,6 mm

50 x U Ø 0,6 mm

50 x W Ø 0,6 mm

50 x V Ø 0,8 mm

50 x U Ø 0,8 mm

50 x W Ø 0,8 mm

i
En batteriladdning räcker för ca 300 reparationsklämmor

1410,-

DC 5V 2A

600°C max

3,7 V 30 W

4.000 mAh

3 h

≈300x

150.1065 **Plastreparation-sats (kablös)**

i **150**
Mer information

för TESLA

180,-

	OE*		OE*	
01	1021886-00-A	10 x	09	1047307-00-A 10 x
02	1098408-00-B	10 x	10	1014969-00-A 10 x
03	1110713-99-C	10 x	11	1092696-00-B 10 x
04	1006521-00-A	10 x	12	1128034-00-B 10 x
05	1006535-00-A	10 x	13	1135147-00-A 10 x
06	Universal	10 x	14	1025401-00-A 10 x
07	1016078-00-A	10 x	15	1020213-00-A 10 x
08	1011813-00-A	10 x		

De visade OE-numren fungerar enbart för tilldelning av tekniska data och användningssyften.

420.0790

NEW

i **1**
Mer information

för VOLVO

550,-

140.2152 **Inställningsverktyg för radarsensorer för Volvo**

i **1**
Mer information

för VOLVO

720,-

140.2153 **Inställningsverktyg för parkerings-assistentkamera för Volvo**

i **1**
Mer information

för TESLA

för demontering av den övre panelen på baklampan

22 mm

130,-

10

3/8"

150.8101 **Special-demonteringsverktyg för baklampor för Tesla Model 3**

i  **1**
Mer information



250 mm
630 mm
Ø 3 - 43 mm

1160,-

115.0908 Universell-Slangklämtång med bowdenkabel

i  **1**
Mer information



180 mm
25 mm
Ø 10 - 30 mm

470,-

115.0907 Slangklämertång för självålsande klämmor

i  **7**
Mer information



1200,-

Ø 0 - 65 mm
Ø 0 - 48,5 mm
Ø 0 - 45 mm
Ø 0 - 38 mm
Ø 0 - 30 mm
Ø 0 - 45 mm
Ø 0 - 60 mm

115.1055 Bilslangklämtång-sats

i  **2**
Mer information

• lämplig för lossning av åtsittande slangar
• Låg kraftinsats
• Enkel betjäning
• Med plasthandtag
• Speciellt-verktygsstål



45°
125 mm
245 mm

360,-

150.2465 Slang-lossnings-verktygs-kit

NEW

i  **36**
Mer information

ANDRA SÖKER. DU HITTAR!

Tekniska data:

Strömförsörjning:	12 V DC (fordonsbatteri) eller KS Tools eMONSTER-batteri
Röckapacitet:	20 - 30 ml/min
Användningstid:	10-25 min (med 10-20 ml olja)
Kyttid:	10-20 min

5010,-

eMONSTER

OPTIONELLT

Rökolja
250 ml

140,-

550.1483

Rökmaskin för
läcksökning,
med 2 Ah-batteri

550.1470



1 **eMONSTER**
inkl. 2.0 Ah batteri

2
eller med
batterianslutningar

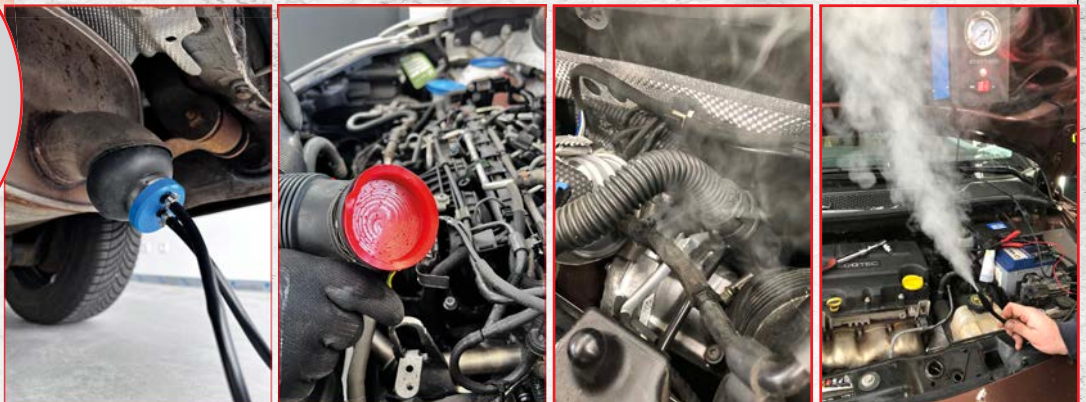

i  **1**
Mer information

13 mm

166 mm

180,-

3/8"

för
VAG

150.2518

Special-hylsnyckel för
sugrörs-skruvförband för VAG

i  **3**
Mer information

160,-

Ø 15 mm Ø 30 mm Ø 60 mm

150 mm 180 mm 250 mm

115.5050

i  **3**
Mer information

Ø 15 mm Ø 35 mm Ø 23 mm

155 mm 225 mm 165 mm

115.5055

180,-

i  **1**
Mer information



210,-

150.9221 Utsugnings- och påfyllnings-handpump

0,2L

i  **1**
Mer information

210,-



27 mm



Ø 60 mm

12

för AUDI E-TRON

150.1924 Special-hylsa för demontering av kylarvätskebehållaren för Audi

i  **1**
Mer information

NEW



250,-



1/2"

100 mm

6x

för BMW

150.2384 Kylarlock utdragnings verktyg för BMW

i  **1**
Mer information



180,-



1/2"

108 mm

7x

för VAG

150.1919 Kylarlock utdragnings verktyg för VAG

i  **1**
Mer information

PETROL **DIESEL** **OIL**



280,-



Ø 12 mm
1.500 mm

12,0 V

Ø 6 mm
1.200 mm

150.2820 Elektrisk oljeuppsugnings- och överföringspump

i **8**
Mer information

250 ml

1500,- **210,-**
150.1914

OPTIONELLT

150.1910 CO2-cylinderhuvud-läckagetest-sats

i **5**
Mer information

8 mm **10 mm** **12 mm**

1/4"

1 = 10 Nm
2 = 20 Nm
3 = 30 Nm
4 = 40 Nm

1/4" PT

10-40 Nm

3980,-

152.1060 Glödstift-tryckluft-vibrationskrav-sats

i **4**
Mer information

97 mm **3/8"**

14 mm **16 mm** **18 mm** **21 mm**

540,-

Tändstiftshylssats, magnetisk och ledad

517.1145 3/8" 14 - 16 - 18 - 21 mm

VARJE GNISTA RÄKNAS!

i **2**
Mer information

180 mm **215 mm**

14 mm **16 mm**

360,-

FÖR FORD ECOBOOST-MOTORER 1,0 LITER

FÖR FORD ECOBOOST-MOTORER 1,5 LITER

Tändstiftshylssats för EcoBoost-motorer

517.1135 3/8"



Mer information

- för skärning av rostiga och skadade sondgångar
- idealisk för NOX- och partikelfiltersensorer på avgassystem
- med 6 skäreppor för idealisk centring
- särskilt kort konstruktion
- med rengöringsspar i styrappen

2690,-

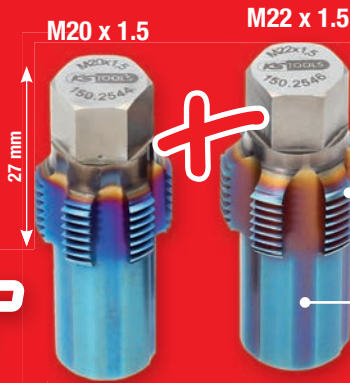

med 6 skäreppor för idealisk centring

med rengöringsspar i styrappen



150.2540 Gängskärarsats med styrstift för sensorer



Mer information

Gängtapp med styrhylsa

- för skärning av rostiga och skadade sondgångar

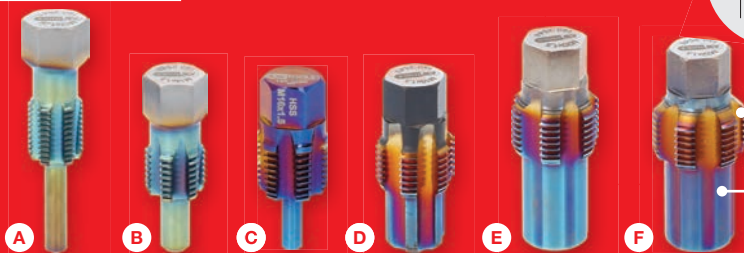

med 6 skäreppor för idealisk centring

med rengöringsspar i styrappen

1500,-

				L1	L2		
A	150.2541	för temperatursensorer	M12 x 1,25	55 mm	33 mm	13 mm	1500,- SEK
B	150.2542	för temperatursensorer	M14 x 1,5	45 mm	30 mm	13 mm	1500,- SEK
C	150.2556	för temperatursensorer	M16 x 1,5	43 mm	28 mm	13 mm	1500,- SEK
D	150.2543	för lambdasonder	M18 x 1,5	42 mm	27 mm	13 mm	1500,- SEK
E	150.2544	för NOX-sensorer	M20 x 1,5	50 mm	27 mm	13 mm	1500,- SEK
F	150.2546	för partikelfiltersensorer	M22 x 1,5	50 mm	27 mm	13 mm	1500,- SEK

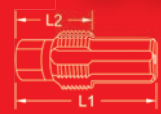

Mer information

<p>M12 x 1,25 </p> <p>A</p> <p>för NISSAN, RENAULT, BMW, MINI, CITROËN, PEUGEOT, FORD, HYUNDAI, KIA, DACIA, MERCEDES, OPEL, VAUXHALL, SUZUKI, IVECO</p>	<p>M14 x 1,5 </p> <p>B</p> <p>för MERCEDES, AUDI, PORSCHE, SEAT, ŠKODA, VW, FIAT, ALFA ROMEO, LACIA, OPEL</p>	<p>M16 x 1,5 </p> <p>C</p> <p>för MERCEDES, DAF</p>	<p>M18 x 1,5 </p> <p>D</p> <p>för MERCEDES, AUDI, PORSCHE, SEAT, ŠKODA, VW, FIAT, ALFA ROMEO, LANCIA, BMW, OPEL, CHEVROLET, DAEWOO, SUZUKI, FORD, HONDA, TOYOTA, NISSAN, VOLVO, CITROËN, SAAB, SUBARU, MAZDA, MINI, MITSUBISHI, JAGUAR, ROLLS ROYCE, BENTLEY, LEXUS, PONTIAC</p>
--	--	--	---



<p>M20 x 1,5 </p> <p>E</p> <p>för BMW, AUDI, VW, OPEL, MERCEDES</p> <p>för MERCEDES, IVECO, MAN, SCANIA, RENAULT, VOLVO</p>	<p>M22 x 1,5 </p> <p>F</p> <p>för AUDI, VW, PORSCHE, OPEL, MERCEDES, BMW, GENERAL MOTORS, MAN</p>
--	--



med 6 skäreppor för idealisk centring

med rengöringsspar i styrappen

6200,-



6 x

Specialjackmutter för montering och avmontering av svårtillgängliga lambdasonder

150.2550 Master-reparations-verktygssats för avgassonder

i **7**
Mer information

Ø 6x600 mm + Ø 9x600 mm

Förbindningslang- och sugrats

Tryck- och undertryckspump

120 ml

Droppmätningstågare 120 ml, med dubbelt slanganslutningslock

120 ml

Leveransmätningstågare 120 ml, med lock

4x

Förbindningsstift-set (6x4 / 6x6 / 6x8 / 6x10)

3x

Bromsavluftningsventil-adapter

11x

Kon-slangadapter

2060,-

150.1900 Tryck- och undertryckspumpsats

i **24**
Mer information

Adapter
Stålhylsa
Adapterhylsa
Skruvmutter

760,-

114 mm

70 mm

A	Grundkropp	
B	Utdragningskrok	70 mm / 114 mm
C	Adapter	Ø 27,6 - 33,6 - 41,9 - 45,9 48,9 - 56,0 - 64,0 mm
D	Stålhylsa	Ø 10 - 18 - 22 27 mm
E	Adapterhylsa	
F	Skruvmutter	Ø 8,1 - 10,2 - 12,2 - 14,2 16,2 18,2 - 20,2 mm

700.1280 Universal axeltätningring och packbox monterings verktyg sats

i **2**
Mer information

• lämplig för montering och demontering av elastiska V-ribbade remmar
• snabbt, problemfritt och korrekt rembyte
• inga skador på remhjulen och remmen
• minimal kraftansträngning av nylon

140,-

NEW

Montering

1 **2** **3**

Demontering

1 **2**

150.3315 Verktygssats för kilrem

i **1**
Mer information

280,-

Universal-tappnyckel för spännrulle för kuggrem, justerbar

150.3046

i **8**
Mer information

30-520 Hz **9V**

11320,-

30 - 520 Hz

Elektronisk respspanningsprovare

150.3165

i **2**
Mer information

210,-

T50

Användningsområden / för: Ford dieselmotorer 2.0L EcoBlue, 2.0L Duratorq TDCi (DW10F)

24 mm

17 mm

1/2"

24 mm

för FORD

150.3270 Generator-kombinationsnyckel-sats för Ford

i **1**
Mer information

Användningsområden / för: Citroën, Peugeot, Opel och Toyota med 1,0 och 1,2 bensinmotorer (motorkod: ZMZ (EB0F / EB0) / HM01 (1PP) / HMV, HMZ (EB2) / HMZ (EB2 / EB2F) / HMT (EB2D) / HMU (EB2D) / HNZ (EB2DT) / HNY (EB2DTS) / HMV (EB2M) / HMY (EB2M) / B12XE (EB2F) / D12XE (EB2FA) / B12XHL (EB2DT) / D12XHL, F12XHL (EB2ADT) / B12XHT (EB2DTS) / D12XHT, F12XHT (EB2ADTS))

160,-

120 mm

för PSA

400.2118 Testverktyg för kuggrem för PSA

i **7**
Mer information

Användningsområden / för: Audi A1 (8X), A3 (P), Seat Altea (5P), Leon (1P), Ibiza IV (6J, 6P), Toledo IV (KG), Skoda Fabia II (542,545), Octavia II (1Z), Rapid (NH1, NH3), Roomster (5J), Yeti (5L), Volkswagen Golf VI (5K, AJ,517), Golf Plus (5M,521), Polo V (6R, 6C), Jetta VI (162, 163, AV), Caddy III (2K, 2C), Beetle (5C), Touran (1T)
Motorkoder: 2.0L TSI / TFSI (CBZA, CBZB, CBZC)

3230,-

för VAG

90 mm

220 mm

M14 x 1,5

27 mm

15 mm

0 50 mm

0 47 mm

400.0910 Monteringsverktygssats för drev för VAG

NEW

i **2**
Mer information

för **MERCEDES, AUDI, SEAT, SKODA, BMW, VOLKSWAGEN**

3/8" **3/8"**

8 mm **8 mm**

17 mm **18 mm**

• öppning möjliggör vridning om 180°
• smal diameter

390,-

405.0160 Insprutningslednings-nyckel-sats till BMW

NEW

i **15**
Mer information

• för åtdragning och lossning av röranslutningar

10 - 11 - 12 - 13 - 14 - 15 - 16 - 17 - 18 - 19 - 22 mm

3/8"

1790,-

913.3835 12-kantig hyls-blocknyckel-sats med led

i **1**
Mer information

för **BMW, MINI**

410,-

6 mm **56 mm**

115.1102 Upplåsningsverktyg för bränsleledningar för BMW och Mini

i **1**
Mer information

540,-

140 mm **45 mm**

115.0909 Upplåsningsverktyg med svängbart huvud för snabbkopplingar

i **1**
Mer information

360,-

270 mm **65 mm**

180°

115.0906 Bränslelednings-tång för snabbkopplingar med länk

i **22**
Mer information

760,-

115.1260 Kabelanslutnings-upplåsnings-sats

5/16" 1/4" 5/16" 3/8" 3/8" 1/2" 5/8" 7/8"

3/8" 1/2" 5/8" 3/4" 5/16"

3/8" 1/2" 5/8"

3/4" 7/8" 5/16" x 3/8"

5/16"



Mer information

LÄTT ATT DRA UT MED 3 873 SLAG I MINUTEN!

FÖR BOSCH ✓
FÖR DENSO ✓
FÖR DELPHI ✓
FÖR SIEMENS ✓

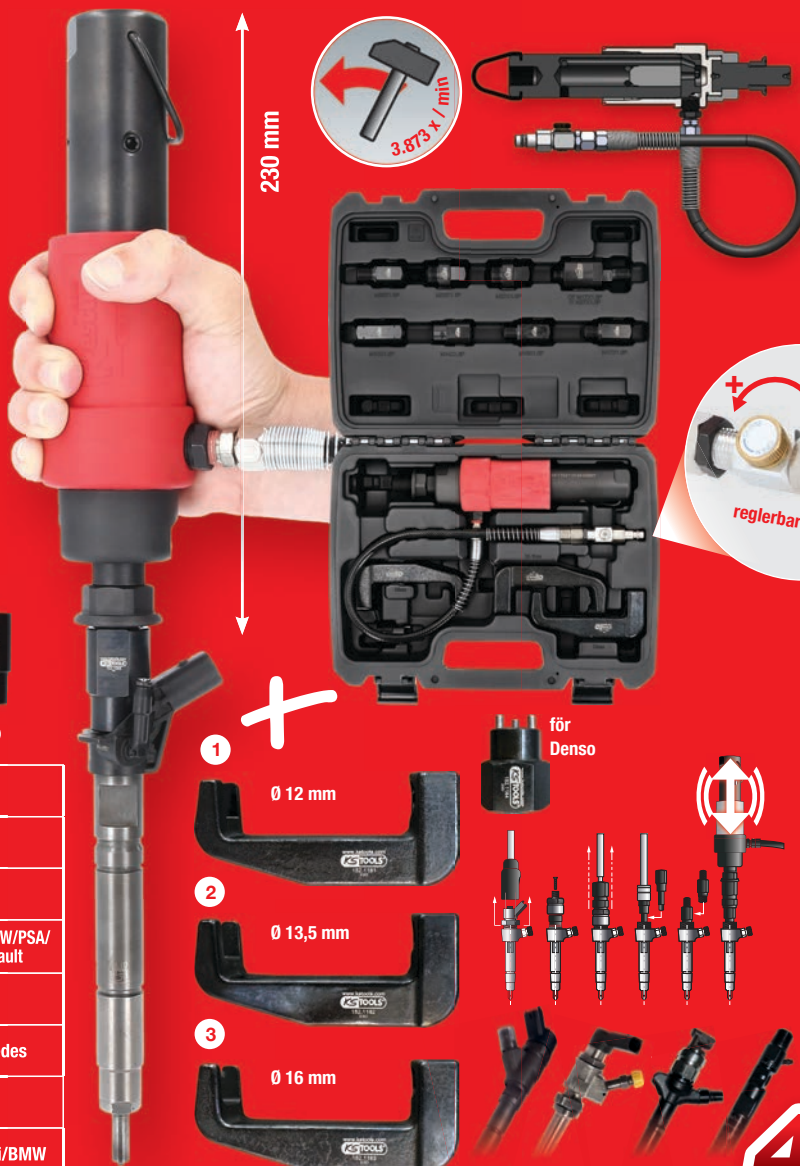

223 L/min	3/4"- 19 mm	108,4 dBa
6,3 bar (90 psi)	71,9 m/s²	6 mm
max 12 bar	119,4 dBa	M18 x 1,5

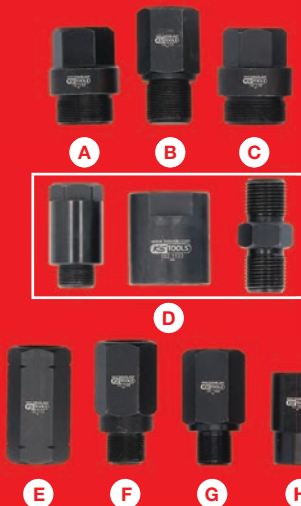
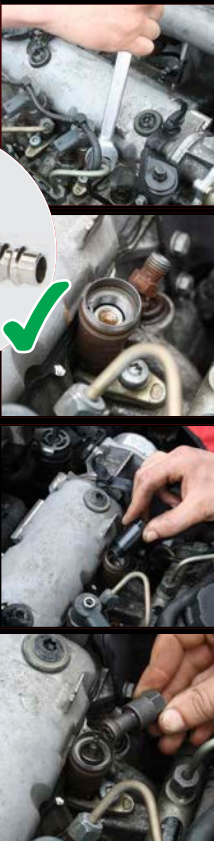

A	M25 x 1,0	för	Siemens
B	M20 x 1,0	för	Denso
C	M27 x 1,0	för	Siemens
D	M27/M17/ 10 mm	för	Bosch/Fiat/BMW/PSA/ Mercedes/Renault
E	M18 x 1,5		Adapter
F	M17 x 1,0	för	Bosch/Mercedes
G	M16 x 1,0	för	Toyota
H	M14 x 1,5	för	Bosch/Delphi/BMW

4020,-

152.1130 Utdragsarsats för tryckluftsinjektorer

FÖR FÖRLÄNGNING



Mer information

A	M8 x 1,0 - M8 x 1,25 - M10 x 1,0 M10 x 1,5 - M14 x 1,5	för	universal
B	M18 x 0,75	för	Bosch
C	M25 x 0,5	för	Denso
D	M25 x 1,5 - M27 x 1,0	för	Siemens
E	M27 x 0,75	för	Bosch
F	M29 x 1,0	för	Delphi
G	M26 x 0,75	för	Bosch CRIN 2
H	M31 x 0,75	för	Bosch CRIN 1
I	M16 x 1,0	för	Toyota
J	M20 x 1,5	för	universal
K	AG M22 x 1,2 / IG M14 x 1,5	för	Delphi

2610,-

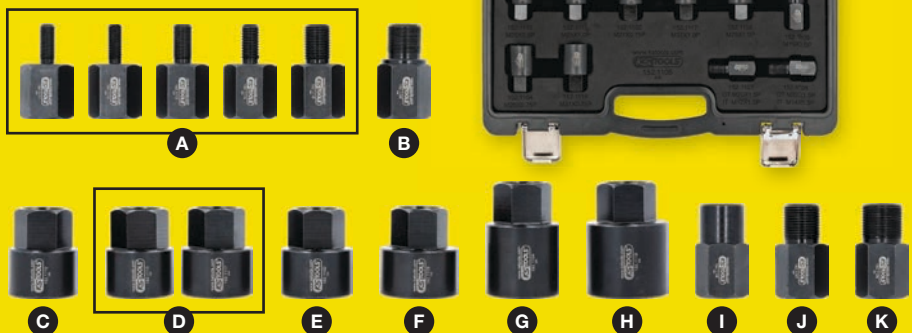

152.1105 Iskruvningsadapter-sats för injektor-utdragare



FÖRST REN SEDAN TÄT!

NEW



- Ø 19 mm
- Ø 18,4 mm
- Ø 17 mm
- Ø 19 mm
- Ø 19 mm
- Ø 21 mm
- Ø 24 mm
- Ø 14 / 14 mm
- Ø 15,5 / 15,5 mm
- Ø 15 / 19 mm
- Ø 19 / 21,5 mm
- 15,5 / 15,5 mm
- Ø 17 / 17 mm
- Ø 17 / 17 mm
- Ø 17 / 17,5 mm
- Ø 17 / 19 mm
- Ø 17,5 / 20,5 mm
- Ø 17 / 20 mm
- Ø 17 / 19 mm
- Ø 17 / 21 mm
- M5
- 2,5 mm

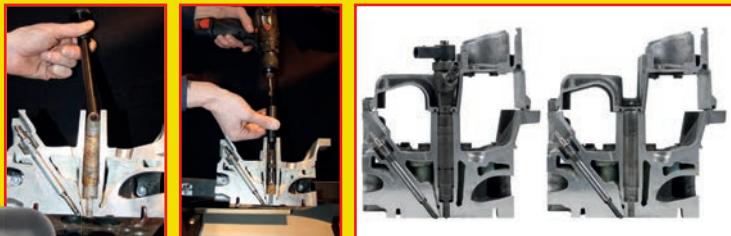

2430,-

152.1210 Master injektor-tätningsskit-rengörings-kit



360,-

115.1108 Kaptång för elektriska anslutningar



Mer information

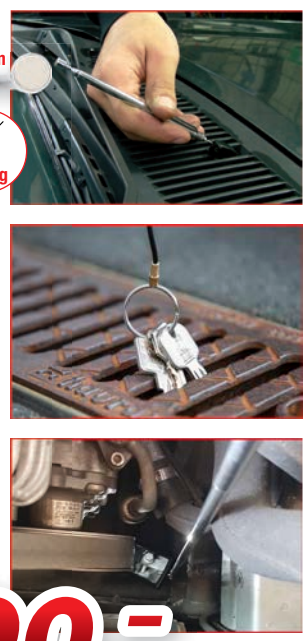
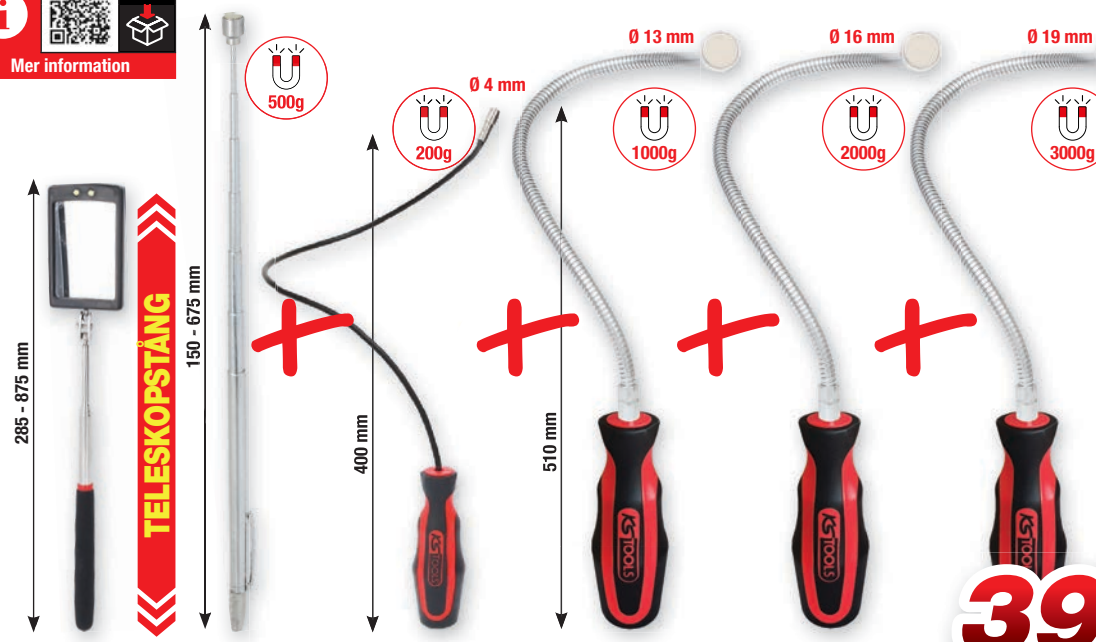

390,-

550.1090 Flexibel och teleskopisk magnethållare och inspektionsspegelset

i  **1**
Mer information



125 mm



6 - 24 V

70,-

550.1504 Testlampa 6 - 24 V

i  **1**
Mer information



140 mm



3 - 48 V

180,-

550.1503 Polaritets- och spänningstester 3 - 48 V

i  **2**
Mer information

900,-





1	Mottagare
2	Sändare med krokodilklämmor

150.3075 kortslutningsdetektor

i  **1**
Mer information

Användningsområden / för:
Audi e-tron GT (< 2021),
Porsche Taycan (< 2021)



för **AUDI, PORSCHE**



51 mm

110,-

150.1366 Lossningsverktyg för kommunikationskontakt på batterimodulen till HV-batteriet för Audi och Porsche

i  **1**
Mer information

för **VAG**



1/2"  16 mm

63 mm

110,-

150.1301 Bitshylsa insex för HV-batteriinfästningar för VAG

i  **1**
Mer information

2130,-



570 mm



för rörformade kabelskor
10 till 120 mm²



115.1410 Crimptång för batteriklämmor



Mer information

8940,-



12 V + 24 V batteri-booster -
mobilt starthjälpssaggregat 1400 A

550.1720

-
-
-
-
- 12/24 V
- 1400 A
- PEAK AMP
- 4400 A
-
-
- 1,6 m
- 35 mm²
- 2x22 Ah



1.400 A

SAFETY Xtreme



intelligent säkerhetskoncept undviker användarfel:

säkerhetskrets ger ström på plintarna först då:

- korrekt anslutning har gjorts (polaritet)
- anslutningen är kortslutningssäker
- rätt spänning ligger an
- fordonsbatteriet är OK



Mer information

14920,-

-
-
-
- 12/24 V
- 1700 A
- PEAK AMP
- 5000 A
- 1,7 m
- 50 mm²
- 2x22 Ah



12 V + 24 V batteri-booster -
mobilt starthjälpssaggregat 1700 A

550.1820



Charging control
Ladeanzeige



Mer information

- 192 x 92 x 61 mm
- 430 g
- 9 V
-
-

- V~ ▶ 6 V - 750 V
- A~ ▶ 60 mA - 20 A
- V... ▶ 600 mV - 1000 V
- A... ▶ 60 mA - 20 A
- Ω ▶ 600 Ω - 60 MΩ
- F ▶ 600 mA/1000V (32x6 mm)
- ▶ 20 A/1000 V (38x10 mm)



1650,-



117.0215 Digital multimeter inkl. testspetsar med integrerat stötskydd



Mer information

ecoLine

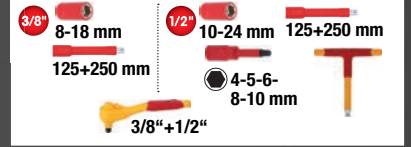
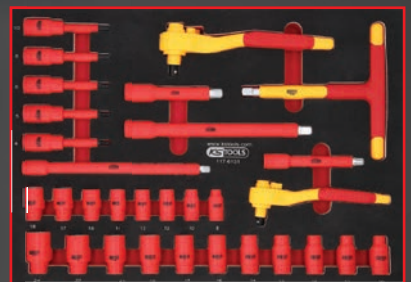
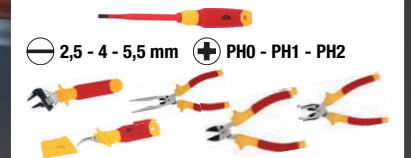

19350,-



117.0222

117.0223

117.6144 ECOLine verktygsvagn med 42 isolerade verktyg för hybrid- och elfordon



Mer information

performance plus e10

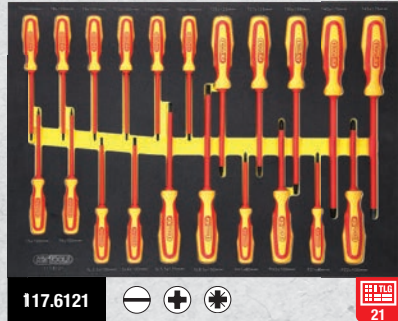

117.6121



117.6172

64040,-



117.6117



117.6133



917.3898



917.3897



117.3819



117.1660



117.1664



117.1796

117.6155 PERFORMANCEplus verktygsvagn e10 med 164 isolerade verktyg för hybrid- och elfordon



Elektromobilitätskatalogen med 188 sidor finns på www.kstools.com

i   

Mer information

160,-

A Takschild med blixtsymbol och sugkopp

117.0223

i   

Mer information

160,-

B Takschild med blixtsymbol och magnet

117.0222

i   

Mer information

210,-

C Schild med blixtsymbol

117.0226

i  

Mer information

1040,-

D Avspärringsstolpe-sats med kedja

117.1550

i  

Mer information

2090,-

E Saxlås av plast

117.1545

i **26**
Mer information

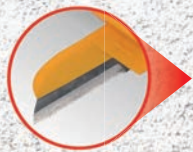

4920,-

3/8"

117.1895 Verktogsats med isolerade verktyg för hybrid- och elfordon



- 2 x 4 mm - 5,5 mm
- 2 x PH1 - PH2
- 6 x 6 - 8 - 10 - 12 - 13 - 17 mm
- 1 x 185 mm
- 1 x 165 mm
- 1 x 3/8"
- 1 x 3/8": 200 mm
- 1 x 3/8": 125 mm
- 10 x 3/8": 6 - 10 - 11 - 12 - 13 - 14 - 16 - 17 - 19 - 22 mm
- 1 x 200 mm

i **43**
Mer information



3/8"

8420,-

117.1890 Verktogsats med isolerade verktyg för hybrid- och elfordon



- 4 x 2,5 - 3 - 3,5 - 4 mm
- 3 x PH1 - PH2 - PH3
- 3 x T20 - T25 - T30



- 2 x 10 - 25 mm
- 1 x 3/8"
- 15 x 6 - 22 mm
- 2 x 150 - 250 mm
- 3 x M8 - M10 - M12
- 1 x 500 m



i **1**
Mer information

NEW

1230,-



<110.000 V



med väggfäste



KAN RÄDDA LIV!

117.0913 Isolerad räddningsstånd

i **2**
Mer information



med 4 långgående spår, 3 bälteshållare och integrerad bälteskasset med viskosbroms



1430,-

117.1555 Stolpe för avspärningsband

max. 2,50 m

1018 mm

Aluminium

2x

3x

1x

40 mm

80 mm

OPTIONAL

Vägghållare för avspärningsrem

117.1556

110,-

10 KG Ø 350 mm

10 KG Ø 350 mm

i  **4**
Mer information

130,-

Ø 22,0 - 28,0 mm

Ø 15,0 - 21,0 mm

Ø 17,0 - 25,0 mm

Kopplings-centrering-verktyg-sats

150.2180 Ø 15,0 - 28,0 mm



i  **1**
Mer information

för **AUDI, PORSCHE, VW**

140,-

34 mm

1/4"

Specialhylsa för resttrycksventil på luftfjädring

150.9699



i  **11**
Mer information

310 mm

450 mm

150 kg

300 mm

160.0910 **Universell växellådshållarsats**

5880,-



i  **2**
Mer information

för **VAG**

- perfekt lämpad för att lossa eller koppla samman anslutningen som leder till mekatroniken
- oundgänglig för reparation av hydraulgivaren, växelväljarmodulen eller mekatroniken
- speciell längd och konstruktion
- Med plashandtag

Användningsområden / för: Audi7-växlad DSG-växellåda (märkbokstav: OCJ, OCL, OCK, ODN, ODP, OHL)

170 mm

680,-

150.2495 **Monterings- och demonteringsverktygssats för VAG DSG-insticksanslutning för mekatronik**





24



Mer information

SYSTEMATISK FYLLNING

150.9261		für/for	Ford 1/8-27 NPT
150.9262		für/for	BMW, Honda, Nissan etc.
150.9263		für/for	VAG
150.9264		für/for	VAG, Porsche
150.9265		für/for	VAG, Mini Cooper M10 x 1,0
150.9267		für/for	Mercedes M12 x 1,5
150.9268		für/for	VAG DSG M24 x 1,5
150.9269		für/for	VAG CVT M22 x 1,5
150.9271		für/for	Skoda M18 x 1,5
150.9272		für/for	VAG, Skoda M30 x 1,5
150.9273		für/for	Honda, Hyundai, Kia, 300 mm
150.9274		für/for	Volvo 5/16-24 (UNF)
150.9276		für/for	Toyota / Lexus M18 x 1,5
150.9277		für/for	Nissan / Infinity M8 x 1,0
150.9278		für/for	VW Passat ATF-Adapter
150.9562		für/for	Nissan Juke M12 x 1,25
150.9563		für/for	Mini Cooper M14 x 1,5
150.9564		für/for	Nissan M10 x 1,5
150.9566		für/for	GM M12 x 1,75
150.9567		für/for	Mercedes 725-96
150.9102		für/for	VAG 7 DSG
150.9103		für/for	VAG 7 DSG
150.9104		für/for	VAG 7 DSG

TOP

150.9105



INKLUSIVE
ADAPTERSET
MED
23
DELAR

2980,-



1

Mer information

POWERPUMP:

1000,-



- idealisk för ren, snabb och enkel utsgning, insugning och tappning av vätskor
- lämplig för motorolja, växellädsolja, hydraulolja, bromsvätska, vatten etc.
- för pneumatisk användning med en kompressor eller manuellt med integrerad handpump
- Uppsugningsförloppet avbryts automatiskt när huset är fullt så att inga vätskor svämmar över
- med integrerad övertrycksventil för högre säkerhet



160.0865

i **1**
Mer information

för MERCEDES

Användningsområden / för:
MercedesSprinter Typ 910 (framhjulsdraft) > 2018 och
E-Sprinter >2020

16 **1/2"** **106 mm**

280,-

150.9599 **Fjäderbens-fästmutter-nyckel för Mercedes**

NEW

i **1**
Mer information

för TESLA

FORM: XS
FUNKTION: XL

13 mm

63 mm

17 mm

3/8"

110,-

**3/8 hylsa till
stötdämparmontering för Tesla**

150.9597

i **1**
Mer information

3/8"

0 - 45 mm

270 mm

600,-

115.1056 **Slangklämtång för vridmomentåtdragning**

VA **FE**

i **4**
Mer information

1670,-

∅ 30 mm

160.0195 **McPherson fjäderbensstöd
för växellådslyft**

i **7**
Mer information

6 mm

1500,-

150.9545 **Special stötdämpare-monteringshjälp-sats
för stötdämpare med draganslagsfjäder**

1

2

3

4

SPÄNNING LÄTT SOM EN FJÄDER FÖR 95 % AV ALLA FORDON

SENASTE GENERATIONEN! - SENASTE GENERATIONEN!

Tryckluftsläges-fjäderspännare med underram

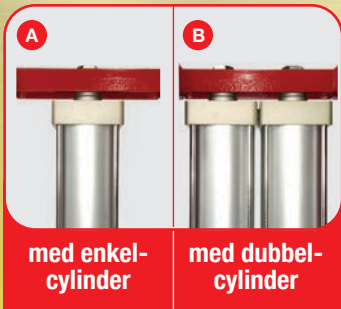

från **35870,-**

A	500.8835		med enkelcylinder		35870,- SEK
B	500.8845		med dubbelcylinder		39740,- SEK



1
Mer information

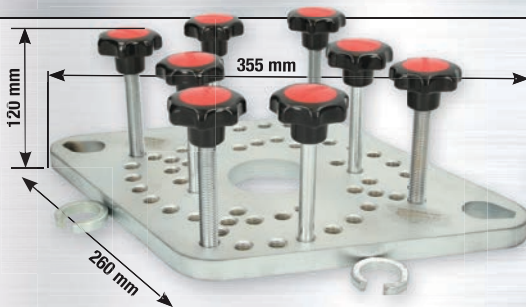

- Enkel hantering
- Speciellt-verktygsstål
- ideal för mottagning av fjäderben
- optimal för säkert stånd vid installation och borttagning
- med 4 fixeringsbultar och 4 gängade bultar
- leverans sker med 2 stoppringar för montering

500.8801 Adapterplatta för tryckluft-standard-fjäderspännare





Mer information



Universell för 90 % av alla vanliga fordonstjäderar i personbil- och transporterområdet

max. spannvidd:
355 mm

max. belastning:
26000 N

2600 kg



6730,-



Ø
140 - 195 mm

Ø
80 - 160 mm

- Bäst lämpad för säker montering och demontering av Mc Pherson fjäderben
- Nödvändig vid byte av stötdämpare eller skruvfjäder
- Prisvärd och solid alternativ till vanliga fjäderspännare

500.8400 Universal fjäderspännare-sats



Mer information



universell för 80 % av alla vanliga fordonstyper



Ø
186 mm



Ø
190 mm



Ø
200 mm



Ø
210 mm



Ø
225 mm



Ø
237 mm



TR18x3,0



27 mm

1/2"



- Möjliggör användning direkt på fordonet
- stor tidsbesparing
- universell för 80 % av alla vanliga fordonstyper
- tål extremt hög belastning
- Speciellt-verktygsstål

8130,-

500.8790 Universal McPherson fjäderspänn-sats med säkerhetsbygel





Mer information



för
**MERCEDES
FORD
BMW
VW**

Ø 95-110 mm
FÖR FJÄDERSPÄNNARE 500.8755 + 500.8765



1500,-

500.8770 par fjäderhållare Ø 95-110 mm

Användningsområden / för: Mercedes E-Klass (W211 / W212), C-Klass (W204), GLA (X156), GLK (X204), Ford Focus II (MK2), BMW 1er (E81), Volkswagen Passat (B8 / 3G)

FÖR FÖRLÅNGNING



Mer information



för
**AUDI,
SEAT**

Ø 30 mm



Ø 90 - 140 mm

5560,-



Teleskop-centreringsnyckel-sats för interna fjädrar för Audi och Seat

500.8765



WARNING - ACHTUNG - ADVARSEL
ADVERTENCIA - AVERTISSEMENT



Mer information



Ø 90 - 140 mm

Ø 30 mm

Ø 75 - 115 mm

5060,-



Universal teleskop-centerspännare-sats för inbyggande fjädrar

500.8755



-TESTAT FÖR DIN SÄKERHET!



Mer information



TR20x4,0

470 mm

Ø 30 mm

4410,-



500.8780 Universalt kit invändig fjäderspännare

i **1**
Mer information

max. 8 bar

450 mm

1/4" PT

för universalaxel-manschetter

1500,-

515.3100 Tryckluftmonteringsanordning för drivaxel damasker

i **1**
Mer information

100 mm

Ø 30 mm

760,-

150.1850 Universal länkaxel-avdragare

i **1**
Mer information

UNIVERSAL

10 mm

max. 25 Nm

5 - 14 mm

600,-

700.5662 Klämmhålexpanderer

i **1**
Mer information

SÄRSKILT LÄMPAD FÖR ELVERKTYG

27 Kg

715 mm

Ø 3 mm / 1650 mm

ISOLERAT

2610,-

700.1570 Universal-drivaxel-avdragarsats

NEW

MASSIV VERSION

i  **1**
Mer information

NEW

MINI

235 mm

1/4" PT

utrustad med 13 stift var och en på 1,4 mm

2750,-

515.3980 Mini-tryckluft-nålvrostare

i  **1**
Mer information

3610,-

330 mm

utrustad med 19 stift var och en på 3 mm

1/4" PT

515.3070 Tryckluft-nålvrostare

i  **6**
Mer information

37+ / sec.

10 mm

110 mm

10 mm

110 mm

130 mm

5510,-

515.3880 Vibro-Power tryckluft-mejselhammare-sats

i  **1**
Mer information

TOP SELLER

960 mm

Genom flexibel kedja kan knäleder i olika modeller tryckas ned säkert och utan större kraftinsats

2520,-

Universal bärmarmhållare med kedja

700.1495

i  **1**
Mer information

20 mm

600 - 915 mm

1340,-

911.8187 Teleskop ledat-rullhuvud-hävstång

i  **2**
Mer information

M12

115 mm

72 mm

210,-

515.0595 1/2" Kraftbitshyllsats för XZN skruvar

VISSA GILLAR DET VARMT!



Mer information

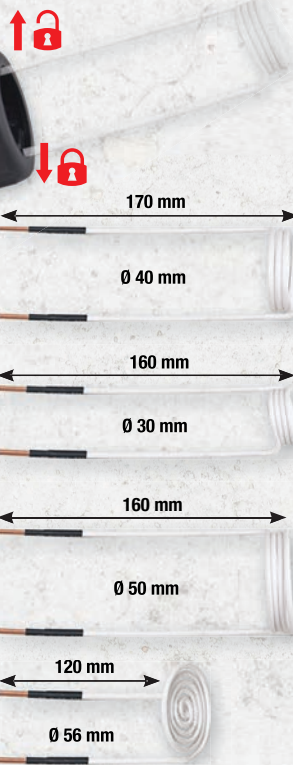

OPTIONAL 500.8605

100 x 100 mm

1940,-

500.8440 Induktionskudde



500.8605 Induktionsvärmepistolsats med snabbblås

6730,-



Mer information



OPTIONAL 500.8680

830,-

Induktionsspole med keramiskt skydd, formbar

500.8687

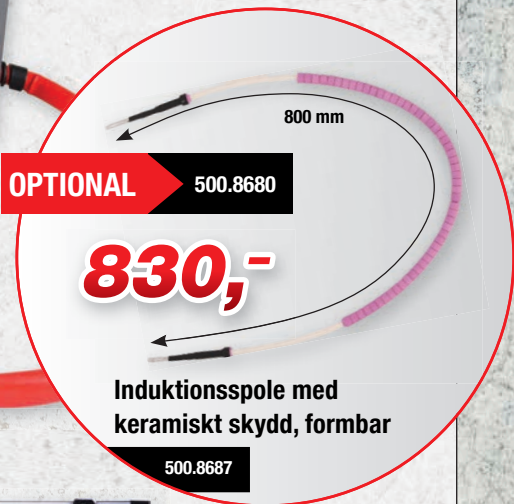
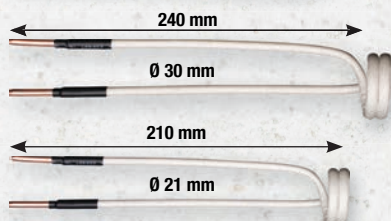
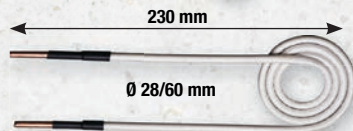

7880,-

500.8680 Induktionsvarmluftspistol-sats

TA ETT RIKTIGT BRA BESLUT NÄR DU BYTER FÖNSTER:
MINDRE PERSONALBEHOV, MER VINST!

ONE-MAN-SHOW VID FÖNSTERBYTE



ONE MAN
CUT 2

ALTERNATIV 1:

INKLUSIVE

6200,-

NEW

140.2670 **Universal en-man-drift-skiv-separeringsverktyg**

i **7**
Mer information

Skyddstavla, klar

6-kantsdrev, 6 mm

Högkvalitativ sugpump

2 styrrullar

Krok

Sugkraft: 110 kg

4-kants-tråd, 50 m

Nylon, 50 m

Införingssond för kaptråd, 290 mm

Standard-klämdragare

1 2 3 4

NEW

i **1**
Mer information

140.2641 **Skiv-skärtråd, med knutar**

25 m

270,-

NEW

i **1**
Mer information

140.2642 **Skiv-skärtråd, med knutar**

50 m

410,-



ALTERNATIV 2:



Mer information



ONE MAN CUT



Proffs-skyddstavla-set, 4 delar
2x 270x200 mm + 2x 450x300 mm

Kaptrådsfixering

Högkvalitativ sugpump

6-kantsdrev, 30 mm

Nylon, 50 m

ömlänkningsrulle

Sugtallrik Ø 50 mm

Sugtallrik Ø 50 mm

Kaptrådsfixering

4-kants-tråd, 50 m

Sugkraft: 110 kg

Avlastningsspak

Sugkraft: 110 kg

Införingssond för kaptråd, 290 mm

ömlänkningsrulle

Sugkraft: 110 kg

Sugtallrik Ø 150 mm

Skyddstavla, vinklad

- idealisk för korrekt och skonsam demontering av limmade vindrutor samt de flesta bak- och sidorutor
- med större styrullar och därigenom lägre kraftansträngning och minimering av risken för trådbrott

- Sprutdornhållare omedelbart framför vindrutan, därigenom elimineras i de allra flesta fallen kostnaderna för demonteringen av trimdelarna
- Enkel enmans-manövrering
- särskilt högkvalitativ pumpsug för säkert fäste på rutan

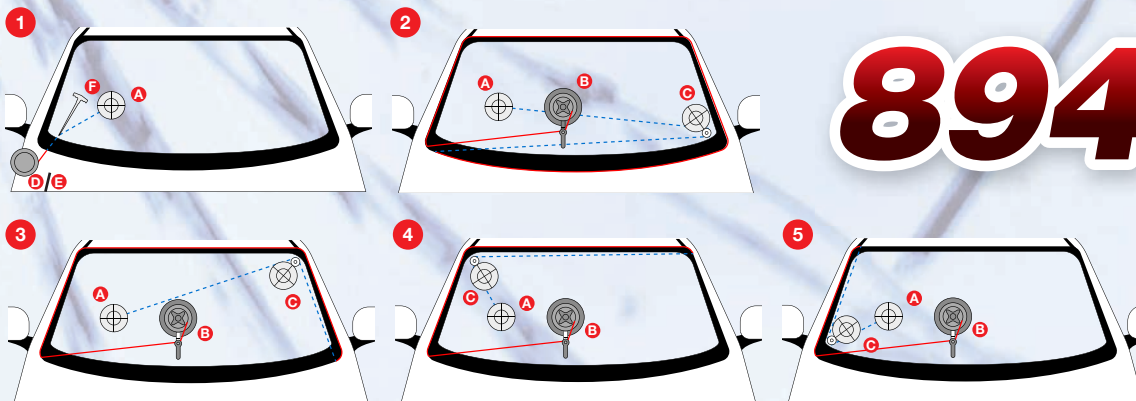

8940,-

INKLUSIVE



140.2630 Universalutrustning enmans för vindrutebyte

i  **37**
Mer information

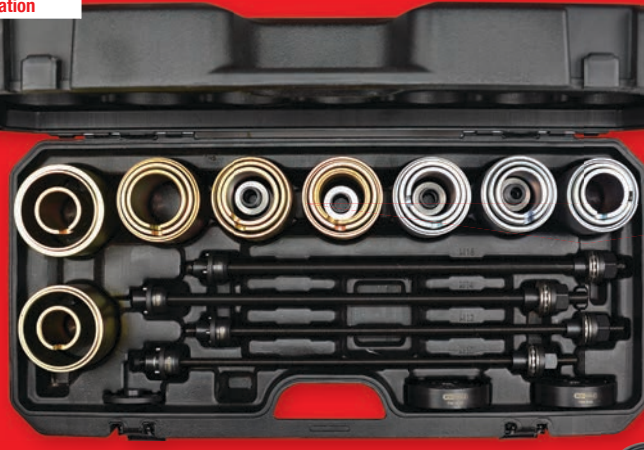

4470,-

**TOP
SELLER**

- 9 x  \emptyset 38 - 40 - 42
50 - 52 - 54
62 - 64 - 66 mm
- 13 x  \emptyset 34 - 36
44 - 46 - 48
56 - 58 - 60
68 - 70 - 72
75 - 80 mm
- 4 x  M10x1,5 - M12x2,0
M14x2,0 - M16x2,5
- \emptyset 1: 34 - 80 mm
- \emptyset 2: 44 - 90 mm
- 2 x 



700.1550 Tryck-och draghylsesats

i  **4**
Mer information









1200,-

150.1125 Inre styrled- specialnyckel-sats

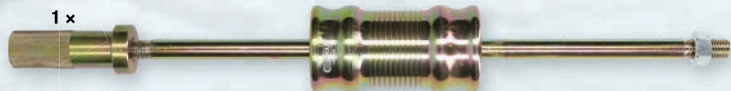
i  **30**
Mer information

**4,3
Kg**

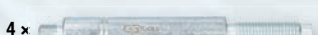

- 1 x  \emptyset 90 - 130 mm
- 3  ✓
- 1 x 
- 4  M14
- 4 x  M12 x 1,25
M12 x 1,5
- 4 x  M12 x 1,25
M14 x 1,5
- 1 x  M57 x 2
M18 x 2,5 x 230 mm

3350,-

700.1530 Universell hjulnavs- och länkaxelavdragarsats

i **1**
Mer information

ÄVEN FÖR DOT5.1, ENV4 OCH ENV6

• Dot3 ✓
• Dot4 ✓

210,-

Ø 20 mm
155 mm

Bromsvätskeprovare för DOT och ENV

150.1969

i **1**
Mer information

PUMP IT UP!

410,-

KSTOOLS
Druck-Zerstos
Pressure pump
Pulvérisateur

TOP SELLER

VITON®
FKM

**Speziell für
bromsrengörere**

150.8258 **Pumpsprejflaska för bromsrengöring**

i **2**
Mer information

L

160,-

240 mm

Universal kroksats, formbar

150.1935

i **12**
Mer information

1/2" 11,5 mm 14 mm 15 mm 20 mm AS 22 mm

1/4" 9 x 20 mm

3/8" 7 x 72 mm
7 x 92 mm
9 x 50 mm
11 x 100 mm

3/8" 7 x 25 - 8 x 25 mm

760,-

**Skivbromsskruvar-
specialhylsnyckel-sats**

150.2400 1/4" 3/8" 1/2"

i **2**
Mer information

**STEL FORM,
DÄRIGENOM
FORMSTABIL**

L

XL

**från
210,-**

240 mm
270 mm

Universal-kit med krokar för tung last

150.2235	L	240 mm	210,- SEK
150.2385	XL	270 mm	270,- SEK

NEW

i **1**
Mer information

**Bit-jackmutter för
insexskruvar på bromsok**

NEW

25 mm

3/8"

40,-

150.2498	6	25 mm	40,- SEK
150.2227	7	25 mm	40,- SEK
150.2228	8	25 mm	40,- SEK
150.2229	9	25 mm	40,- SEK

i  **41**
Mer information

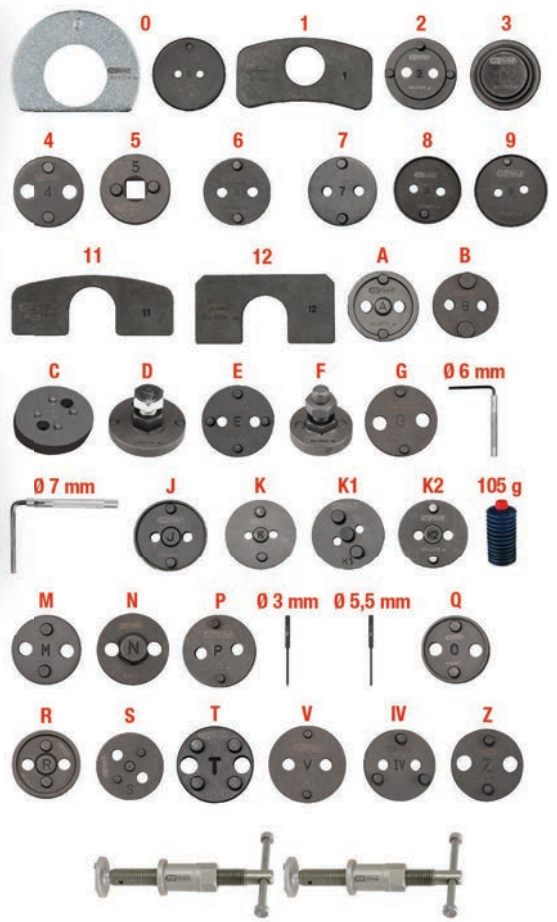
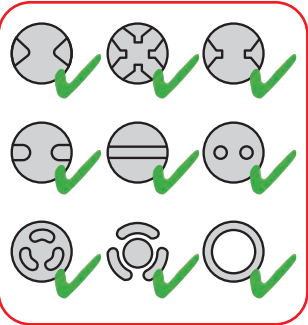

1500,-



150.1970 Bromskolv-återställningsverktyg-sats

i  **8**
Mer information

UNIVERSAL



För 95 % av alla fordon

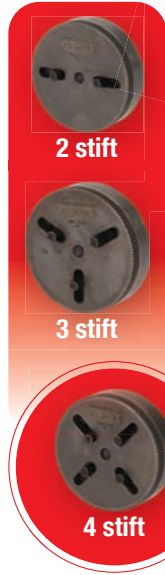
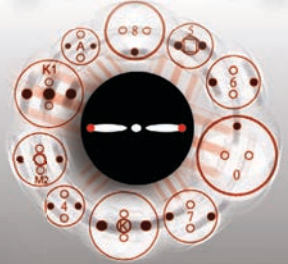

1940,-



150.2440 Universal bromskolv-återställnings-verktyg-sats

i  **3**
Mer information

för TESLA

1

2 Model 3 & Y

3 Model S & X

720,-

160.0695 Adaptersats för bromsluftning till Tesla

i  **1**
Mer information

360°

Min. 18 mm

Max. 70 mm

Min. 28 mm

TOP SELLER

760,-

universellt justerbar

160.0718 Universal ventilationsadapter, justerbar

i  **1**
Mer information

för TOYOTA & LEXUS

1 + 2

7,2 mm

240,-

160.0719 Universal-luftarrör-adapter för Toyota och Lexus

i  **1**
Mer information

311

1 BÖJA

2 DUPLICERA

3 RIKTA

4,75 mm (3/16")

6,35 mm (1/4")

OUT IN

450,-

120.1004 Bromsledningsriktverktyg/-bockverktyg



FÖR 80 % AV ALLA FORDON

Mer information

1

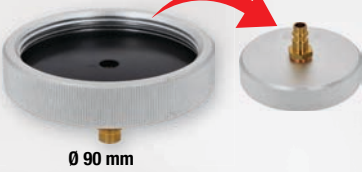

Ø 90 mm

3



Ø 55 mm

2



Ø 20 - 78 mm

4



E 20

5



0,2 L

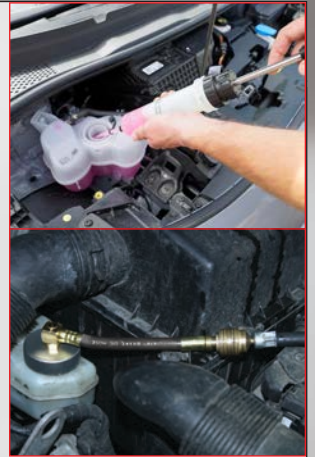

1140,-

160.0785

Adaptersats för bromsluftning



Mer information

Ø



för

Ø



för

1



54 mm

Mercedes
VAG
BMW
PSA
Volvo
Ford
Fiat
Porsche

9



52 mm

Dong Feng
Fengxing

2



58 mm

Hyundai
Kia
Mitsubishi
Renault
Subaru

10



40 mm

Nissan

3



55 mm

Buick

11



42 mm

Wuling

4



55 mm

Audi
Ford
Peugeot

12



50 mm

Suzuki

5



72 mm

Honda

13



55 mm

Soueast

6



52 mm

Toyota

14



59 mm

Nissan

7



54 mm

Buick
Cadillac
Ford
Mazda

15



86 mm

Mitsubishi
Soueast

8



50 mm

Chrysler
Dodge
Jeep

16



56 mm

Tesla



1720,-



17



Ø 27 mm

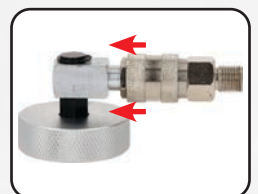

160.0815

Universal-luftarröradaptersats för bromsluftning

i  **6**
Mer information



1040,-



160.0725 Bromssystem-avlufningsnyckel-sats



i  **11**
Mer information



**TOP
SELLER**



1130,-



518.0320 Bromsavluftningsverktygssats för VAG

		DIN	SAE	4,75 mm	5,0 mm	6,0 mm	med rörböj	med rörkap	med röravgradare	mekanisk	med hydraulspindel	Handpump	i väskan
1	122.1215	✓	✗	✓	✗	✗	✗	✗	✗	✓	✗	✗	✗
2	122.1290	✓	✓	✓	✓	✓	✓	✓	✓	✗	✓	✗	✓
3	122.1260	✓	✓	✓	✓	✓	✗	✗	✗	✗	✗	✓	✓

1

i **4**
Mer information

STOP

FLAREFIX eco

760,-

4,75 mm

FLAREFIXeco 4,75 mm universal bromskonisk-sats

122.1215

2

i **16**
Mer information

FLAREFIX

DIN SAE

2530,-

max. 2t

4,75(3/16")
5 / 6mm

3,0-12,0 mm

3,0-6,0 mm

3,0-16,0 mm

4,75-5,0 mm, SAE

6,0 mm, SAE

4,75-5,0-6,0 mm, SAE-90°

4,75-5,0 mm, DIN

6,0 mm, DIN

M12x1,25

4,75 mm, 3/16"

5,0 mm

6,0 mm

122.1290 **FLAREFIX 1 universal bromslednings-koningsenhet-sats med hydraulcylinder**

3

i **11**
Mer information

FLAREFIX II

Hydraulic

DIN SAE

max. 2,5t

4,75(3/16")
5 / 6mm

M12 x 1,25 mm

4,75-5,0 mm, SAE

6,0 mm, SAE

4,75-5,0-6,0 mm, SAE-90°

4,75-5,0 mm, DIN

6,0 mm, DIN

M12x1,25

4,75 mm, 3/16"

5,0 mm

6,0 mm

4470,-

122.1260 **FLAREFIX 2 universell-bromslednings-flänsningsenhet-sats med hydraulcylinder**



Mer information



3/8"



1 för Ford/PSA



2 för BMW



3 för VAG



4 för Mercedes



5 för DAF/MAN



6 för GM



7 för Ford



8 för Ford



9 för Ford

360,-

3/8"

150.1040

Specialprofilsats för oljeservice med oljeavtappningskruvar i plast



Mer information



1/2"



63,8 mm

14

360,-

för **TESLA**

150.9469

Oljefilternyckel till Tesla



Mer information



för **OPEL**

Användningsområden / för:
Opel Astra K, Insignia B
Motorkod: F15DVC, F15DVH

1/2"

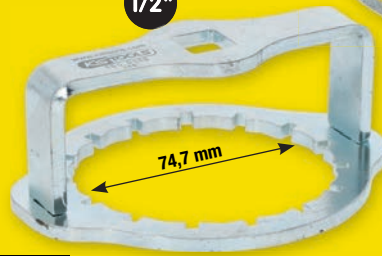

74,7 mm

15

210,-

150.9115

Oljefilternyckel för Opel

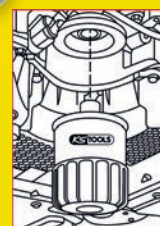

NEW



Mer information



1/2"

21 mm

Ø 63 - 102 mm

3/8"



65-14, 65/67-14, 66-6, 68-14, 73-14, 74-15, 74/76-15, 75/77-15,
76-8, 76-12, 76-14, 76-30, 78-15, 80-15, 80/82-15, 86-18, 86-16,
90-15, 92-10, 93-15, 93-36, 93-45, 95-15, 96-18, 100-15, 106-15,
108-15, 108-18

1500,-

150.9350

Oljeservicenylsats för oljefilter och filterlock



Mer information

TOP
SELLER



1500,-

150.9130 MASTER Oljepåfyllningstratt-sats med vridbar vinkelarm

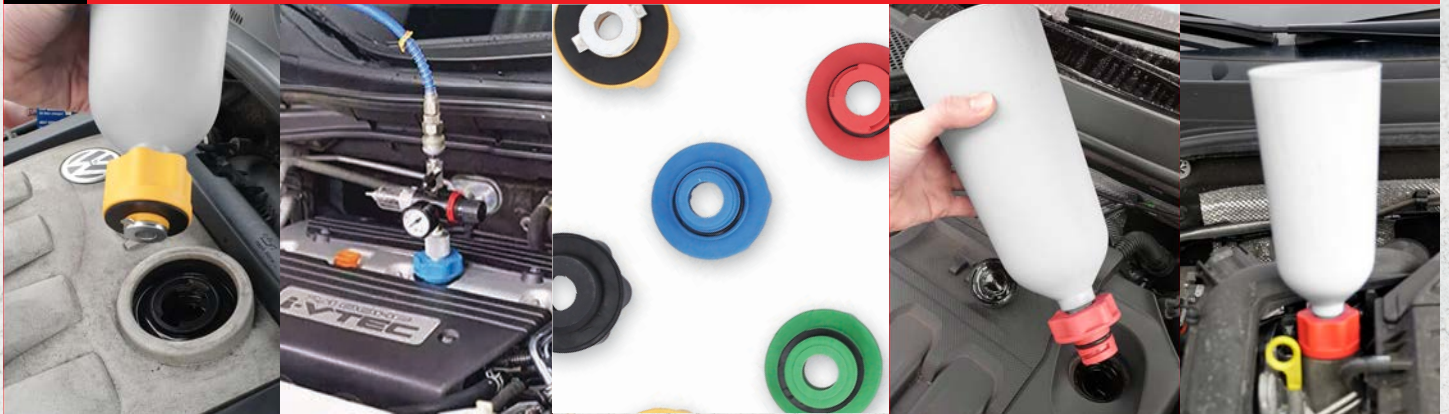

Mer information



MED BÖJBAR VINKELARM FÖR SVÅR ÅTKOMLIGA STÄLLEN

210,-



2,0 L

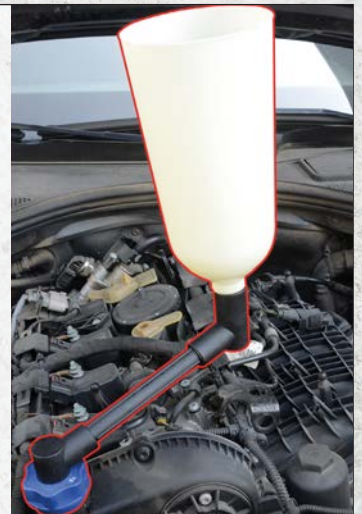

150.9155 Oljepåfyllningstratt med vridbar vinkelarm för VAG

i **7**
Mer information

1/4" \emptyset 17 mm \emptyset 20 mm

140 mm 197 mm 65 mm 100 mm

410,-

100.5100 Verktygssats för rengöring av ventilnäten för aluminiumfälgar

i **1**
Mer information

120,-

magnethölje i plast
 \emptyset 150 mm

800.0156

i **1**
Mer information

Fler raderskivor hittar du på sida 46

\emptyset 60 mm \rightarrow \emptyset 68 mm

RUBB EX
BY **KS TOOLS**

180,-

515.5471 Raderskiva för aluminiumfälgar, konisk

i **1**
Mer information

0 - 10 bar

400 mm

KALIBRERAD

1/4" PT

920,-

Kalibrerad tryckluft-däckfyllningsmätare

515.1960

i **1**
Mer information

0 - 12 bar

600 mm

1/4" PT

280,-

Tryckluft-däckpåfyllare

515.1950

i **6**
Mer information

SET-PRIS = 6X

870,-

515.5476

i **5**
Mer information

850,-

150.1070 Vulkaniseringsset för däck för personbilar, inklusive 100 mm gängor

60 x 100 mm

70 g

9 mm

OPTIONELLT
60 stycken

250,-

150.1072

i  **12**
Mer information

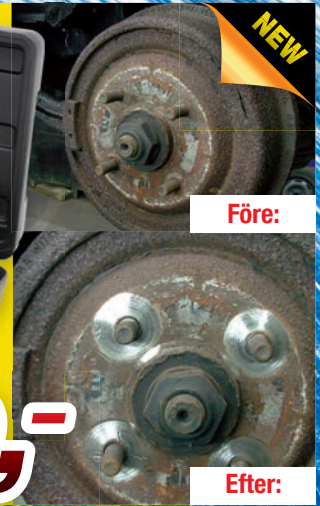

913.1800 Pinnbults-monterings-verktygs-sats

1510,-

i  **7**
Mer information

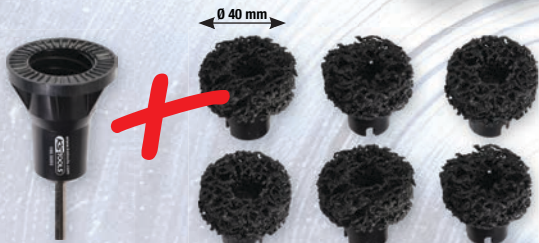

360,-

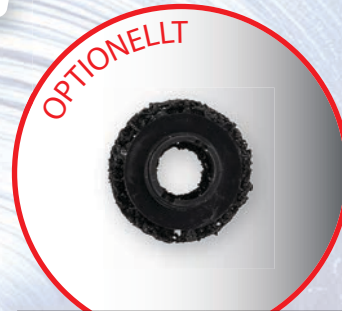

100.5085 Pinnbult-hjulnavslipsats, Ø 40 mm

100.5087 Ø 40 mm  6x 280,- SEK





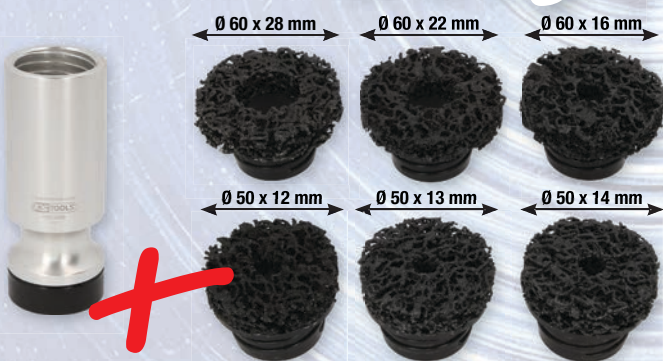

i  **7**
Mer information



710,-



100.5090 Pinnbult-hjulnavslipsats, Ø 50 / 60 mm

100.5091	Ø 50 x 12 mm	 10x	360,- SEK
100.5092	Ø 50 x 13 mm	 10x	360,- SEK
100.5093	Ø 50 x 14 mm	 10x	360,- SEK
100.5094	Ø 60 x 16 mm	 10x	560,- SEK
100.5096	Ø 60 x 22 mm	 10x	560,- SEK
100.5097	Ø 60 x 28 mm	 10x	560,- SEK



i  **2**
Mer information



1340,-



100.5080 Aluminium-hjulnavslipsats, Ø 150 mm, inre-Ø 90 mm

100.5077 Ø 150 mm  1x 520,- SEK

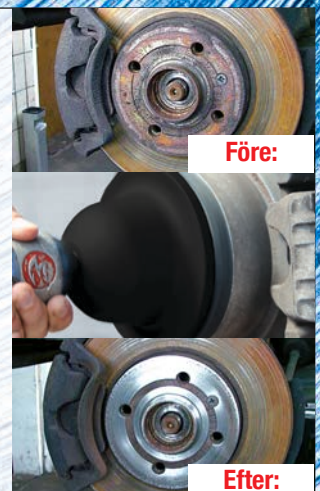

Mikrometerskala

500 mm

40-200 Nm

Skala med lupp

500 mm

1/2"

1/2"

från **960,-**

			Nm		
A	516.6042		1/2" 40-200 500 mm	960,- SEK	
B	516.6542		1/2" 40-200 500 mm	1370,- SEK	

Med kalibreringskonformitetsförklaring
DIN EN ISO 6789
Certifikat
Noggrannhet ±1%

1920,-

NEW

0,35 - 6,8 bar

1/2" 125 mm

1/2" 17 mm 19 mm 21 mm

M12 x 1,25 - M12 x 1,5
M14 x 1,25 - M14 x 1,5

110 mm

510 mm

Infinitool

Service Reminder 1/2" 20 - 200 Nm

Inklusive SERVICE REMINDER

72° 5°

1/2" 600 Nm 460 - 600 mm

1 2 3 4 5 6

72° 5°

516.2450



Mer information

EXTREMT BRA! OTROLIGT BILLIG!

TOP
SELLER



1/2"



1/2"

Med kalibrering-
konformitetsförklaring
DIN EN ISO 6789
Certifikat
Noggrannhet
±0,3%



515.2101



+



1/2"

15 mm

17 mm

19 mm

21 mm

22 mm

+ 4x

2860,-



Ø 150 mm

+



Ø 400 mm



Mer information

4820,-

NEW



Ø 345 mm

675 mm



4x

hållaren har plats för
upp till 4 rullar med
vikter

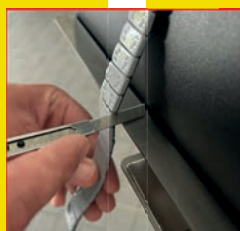

Mer information

4820,-

NEW



340 mm

Ø 345 mm

1120 mm

350 mm

4x

hållaren har plats för
upp till 4 rullar med
vikter

800.0100 Hållare för viktrullar med vägghållare

800.0105 Hållare för viktrullar med fot



15



Fälggläs-demonteringssats

Mer information



YouTube

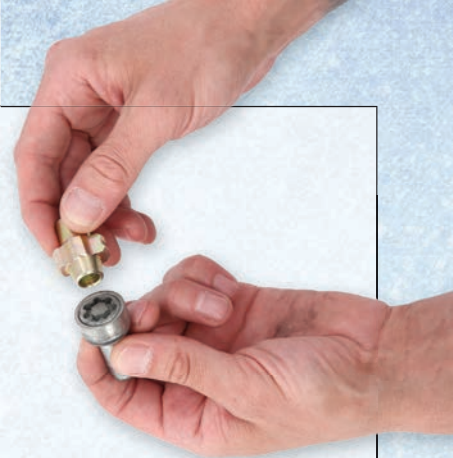

i med handsydd



14 mm

skumgummi



∅ 21,5 mm



∅ 21,5 mm



∅ 16 mm

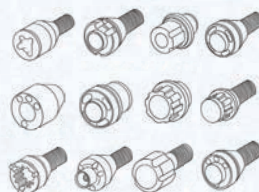

∅ 10,5 mm

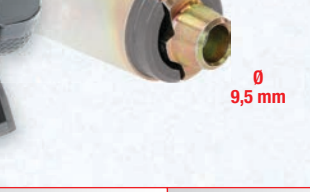
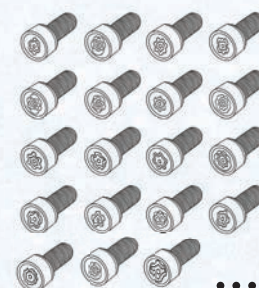

∅ 9,5 mm

UNIVERSALGENIAL - ANPASSAR SIG TILL VARJE PROFIL!

2090,-



kan användas på båda sidor

OPTIONELLT

100,-

913.1431



152 mm

143 mm



38 mm

1/2"

24 mm

3x



∅ 25 mm



∅ 30 mm

913.1430

i  **10**
Mer information

**Hjulsäkrings-
demonteringssats**

913.1480  18 - 19 - 20 - 21 - 22 - 23 - 24 - 25 mm

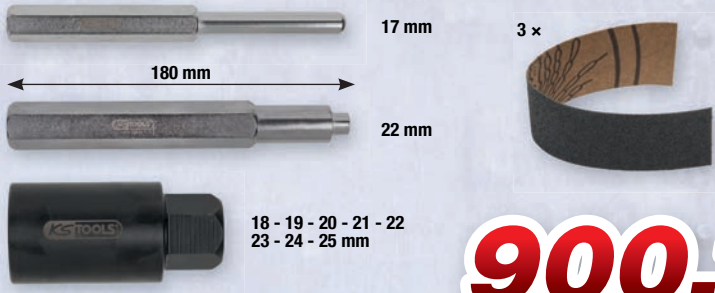
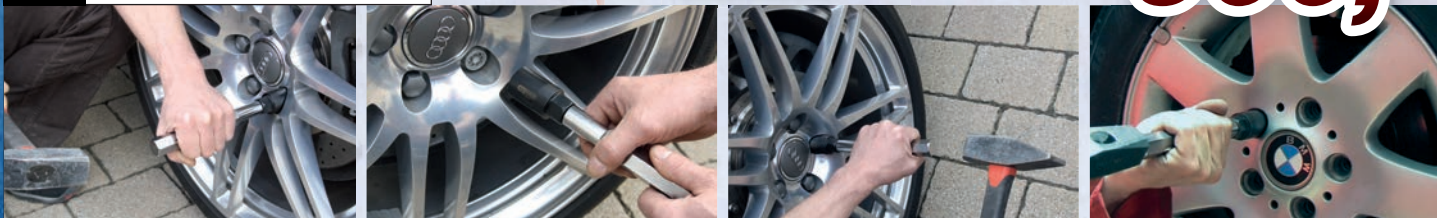

900,-

**TRASIGA
SKRUVAR?**

**INGA
PROBLEM!**

i  **3**
Mer information



600,-

**Spiral-profil-kraft-
hyls-sats**



913.1270   17 - 19 - 21 mm

i  **2**
Mer information  **för FORD**  = 



**Special-aluminiumfälg-krafthyls-sats för Ford,
18,5 / 19,5 / 20,5 / 21,5 mm**

410,-

515.0895   18,5 - 19,5 - 20,5 - 21,5 mm

i  **6**
Mer information



510,-

Special-aluminiumfälg-krafthyls-sats

515.0850   16,5 - 17,5 - 18,5 - 19,5 - 20,5 - 21,5 mm

i **3**
Mer information

17 mm 17 mm 17 mm
85 mm

180,-

515.0860 1/2" 3 x 17 mm

i **3**
Mer information

19 mm 19 mm 19 mm
85 mm

180,-

515.0855 1/2" 3 x 19 mm

i **3**
Mer information

17 mm 19 mm 21 mm
85 mm

210,-

515.0875 1/2" 17 - 19 - 21 mm

i **3**
Mer information

21 mm 19 mm 17 mm
85 mm

250,-

515.1070 1/2" 17 - 19 - 21 mm

i **3**
Mer information

EXTRA LÅNG

150 mm

21 mm 19 mm 17 mm

550,-

515.0865 1/2" 17 - 19 - 21 mm

i **5**
Mer information

15 mm 17 mm 19 mm 21 mm 22 mm
85 mm

360,-

515.0870 1/2" 15 - 17 - 19 - 21 - 22 mm

i **10**
Mer information

17 mm 15 mm 19 mm 22 mm 23 mm
85 mm

1040,-

1/2" 15 - 17 - 19 - 21
22 - 23 - 24 mm

515.0890 7/8" 17 mm MS21

21 mm 17 mm 21 mm 24 mm

i **17**
Mer information

15 mm 17 mm 19 mm 21 mm 22 mm 23 mm 24 mm
85 mm

2090,-

515.0885 1/2" 15 - 17 - 19 - 21 - 22 - 23 - 24 mm 7/8" 17 mm MS21 17 - 19 - 21 mm 18,5 / 19,5 - 20,5 / 21,5 - 17,5 / 22,5 mm

21 mm 19 mm 17 mm 18,5 mm 19,5 mm 20,5 mm 21,5 mm 17,5 mm 22,5 mm





med extra verktygsficka inuti för snabb hämtning



praktiskt placerade in- och utvändiga fickor



16L



40 kg



Vadderat handtag



i **328**
Mer information

850.0131 Universal-verktygsrycksäck

5510,-

13 x		1/4": 4 - 4,5 - 5 - 5,5 - 6 - 7 - 8 - 9 10 - 11 - 12 - 13 - 14 mm
10 x		1/2": 10 - 11 - 12 - 13 - 14 - 15 16 - 17 - 18 - 19 mm
21 x		1/4":
138 x		1/4":
29 x		1/4":
18 x		1/4":
10 x		1/4": 4 - 5 - 6 - 7 - 8 - 9 - 10 - 11 - 12 - 13 mm
10 x		1/4": 5/32" - 3/16" - 7/32" - 1/4" - 9/32" - 5/16" - 11/32" - 3/8" - 7/16" - 1/2"
2 x		1/4" - 1/2"
1 x		1/4"

1 x		150 mm
6 x		0,9 - 1,27 - 1,5 - 2 - 2,5 3 mm
1 x		1,5 - 2 - 2,5 - 3 - 4 - 5 - 6 8 - 10 mm
1 x		T10 - T15 - T20 - T25 - T27 - T30 T40 - T45 - T50
1 x		110 mm
1 x		150 mm
3 x		1/4": 50 - 100 mm 1/2": 125 mm
1 x		1/4"
2 x		1/4"
1 x		1/4"

10 x		8 - 10 - 11 - 12 - 13 - 14 - 15 17 - 19 - 22 mm
2 x		4 in 1: 8 x 10 + 12 x 13 mm 14 x 17 + 18 x 19 mm
1 x		0 - 28 mm
1 x		0 - 60 mm
1 x		0 - 45 mm
4 x		3 - 4 - 5,5 - 6,5 mm
3 x		PH1 - PH2 - PH3
6 x		T10 - T15 - T20 - T25 T27 - T30
1 x		6 mm
1 x		PH2

1 x		340 g
1 x		300 g
1 x		18 mm
1 x		10x 100 x 18 mm
1 x		5 m
1 x		Ø 4 mm
2 x		12 - 18 mm
1 x		160 mm
1 x		180 mm
1 x		200 mm

Er återförsäljare



KS Tools Werkzeuge und Maschinen GmbH
Seligenstädter Grund 10 - 12
63150 Heusenstamm
Mail: customerservice@kstools.com
Web: www.kstools.com
TYSKLAND

Priserna i denna broschyr ersätter alla tidigare priser. Endast försäljning via återförsäljare. Vi reserverar oss för eventuella tryckfel och tekniska ändringar. Alla priser i SEK exklusive moms gäller tills 2026-09-30.
En del bilder i denna broschyr är gjorda av AI eller har bearbetats digitalt och kan avvika från verkligheten.