

CHROMEplus® Flexible head drive handle

Article No.: 918.1292

EAN: 4042146079126

Promotional price: €39.50 *

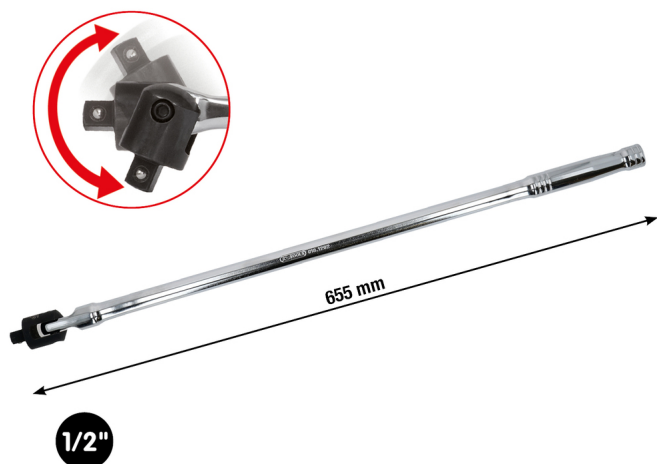

Description

- square drive adaptor to DIN 3120 / ISO 1174 with ball lock
- ideal for difficult to access areas
- protects ratchet and torque wrenches from overloading
- burnished head
- mirror polished
- chrome vanadium

Properties

Drive in inch:	1/2"
Function attribute 1:	protects torque wrenches
Image caption:	B
Material1:	finest chrome vanadium steel mirror polished finish
Norm:	DIN 3120, ISO 1174
Packaging contents:	1
Packaging height, mm:	50
Packaging length, mm:	665
Packaging width, mm:	73
Replacement head:	918.1292-1
Total length L in mm:	655.0
Weight [g]:	1420



Spare parts

Article No.	Quantity	Article	RRP: (ex. VAT)
918.1292-1	1 x	 1/2" Spare drive head, for flex.-handle 600 mm	€20.33 *