

Alternator key set, 13 pcs

Article No.: 150.3100

EAN: 4042146222751

RRP: €119.92 *



Description

- for the assembly and disassembly of free-running belt discs when changing alternator or the belt disc
- locking the alternator is done with the special bit
- actuation of the screws is carried out with the union nut
- also for checking screws
- allows for the releasing and securing of the central nut at the same time as counter holding the belt disc shaft
- internal square drive to DIN 3120 / ISO 1174 with ball reception
- suitable for a wide range of applications
- saves the removal of additional parts, e.g. cooler

Properties

Application in general: for the disassembly and assembly of free running pulleys

Inlay size: inlay 1/6 drawer

Material1: finest chrome vanadium steel

Norm: DIN 3120, ISO 1174

Packaging contents: 1

Packaging height, mm: 58

Packaging length, mm: 169

Packaging width, mm: 254

Parts in the set: 13

Total length L in mm: 190.0







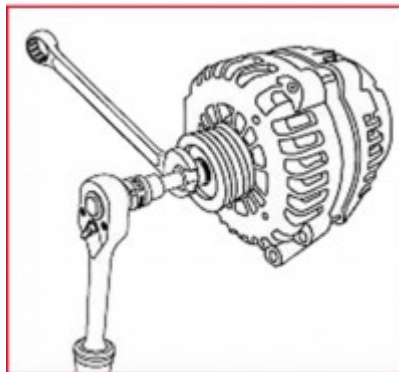





Weight [g]: 986

Width B: 188.0

height H: 35.0



Consists of

Article No.	Quantity		Article	RRP: (ex. VAT)
150.3101	1 x		1/2" V-Ribbed Alternator combination key Torx, T50	€22.92 *
150.3102	1 x		1/2" V-Ribbed Alternator combination key XZN, M10	€22.92 *
150.3103	1 x		Spline pulley key, 17mm, 33 teeth, bored	€17.44 *
150.3104	1 x		Spline pulley key, 22mm, 33 teeth, bored	€17.57 *
150.3105	1 x		22mm Adaptor for belt pulley wrench L=30mm	€12.08 *
150.3106	1 x		17mm Special adaptor, 4 mm L=30mm	€18.23 *
150.3107	1 x		10mm Spezial hexagon bit, 8mm, 75mm	€6.65 *
150.3108	1 x		10mm Spezial hexagon bit, 10mm, 75mm	€6.65 *
150.3109	1 x		10mm Spezial Bit spline XZN, M8, 75mm	€6.65 *
150.3110	1 x		10mm Spezial Bit spline XZN, M10, 75mm	€6.70 *
150.3111	1 x		10mm Spezial bit Torx, T40, 75mm	€6.65 *
150.3112	1 x		10mm Spezial bit Torx, T50, 75mm	€6.65 *
918.1271	1 x		1/2" Bit adaptor socket, for bits 10mm	€10.00 *