



performance Cross-beam for jack, 2000 kg

Article No.: 160.1045

EAN: 4042146982099

Promotional price: €125.00 *

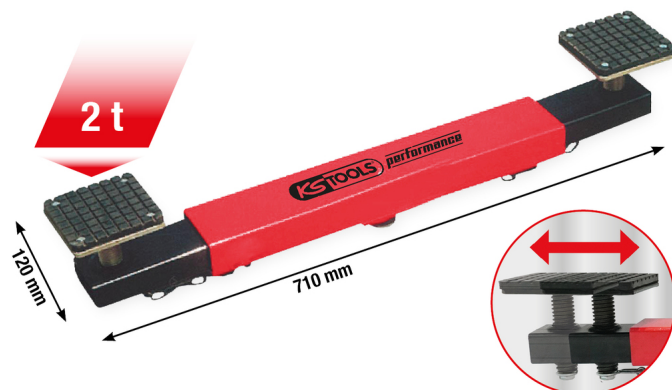

Description



- For lifting cars by attaching to the jack (mandrel diameter: 30 mm)
- For use with: 160.1060 and 160.1065
- Increases the stability of the jack and the raised vehicle
- Reduces the risk of bending the chassis
- The vehicles are lifted at the lower part of the body so that maintenance can be carried out on two wheels at the same time
- Provides exceptional stability for the raised vehicle at the front, rear and sides
- Rubber protection on both supports
- Extendible from 700 to 925 mm
- Spindle for adjusting the support height
- Sturdy steel construction for maximum durability



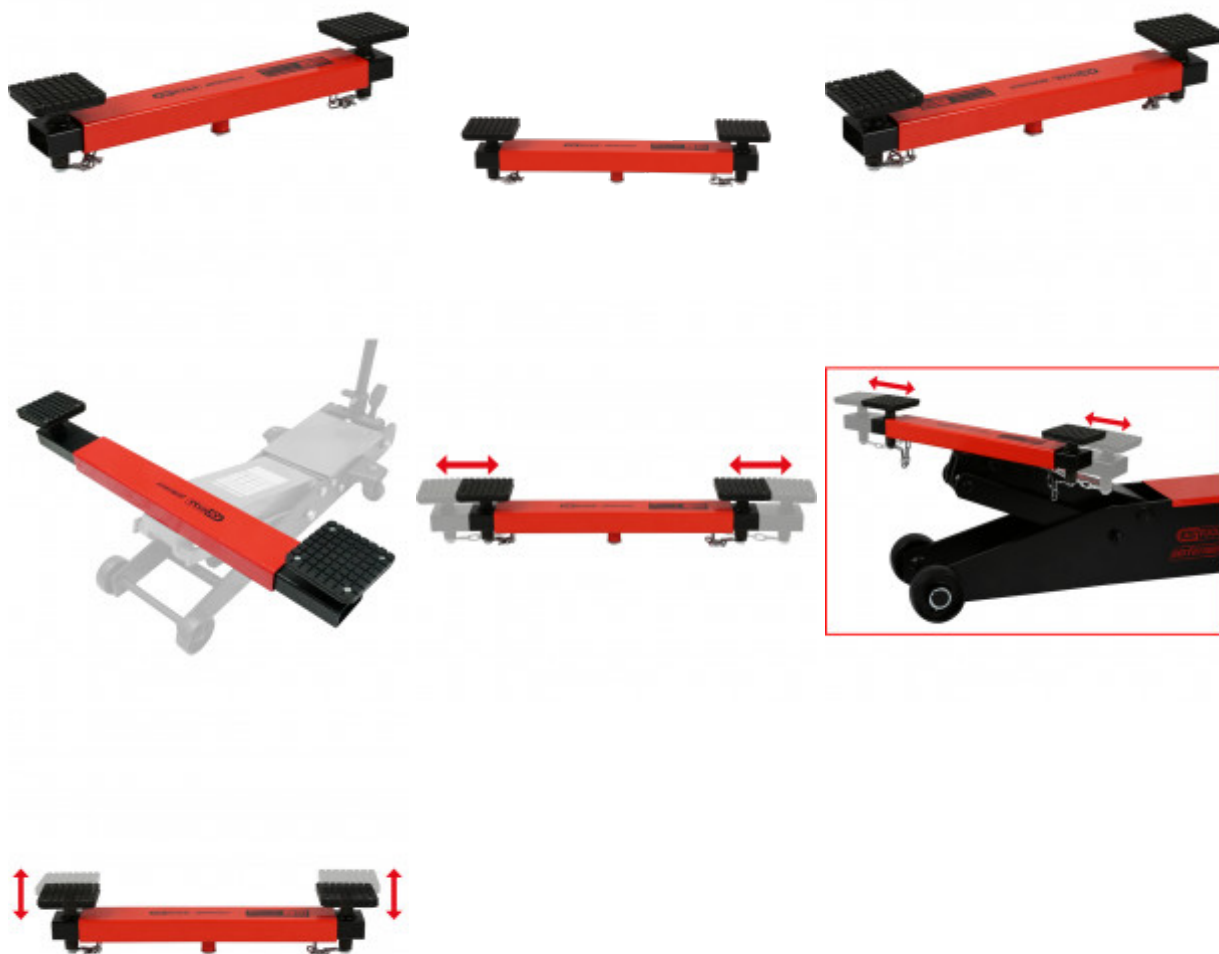



Properties

Adjustable range mm:	700 - 925
Height in mm:	130
Load capacity in kg:	2000
Packaging contents:	1
Packaging height, mm:	140
Packaging length, mm:	725
Packaging width, mm:	130
Total length mm:	710
Weight [g]:	11500
Width in mm:	120
max. Load t:	2,0



Spare parts

Article No.	Quantity	Article	RRP: (ex. VAT)
160.1045-R001P	1 x	 Cross Beam	€276.02 *
160.1045-R002P	8 x	 Bolt	€4.08 *
160.1045-R003P	2 x	 Rubber	€47.13 *

160.1045-R004P	2 x		Support Panel	€87.52 *
160.1045-R005P	2 x		Movable Beam	€239.70 *
160.1045-R006P	2 x		Washer	€2.66 *
160.1045-R007P	2 x		Bolt	€4.08 *
160.1045-R008P	2 x		Chain	€40.40 *
160.1045-R009P	1 x		Washer	€1.33 *