



SlimPOWER mini-pneumatic angled die grinder, 18.000 rpm

Article No.: 515.5540
 EAN: 4042146756256
 Promotional price: €184.00 *

Description





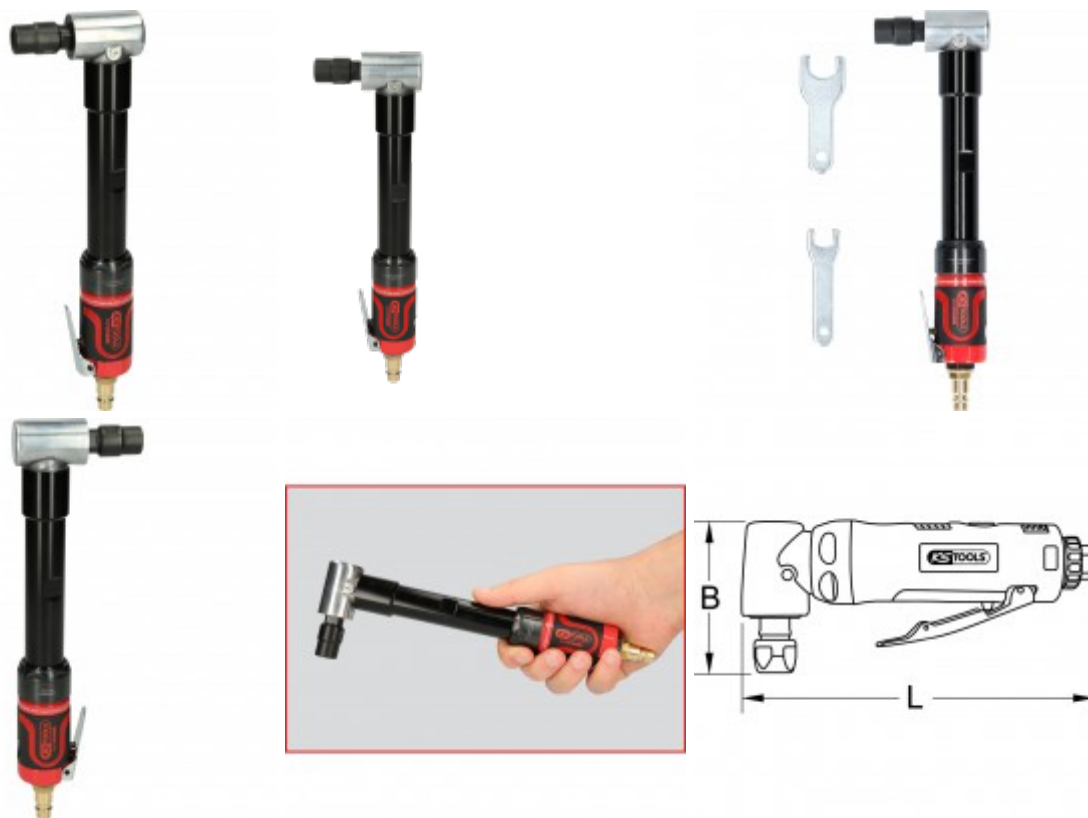

- angled design
- air exhaust through the handle
- for one handed operation with ergonomic design
- for HM mills, mini cutting discs and grinding heads with a 6 mm shaft
- ideal for grinding, polishing and engraving work
- for working in hard to access areas
- stepless speed regulation
- vibration dampened
- very compact construction
- includes 1/4" coupling connector
- robust housing





Properties



















Air consumption in l/min:	283
Capacity Watt:	220 Watt
Chuck:	6
Connection thread:	1/4"NPT
Form:	angled
Function attribute 1:	safety locking device
Measuring uncertainty vibration acceleration:	1.14
No Load current rpm:	18000
Noise performance level (dbA):	97.8
Noise pressure level (dbA):	86.8
Norm:	DIN EN ISO 28927-3
Operating Mode:	pneumatic
Operating pressure in bar:	max. 6,3 bar (90 psi)
Packaging contents:	1
Packaging height, mm:	55
Packaging length, mm:	265
Packaging width, mm:	94
Total length L in mm:	270.0
Vibration acceleration:	< 6,5
Weight [g]:	700
Width B:	70
min. Tube diameter:	3/8" - 10 mm



Spare parts

Article No.	Quantity		Article	RRP: (ex. VAT)
515.5410-R003P	1 x		Collet	€11.39 *
515.5410-R013P	2 x		Rotor blade	€2.04 *
515.5410-R016P	1 x		Ball bearing	€15.40 *
515.5415-R003P	1 x		Ball bearing	€15.93 *
515.5420-R001P	1 x		Collet nut	€14.33 *
515.5420-R003P	1 x		Shaft	€1.77 *
515.5420-R006P	1 x		Spindle gear	€36.36 *

515.5420-R007P	1 x		Ball bearing	€15.40 *
515.5420-R014P	1 x		Spanner	€4.58 *
515.5475-R007P	1 x		Ball bearing	€15.40 *
515.5505-R001P	1 x		Plug	€3.66 *
515.5505-R002P	1 x		O-Ring	€1.32 *
515.5505-R003P	1 x		Spring	€1.32 *
515.5505-R004P	1 x		O-Ring	€1.32 *
515.5505-R005P	1 x		Valve stem	€2.88 *
515.5505-R006P	1 x		O-Ring	€1.32 *
515.5505-R007P	1 x		Valve bushing	€4.44 *
515.5505-R008P	1 x		Air inlet bushing	€7.94 *
515.5505-R009P	1 x		Exhaust deflector	€1.98 *
515.5505-R010P	1 x		Muffler	€1.32 *
515.5505-R011P	1 x		O-Ring	€1.32 *
515.5505-R012P	1 x		Throttle lever	€3.15 *
515.5505-R013P	1 x		Lever pin	€0.93 *
515.5505-R014P	1 x		Motor housing	€37.25 *
515.5505-R015P	1 x		Rear end plate	€15.86 *

515.5505-R016P	1 x		Cylinder	€15.86 *
515.5505-R017P	1 x		Pin	€0.93 *
515.5525-R009P	1 x		Angle Head Housing	€31.54 *
515.5525-R010P	1 x		Clamp Nut	€9.88 *
515.5530-R001P	4 x		Rotor blade	€1.98 *
515.5530-R002P	1 x		Rotor	€19.74 *
515.5530-R003P	1 x		Rotor Collar	€1.45 *
515.5530-R004P	1 x		Front end plate	€8.84 *
515.5530-R005P	1 x		Ball bearing	€11.06 *
515.5530-R010P	1 x		Spanner	€3.29 *
515.5535-R001P	1 x		Pinion gear	€35.43 *
515.5535-R002P	1 x		Housing Cap	€17.78 *
515.5535-R003P	1 x		Spindle	€23.76 *
515.5540-R001P	1 x		Nut	€3.92 *
515.5540-R002P	1 x		Clamp Nut	€9.88 *
515.5540-R003P	1 x		Nut	€3.92 *
515.5540-R004P	1 x		Washer	€1.32 *
515.5540-R005P	1 x		Extension Spindle	€39.32 *

515.5540-R006P

1 x



Extension Housing

€59.04 *