

Druckluft-Bandschleifer, 150mm

Artikel-Nr.: 515.3549

EAN: 4042146336137

Aktionspreis: 184,00 € *

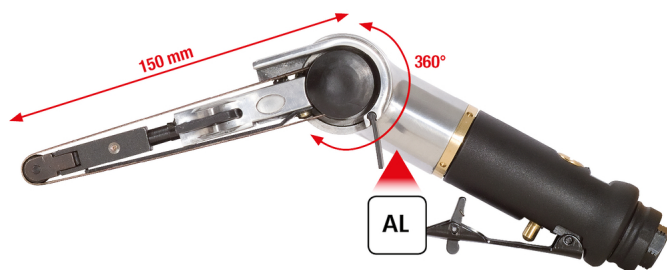

Beschreibung





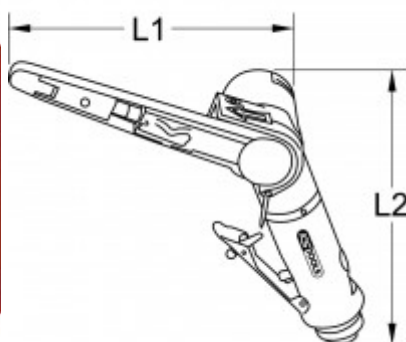

- mit rutschfestem Soft-Grip-Handgriff
- Ablufführung durch den Handgriff
- Arbeitskopf um 360° verstellbar
- Arretierung für schnellen Schleifbandwechsel
- ideal für schmale Flächen (10 mm Bandbreite)
- Betätigungshebel mit Sicherheitsarretierung
- mit stufenloser Geschwindigkeitsregulierung
- Drehzahl-Regulierung durch Regulierungsschraube
- vibrationsgedämpft
- kälteisolierter Handgriff
- inklusive 1/4" Kupplungsstecker
- leichtes Aluminium-Gehäuse
- für Schleifbänder mit der Länge 330 mm



















Eigenschaften











Anschlussgewinde:	1/4"PT
Bandbreite mm:	10.0
Bandgeschwindigkeit:	1188 m/min
Betriebsart:	pneumatisch
Betriebsdruck in bar:	max. 6,3 bar (90 psi)
Gesamtlänge L1 in mm:	150.0
Gewicht [g]:	800
Handgriff:	kälteisolierter Handgriff
Leerlaufdrehzahl in U/min:	18000
Luftverbrauch in l/min:	142
Material1:	Aluminium
Messunsicherheit Vibrationsbeschleunigung:	0.59
Norm:	DIN EN ISO 28927-3
Schalldruckpegel (dbA):	73
Schallleistungspegel (dbA):	81
Teillänge L2 in mm:	170.0
Verpackungsbreite mm:	143
Verpackungshöhe mm:	65
Verpackungsinhalt:	1
Verpackungslänge mm:	315
Vibrationsbeschleunigung:	< 1,01
min. Schlauchdurchmesser:	3/8" - 10 mm











Ersatzteile

Artikel-Nr.	Anzahl		Artikel	Listenpreis (exkl. MwSt.)
515.3549-R001P	1 x		Motorverschraubung	13,11 € *
515.3549-R002P	1 x		O-Ring für Motoverschraubung	2,24 € *
515.3549-R003P	1 x		Kugellager	15,15 € *
515.3549-R004P	1 x		Hintere Rotorplatte	13,53 € *
515.3549-R005P	1 x		Zylinder	44,35 € *
515.3549-R006P	1 x		Rotor	28,79 € *
515.3549-R007P	1 x		Rotorblatt	1,70 € *

515.3549-R008P	1 x		Einlegekeil	2,24 € *
515.3549-R009P	1 x		Abstandsring	2,24 € *
515.3549-R010P	1 x		Vordere Rotorplatte	13,53 € *
515.3549-R011P	1 x		Kugellager	19,57 € *
515.3549-R012P	1 x		Gehäuse	72,55 € *
515.3549-R013P	1 x		Gehäuse O-Ring	1,56 € *
515.3549-R014P	1 x		Konterring	19,57 € *
515.3549-R015P	1 x		Ventil O-Ring	1,27 € *
515.3549-R016P	1 x		Luftregulierung	5,27 € *
515.3549-R017P	1 x		O-Ring	1,27 € *
515.3549-R018P	1 x		Ventilstift	5,27 € *
515.3549-R019P	1 x		O-Ring für Ventilstift	1,83 € *
515.3549-R020P	1 x		Sprengring	1,83 € *
515.3549-R021P	1 x		Ventilgehäuse	93,73 € *
515.3549-R022P	1 x		Dichtungsring	7,74 € *
515.3549-R023P	1 x		Ventilstift für Lufteinlass	7,21 € *
515.3549-R024P	1 x		Ventilfeder	1,56 € *
515.3549-R025P	1 x		Dämpfer	5,81 € *

515.3549-R026P	1 x		O-Ring für Lufteinlass	2,52 € *
515.3549-R027P	1 x		Lufteinlass	7,88 € *
515.3549-R028P	1 x		Abluftführung	15,32 € *
515.3549-R029P	1 x		Splint für Betätigungshebel	1,27 € *
515.3549-R030P	1 x		Betätigungshebel	9,82 € *
515.3549-R031P	1 x		Abschlusskappe	4,17 € *
515.3549-R032P	1 x		Mutter M6	1,56 € *
515.3549-R033P	1 x		Unterlegscheibe	1,69 € *
515.3549-R034P	1 x		Antriebsscheibe	19,57 € *
515.3549-R035P	1 x		Schleifbandschutz	69,78 € *
515.3549-R036P	1 x		Innensechskantschraube	1,98 € *
515.3549-R037P	1 x		Splint für Rückhaltehebel	1,69 € *
515.3549-R038P	1 x		Schraube für Schleifbandführung	1,27 € *
515.3549-R039P	1 x		Staubschutz	4,17 € *
515.3549-R040P	1 x		Feder für Rückhaltehebel	1,69 € *
515.3549-R041P	1 x		Pin für Rückhaltehebel	1,69 € *
515.3549-R042P	1 x		Rückhaltehebel	7,05 € *
515.3549-R043P	1 x		Schleifbandführung	5,68 € *

515.3549-R044P	1 x		Schleifbandspannungsfeder	1,27 € *
515.3549-R045P	1 x		Riemenspanner-Stab	42,01 € *
515.3549-R046P	1 x		Splint	0,86 € *
515.3549-R047P	1 x		Feder	1,28 € *
515.3549-R048P	1 x		Halter für Riemenrolle	32,20 € *
515.3549-R049P	1 x		Schraube für Halter	1,15 € *
515.3549-R050P	1 x		Stellschraube	2,00 € *
515.3549-R051P	1 x		Welle für Riemenrolle	2,92 € *
515.3549-R052P	1 x		Riemenrolle	38,84 € *