

## Vario-Muttern- und Kappenschlüssel-Satz, 14-tlg

Artikel-Nr.: 450.0190  
 EAN: 4042146327128  
 Aktionspreis: 571,50 € \*

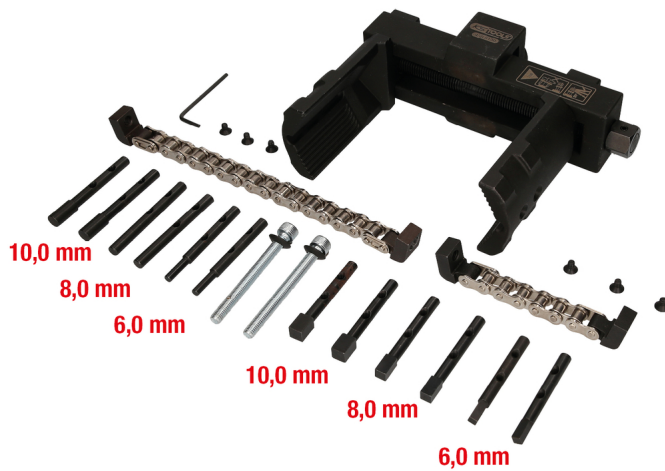

### Beschreibung

- extra schwere Ausführung
- zur Montage und Demontage von Variomuttern
- drehmomentgenauer Anzug über 3/4" Antriebsvierkant möglich
- sicherer Halt durch Spannschrauben und Adapterführung am Grundgerät
- Nut- bzw. Bohrungsabstand maximal 145 mm
- inklusive Spannkette
- schlanke Bauform
- anwendbar bei engen Platzverhältnissen
- ideal einsetzbar bei Spezialmutter und Kappen
- Spezial-Werkzeugstahl









**Anwendungsgebiete / für:** 6-kant-, 8-kant-, Nut- und Rundmuttern.

### Eigenschaften

<b>Gewicht [g]:</b>	4800
<b>Material1:</b>	Spezial-Werkzeugstahl
<b>Teile im Satz:</b>	14
<b>Verpackungsbreite mm:</b>	248
<b>Verpackungshöhe mm:</b>	96
<b>Verpackungslänge mm:</b>	291



**Bestehend aus**

Artikel-Nr.	Anzahl		Artikel	Listenpreis (exkl. MwSt.)
450.0191	1 x		Vario-Mutter- und Kappenschlüssel, brüniert	835,54 € *
450.0192	1 x		Rundadapter, 6mm, 2er Pack, brüniert	77,42 € *
450.0193	1 x		Rundadapter, 8mm, 2er Pack, brüniert	77,42 € *
450.0194	1 x		Rundadapter, 10mm, 2er Pack, brüniert	77,42 € *
450.0195	1 x		Vierkantadapter, 6mm, 2er Pack, brüniert	83,68 € *
450.0196	1 x		Vierkantadapter, 8mm, 2er Pack, brüniert	83,68 € *
450.0197	1 x		Vierkantadapter, 10mm, 2er Pack, brüniert	83,68 € *
450.0198	1 x		Spannkette	310,75 € *